













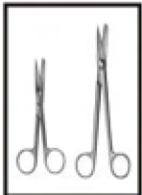

# SURGICAL INSTRUMENTS

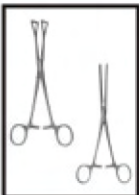
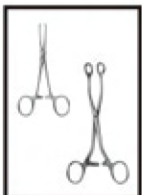
We are Manufacturers & Exporters of Surgical Instruments

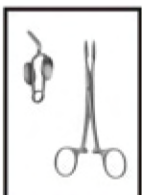
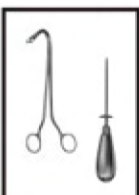
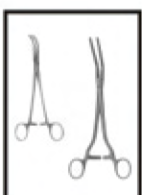









# Table Of Contents

Diagnostic, Anaesthesia and other instruments	Page Seite 1 - 10		Probes, Pocket Instruments sets	Page Seite 66 - 68	
Scalpels, knives and Scalpel Handles	11 - 14		Wound Retractors	69 - 80	
Scissors	15 - 31		Self-Retaining Retractors, Abdominal Retractors	81 - 85	
Dissecting-and Tissue Forceps	32 - 42		Abdominal Surgery Intestinal-and Rectal Instruments	86 - 93	
Sponge, Dressing and Tissue Grasping Forceps Towel Clamps	43 - 48		Gall Bladder-, Liver-and Spleen Instruments	94 - 96	
Vessel Clips, Bulldog Clamps Haemostatic Forceps	49 - 57		Genito-Urinary Instruments and Trocars	97 - 100	
Ligature, Hysterectomy and Compression Forceps Vaginal Clamps	58 - 60		Vaginal Specula and Uterine Dilators	101 - 106	
Needle Holders, Suture Instruments	61 - 65		Uterine Probes, Uterine Dressing-, Polypus-and Ovum Forceps	107 - 109	





# Table Of Contents

	Page Seite		Page Seite	
<b>Biopsy Instruments and Curettes</b>	110 - 116		<b>Suction Instruments</b>	158 - 166
<b>Obstetrics and Tracheotomy</b>	117 - 119			
<b>Cardiovascular-and Thoracic Surgery</b>	120 - 128			
<b>Bone Punches, Rongeurs</b>	129 - 134			
<b>Elevators, Bone Levers, Raspatories, Bone Files, Bone Curettes</b>	135 - 139			
<b>Mallets, Chisels and Gouges</b>	140 - 141			
<b>Bone Holding Forceps, Bone Rongeurs, Bone Cutting Forceps</b>	142 - 146			
<b>Plaster Instruments</b>	147 - 157			



## Percussion Hammers and Aesthesiometers





# Stethoscopes



**01-110**  
PINARD (Aluminum)  
Size: 155 mm

½



**01-111**  
wooden  
Size: 145 mm

½



**01-112**  
BOWLES  
Stethoscope  
with diaphragm

¼



**01-113**  
ANESTOPHON

½



**01-114**  
FORD-BOWLES  
Dual chest piece  
with two outlets

¼



**01-115**  
BOWLES

¼

## Head Mirrors and Head Bands

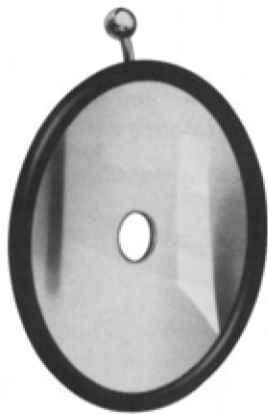

**01-116**  
ZIEGLER  $\varnothing$  90mm  
head mirror only  
with rubber coating

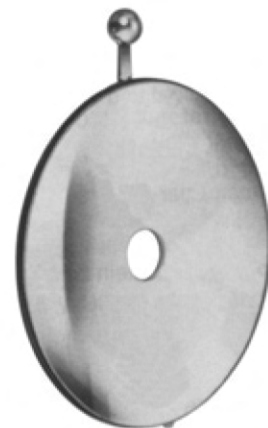

**01-117**  
ZIEGLER  $\varnothing$  90mm  
head mirror only  
with metal coating



**01-118**  
ZIEGLER  
head band of plastic black

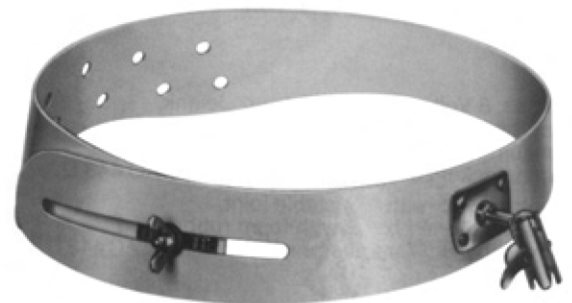

**01-120**  
MURPHY  
head band of celluloid, white

**01-119**  
ZIEGLER  
head band of plastic white

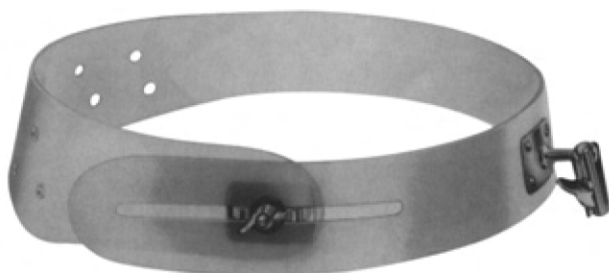

**01-121**  
head band of plastic,  
white, soft pattern



**01-122**  
head mirror with black  
plastic head band.



# Tongue Depressors

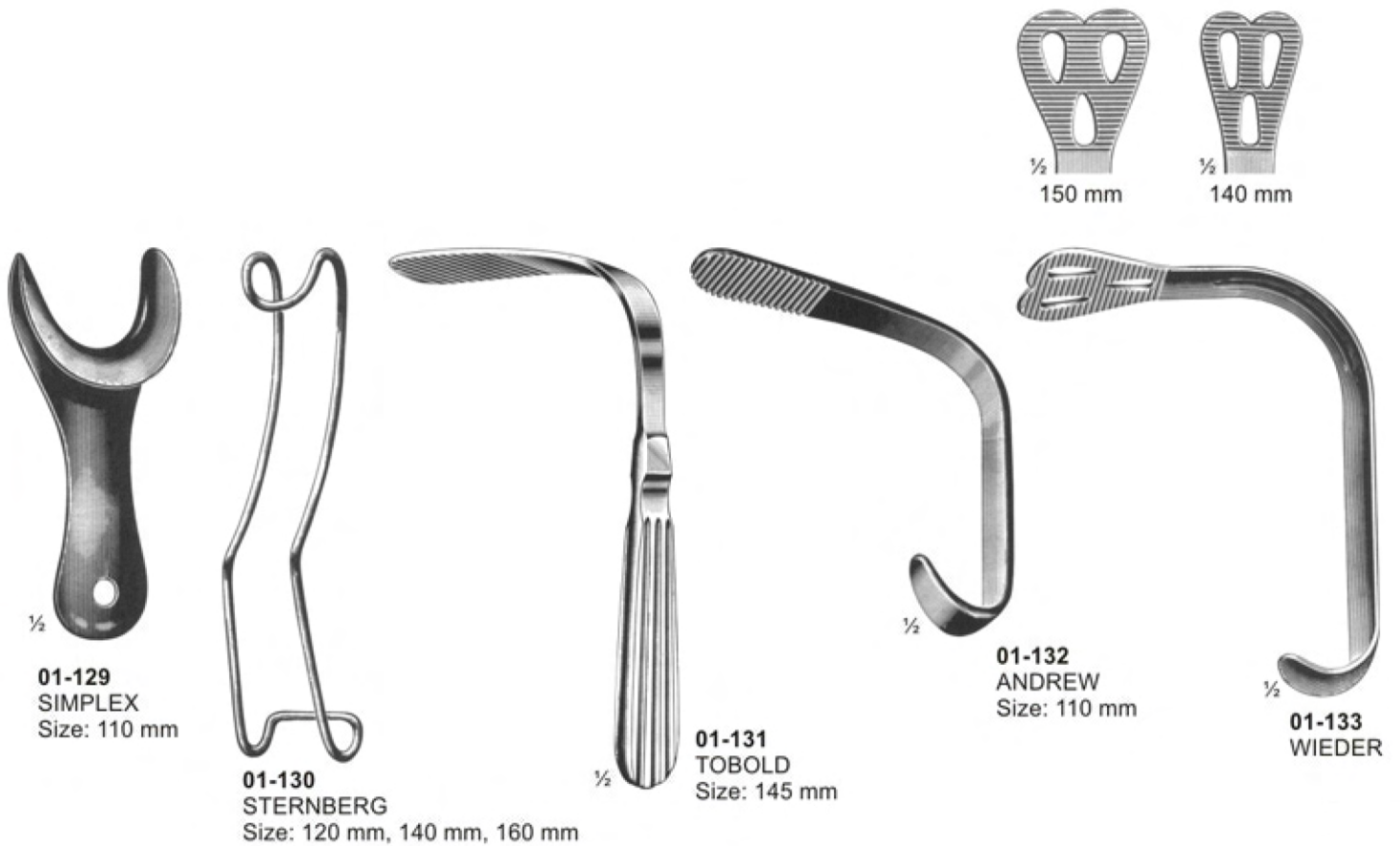
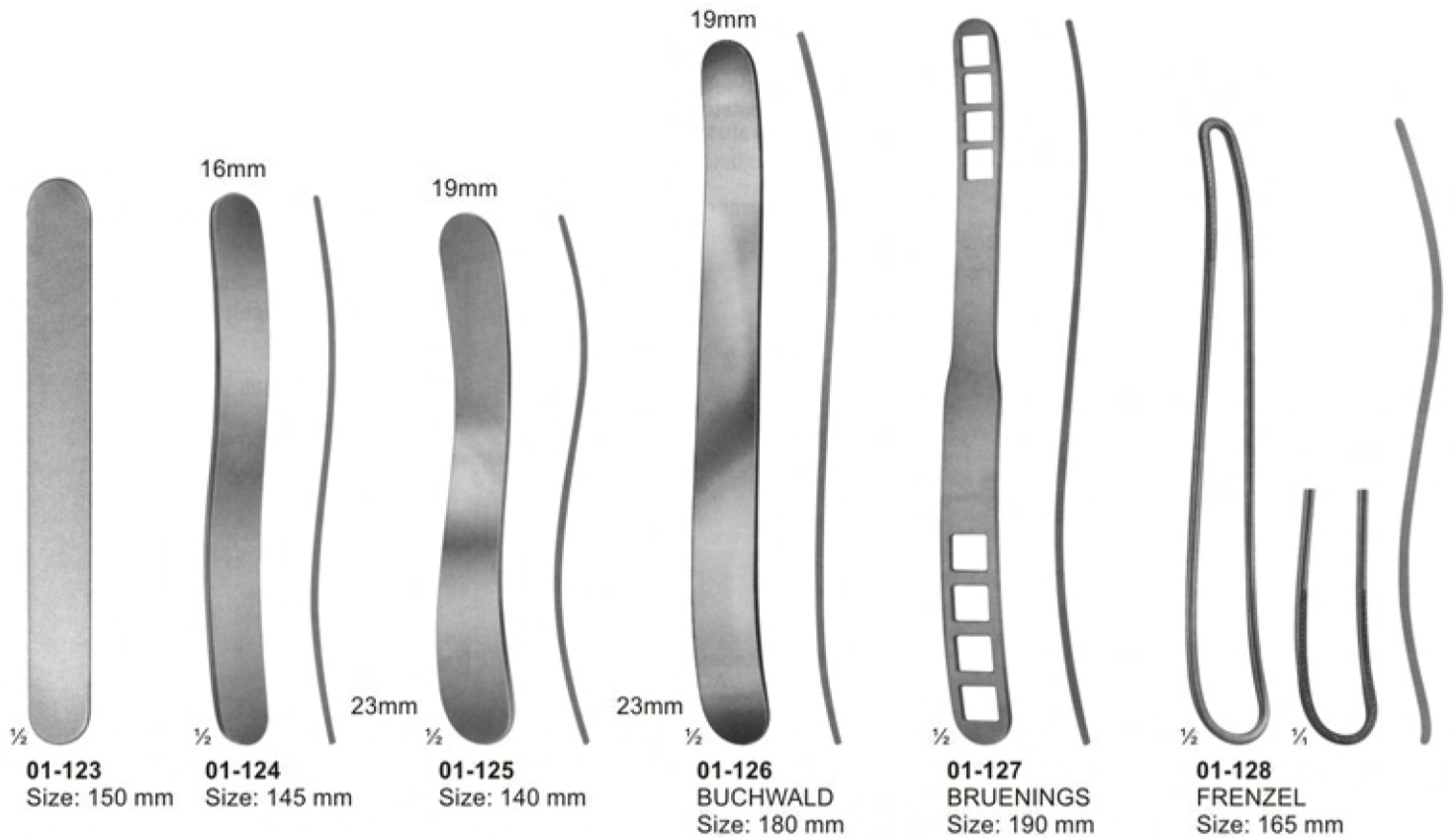

## Instruments for Anaesthesia and Tongue Forceps



**01-134**  
SCHIMMELBUSCH  
Ether mask



**01-135**  
HEISTER  
Mouth gag  
Size: 130 mm



**01-136**  
FERGUSSON-ACKLAND  
Mouth gag  
Size: 145 mm



**01-137**  
DENHARDT  
Mouth gag with silicon  
inserts, interchangeable  
Size: 125 mm



**01-138**  
ROSER KOENIG  
Mouth gag  
Size: 160 mm, 185 mm

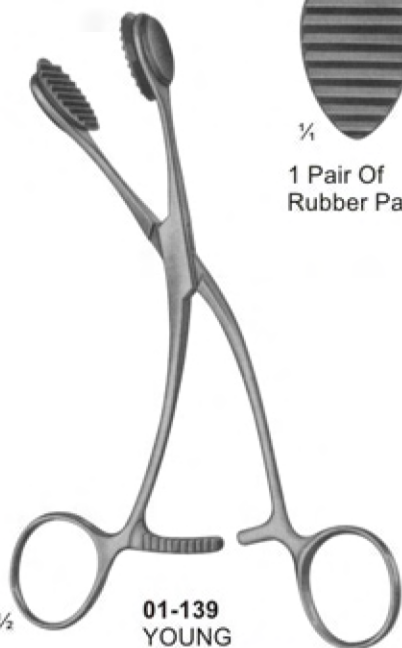

**01-139**  
YOUNG  
Size: 165 mm



1 Pair Of  
Rubber Pads

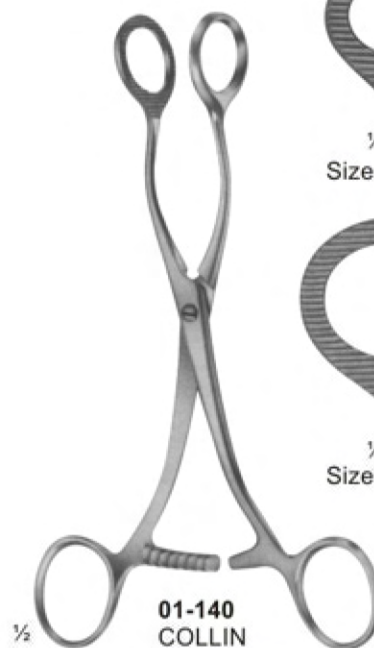

**01-140**  
COLLIN  
Size: 160 mm,  
170 mm



Size: 160 mm



Size: 170 mm

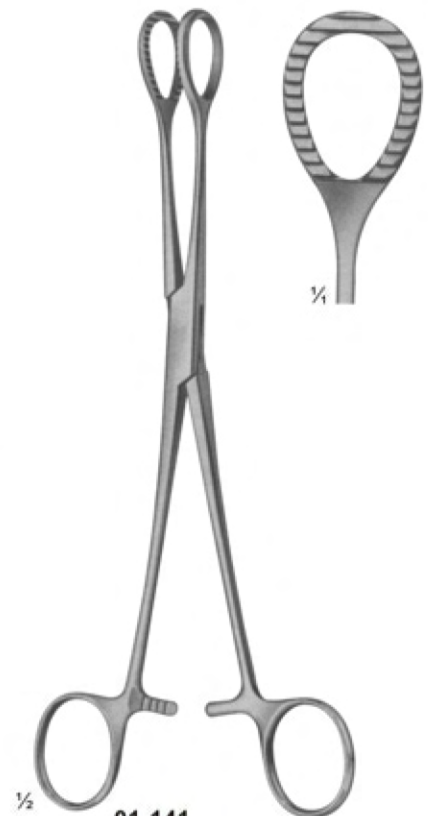

**01-141**  
HEYWOOD-SMITH  
modif. Size: 215 mm



# Blood Lancets and Laryngeal Mirrors

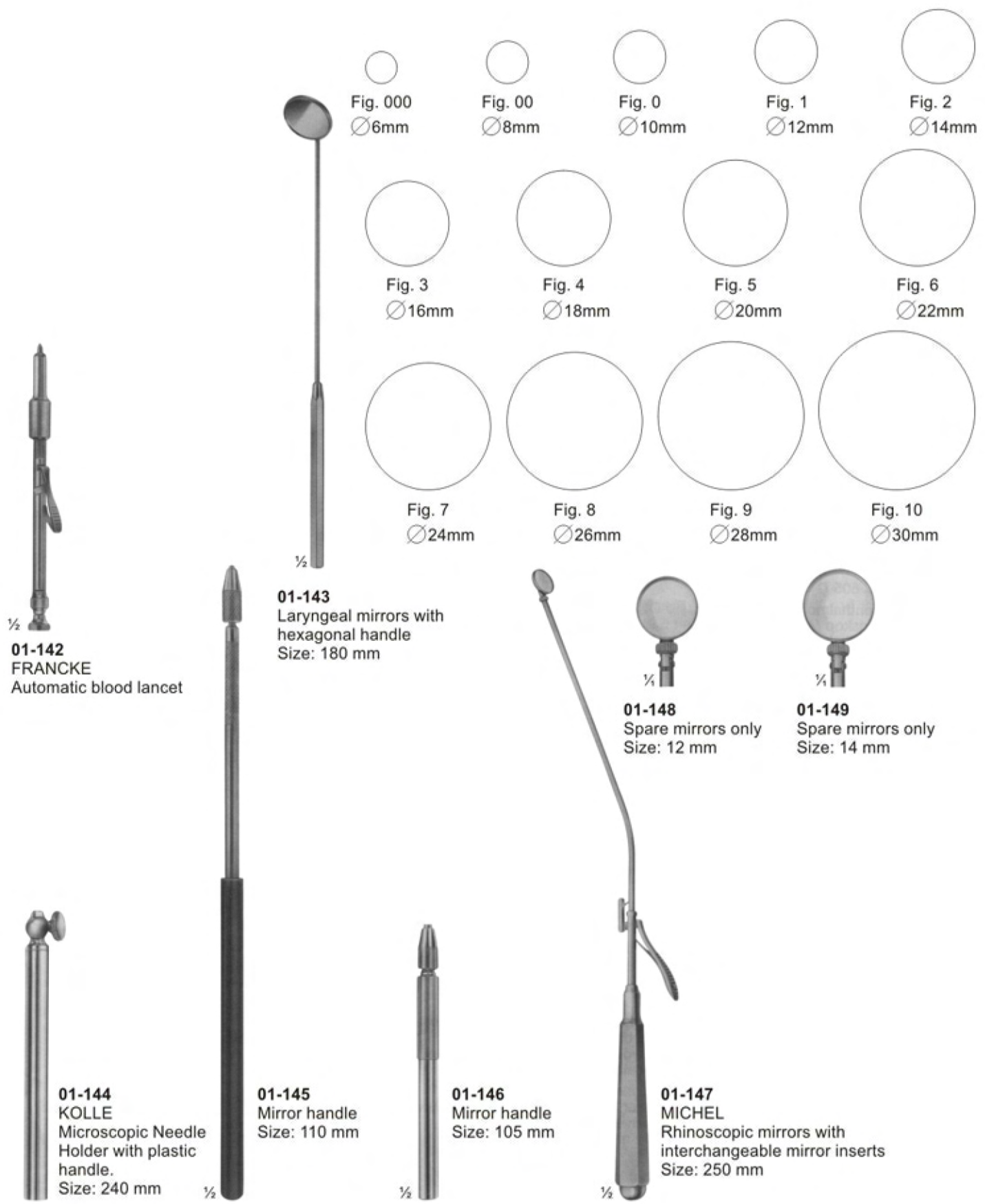

**Fig. 000**  
Ø6mm

**Fig. 00**  
Ø8mm

**Fig. 0**  
Ø10mm

**Fig. 1**  
Ø12mm

**Fig. 2**  
Ø14mm

**Fig. 3**  
Ø16mm

**Fig. 4**  
Ø18mm

**Fig. 5**  
Ø20mm

**Fig. 6**  
Ø22mm

**Fig. 7**  
Ø24mm

**Fig. 8**  
Ø26mm

**Fig. 9**  
Ø28mm

**Fig. 10**  
Ø30mm

**01-142**  
FRANCKE  
Automatic blood lancet

**01-143**  
Laryngeal mirrors with hexagonal handle  
Size: 180 mm

**01-144**  
KOLLE  
Microscopic Needle Holder with plastic handle.  
Size: 240 mm

**01-145**  
Mirror handle  
Size: 110 mm

**01-146**  
Mirror handle  
Size: 105 mm

**01-147**  
MICHEL  
Rhinoscopic mirrors with interchangeable mirror inserts  
Size: 250 mm

**01-148**  
Spare mirrors only  
Size: 12 mm

**01-149**  
Spare mirrors only  
Size: 14 mm

## Laryngoscope and Diagnostic Sets



1/4  
**01-150**  
Infants  
Size: 150 mm

1/4  
**01-151**  
Children  
Size: 200 mm

1/4  
**01-152**  
Adults  
Size: 250 mm

**01-154**



**01-150 - 152**  
MAGILL



1/2  
**01-153**  
Medium battery handle  
only, 25 mm diam.



**01-153-A**  
Spare bulb  
2.7 volt, for  
otoscopes



**01-153-B**  
Spare bulb  
2.6 volt, for  
ophthalmoscopes



**01-155**



**01-156**  
Otoscope set, consists of  
battery handle without batteries,  
3 ear specula, 1 bulb in valvet lined case



**01-157**  
Diagnostic set, otoscope with three specula,  
nasal speculam, lamp holder, two laryngeal  
mirrors, tongue blade holder



# Laryngoscopes



**01-158**  
**MILLER**  
Laryngoscope set, consists of battery handle ( without battery )  
with four miller laryngoscope blades

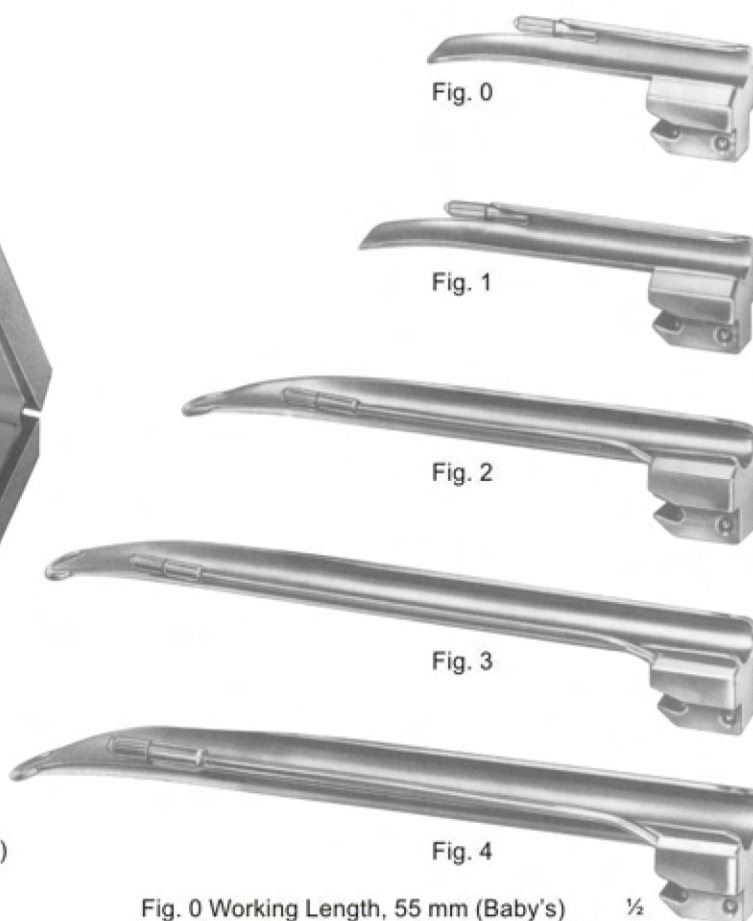

Fig. 0 Working Length, 55 mm (Baby's)  $\frac{1}{2}$   
Fig. 1 Working Length, 80 mm (Children's)  
Fig. 2 Working Length, 130 mm (Adolescent's)  
Fig. 3 Working Length, 170 mm (Women's)  
Fig. 4 Working Length, 180 mm (Men's)



**01-159**  
**GUEDEL-NEGUS**  
Laryngoscope set, consists of battery handle ( without battery )  
with four miller laryngoscope blades

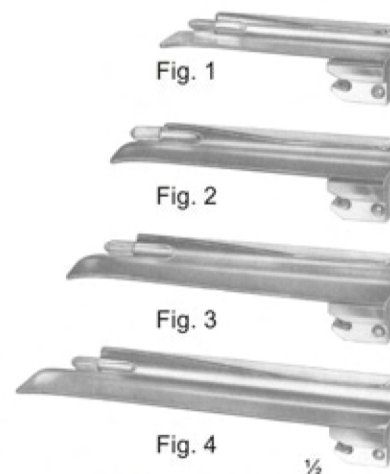

Fig. 1 Working Length, 70 mm (Children's)  
Fig. 2 Working Length, 90 mm (Adolescent's)  
Fig. 3 Working Length, 110 mm (Women's)  
Fig. 4 Working Length, 135 mm (Men's)

# Laryngoscopes



**01-160**  
**McINTOSH**  
 Laryngoscope Set, Consists Of Battery Handle ( Without Battery )  
 With Three McIntosh Blades, Fig. 1, Fig. 2, Fig. 3

**01-161**  
**McINTOSH**  
 Laryngoscope Set, Consists Of Battery Handle ( Without Battery )  
 With Five McIntosh Blades, Fig. 0, Fig. 1, Fig. 2, Fig. 3, Fig. 4

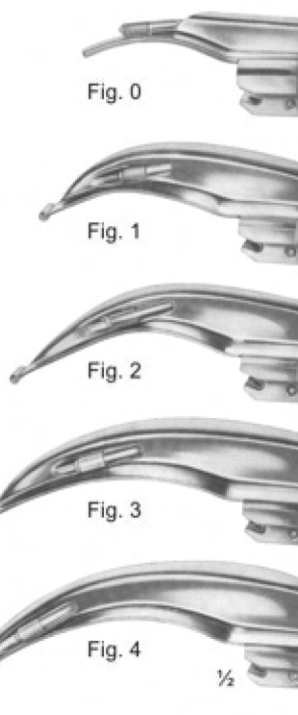

01-161 A Fig. 0 Working Length, 55 mm (Baby's)  
 01-161 B Fig. 1 Working Length, 75 mm (Children's)  
 01-161 C Fig. 2 Working Length, 90 mm (Adolescent's)  
 01-161 D Fig. 3 Working Length, 110 mm (Women's)  
 01-161 E Fig. 4 Working Length, 135 mm (Men's)

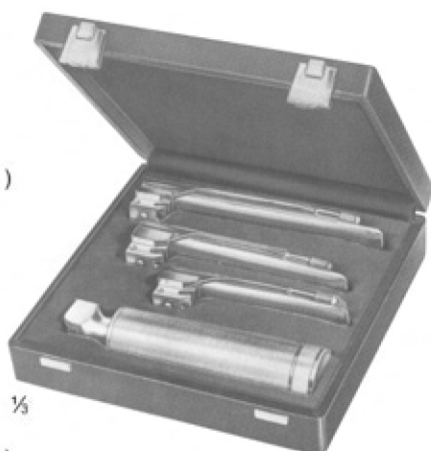

**01-162**  
**FOREGGER**  
 Laryngoscope Set, Consists Of Battery Handle ( Without Battery )  
 With Three Foregger Blades, Fig. 1, Fig. 2, Fig. 3,

**01-163**  
**FOREGGER**  
 Laryngoscope Set, Consists Of Battery Handle ( Without Battery )  
 With Four Foregger Blades, Fig. 1, Fig. 2, Fig. 3, Fig. 4,

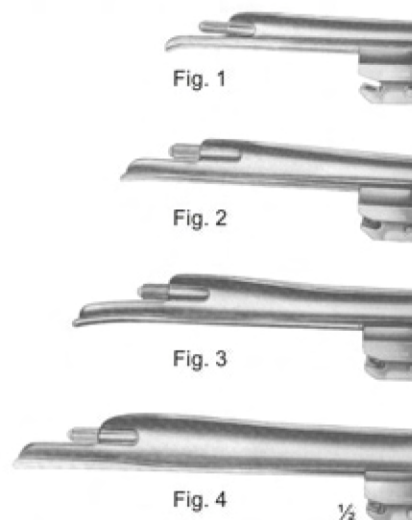

01-162 A Fig. 1 Working Length, 70 mm (Children's)  
 01-162 B Fig. 2 Working Length, 90 mm (Adolescent's)  
 01-162 C Fig. 3 Working Length, 110 mm (Women's)  
 01-162 D Fig. 4 Working Length, 135 mm (Men's)



**01-164**  
 Fiber Optic Battery Handle  
 30mm diam.



**01-165**  
 Fiber Optic Battery Handle  
 18mm diam.



**01-166**  
 Replacement Lamp  
 ( Krypton ) 2.5 V



**01-167**  
 Replacement Lamp  
 ( Halogen ) 2.5 V

## Examination & Measuring Instruments

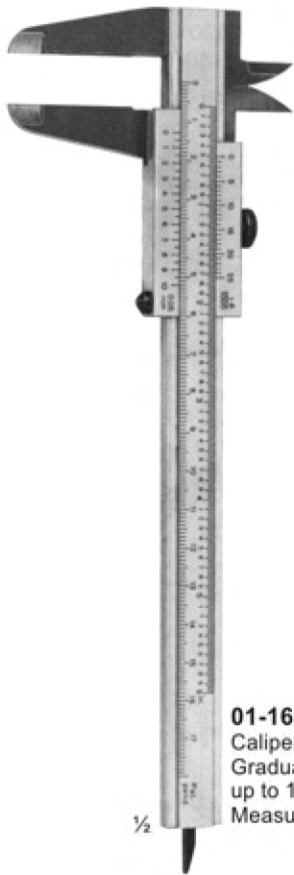

**01-168**  
Caliper Of Aluminium  
Graduated in mm & inches  
up to 180mm  
Measuring Range up to 139mm



**01-169**  
VERNIER  
Universal Caliper Of Steel  
Graduated in mm & inches  
up to 180mm  
Measuring Range up to 120mm  
with Vernier in 1/10mm & 1/16"

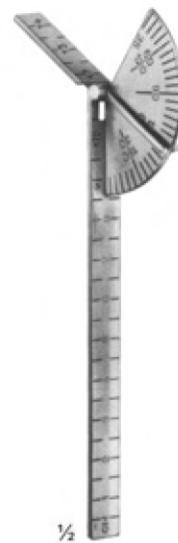

**01-170**  
CARROLL  
Size: 145 mm  
Finger Goniometer



**01-171**  
TOWNLEY  
Graduated in  
mm & inches  
Size: 115 mm



**01-172**  
COLLIN  
Druck Pressure 72 kg  
Size: 125 mm



**01-173**  
BERTILLON  
Caliper For Measuring The Head  
Size: 320 mm



**01-174**  
CASTROVIEJO  
Caliper  
Size: 75mm



**01-175**  
MOLTGEN  
Goniometer



**01-176**  
Size: 150 mm



**01-177**  
Size: 500 mm





# Dissecting Knives



1/4  
**02-101 - 110**  
Fig. 1 - 10



**02-101**  
Fig. 1  
30 mm



**02-102**  
Fig. 2  
36 mm



**02-103**  
Fig. 3  
40 mm



**02-104**  
Fig. 4  
45 mm



**02-105**  
Fig. 5  
50 mm



1/4  
**02-106**  
Fig. 6  
27 mm



**02-107**  
Fig. 7  
35 mm



**02-108**  
Fig. 8  
40 mm



**02-109**  
Fig. 9  
47 mm



**02-110**  
Fig. 10  
50 mm

# Amputating Knives, Cartilage Knives and Autopsy Knives

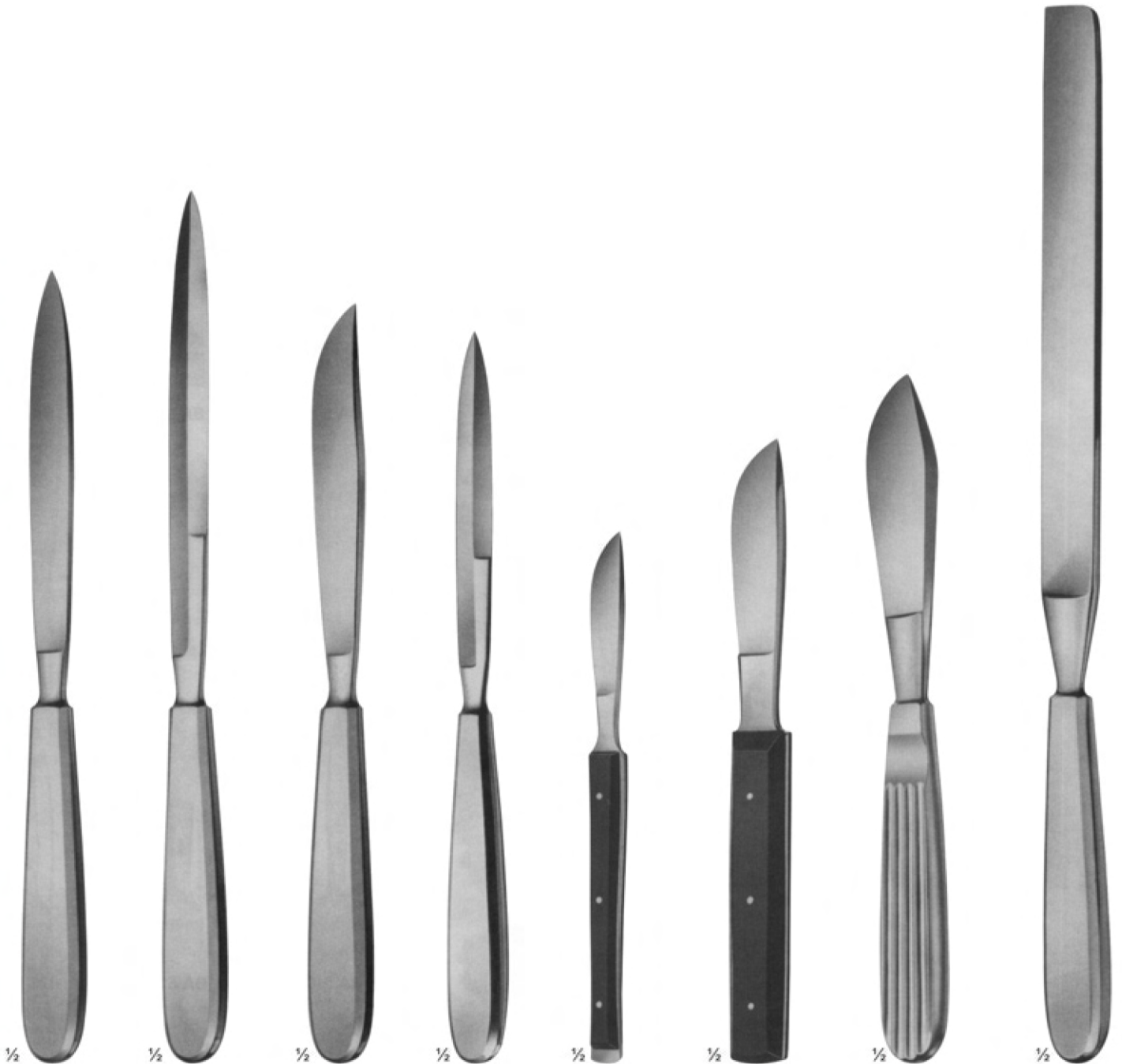

LISTON 02-111 Size: 130 mm	02-115 CATLIN Size: 160 mm	02-116 LANGENBECK Size: 120 mm	02-117 Size: 110 mm	02-118 Size: 55 mm	02-119 Size: 70 mm	02-120 Size: 80 mm	02-121 Size: 195 mm
Blade length	Blade length	Blade length	Blade length	Blade length	Blade length	Blade length	Blade length
02-112 Size: 160 mm	Amputating Knives	Flap Knives	Interosseous Knives	with raspatory, Wooden handle	Wooden handle	Metal handle	Metal handle
02-113 Size: 190 mm							
02-114 Size: 200 mm							

Blade length  
Amputating Knives

# Cone Knives, Myomatome, Trigeminal and Tonsil Knives



**02-122**  
AYRE  
Size: 235 mm  
Cone Knife

**02-123**  
Size: 230 mm  
Cone Knife

**02-124**  
SEGOND  
Size: 270 mm  
Myomatome

**02-125**  
OLIVECRONA  
Size: 205 mm  
Trigeminal  
Knife

**02-126**  
Size: 230 mm  
Trigeminal  
Knife

**02-127**  
FOWLER  
Size: 200 mm  
Tonsil Knife

**02-128**  
ABRAHAM  
Size: 215 mm  
Tonsil Knife

**02-129**  
BRUNINGS  
Size: 215 mm  
Tonsil Knife



## Scalpel Handles



02-130  
STANDARD  
No. 3  
Solid  
12 cm

02-131  
No. 3  
Solid  
12 cm

02-132  
No. 3  
Solid  
12 cm

02-133  
No. 3 L  
Straight  
Solid  
21.5 cm

02-134  
No. 3 L  
Angled  
Solid  
21 cm

02-135  
No. 7  
Solid  
16 cm

02-136  
No. 7 K  
Solid  
12.5 cm

02-137  
Hollow-Round  
15.5 cm

02-138  
No. 3  
Straight  
Solid,  
Round  
14.5 cm

02-139  
No. 3  
Angled  
Solid,  
Round  
14 cm

## Micro Scissors (Spring Type) with Flat Handles

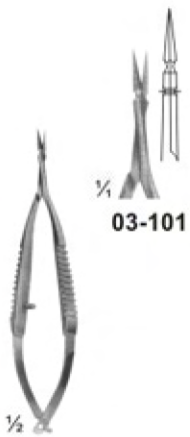

**03-101 - 103**  
VANNAS  
Size: 85 mm



**03-104 - 105**  
CASTROVIEJO  
Size: 95 mm

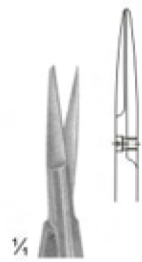
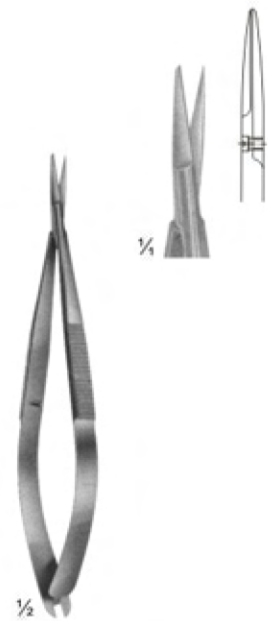

**03-106**  
NOYES  
Size: 125 mm

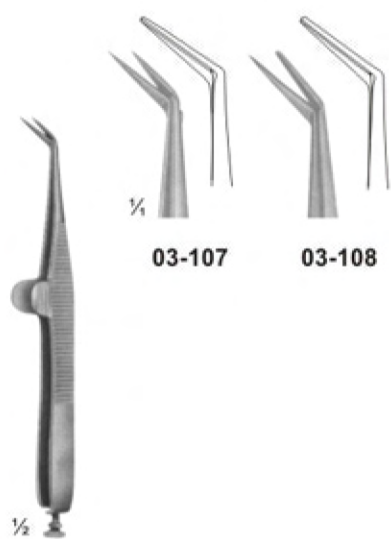

**03-107 - 108**  
WECKER  
Eye scissor  
Size: 110 mm

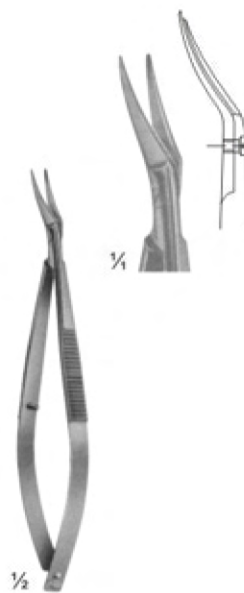

**03-109**  
CASTROVIEJO  
Eye scissor  
Size: 115 mm

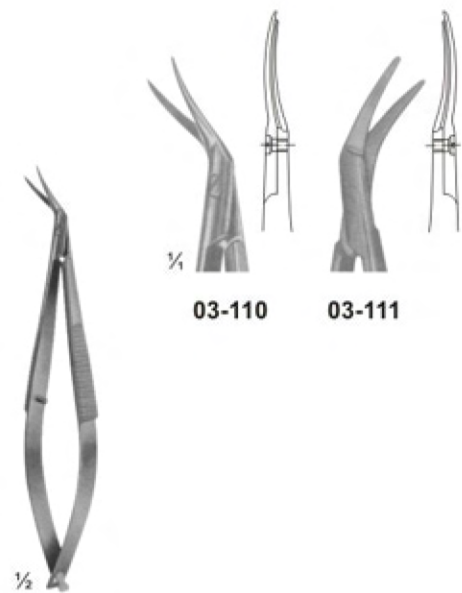

**03-110 - 111**  
CASTROVIEJO  
Eye scissor  
Size: 110 mm

## Micro Scissors (Spring Type) with Flat Handles

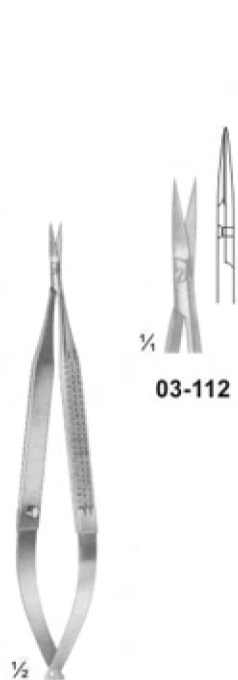

03-112



03-113



03-114  
BIEMER  
Vein scissor  
Size: 130 mm



03-115  
Size: 160 mm



03-116 - 117  
VANNAS  
Size: 160 mm



03-116



03-117

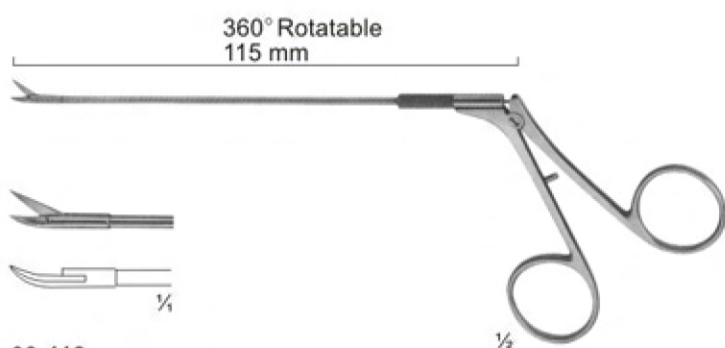

03-118  
CASPAR  
Micro scissor curved  
Size: 115 mm



03-119



03-120



03-121



03-119 - 121  
Micro dissecting scissor  
Size: 145 mm



## Micro Scissors (Spring Type) bayonet-Shaped



**03-122**  
YASARGIL  
Size: 245 mm



**03-123**  
45°



**03-124**  
45°



**03-123 - 124**  
laterally angled  
Size: 200 mm



**125°**



**03-125**  
laterally angled  
Size: 190 mm

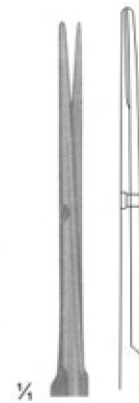

**03-126**

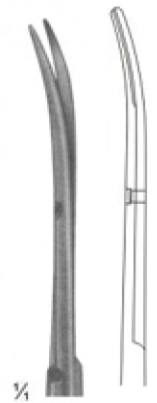

**03-127**



**03-126 - 127**  
YASARGIL  
Size: 225 mm

## Delicate Scissors

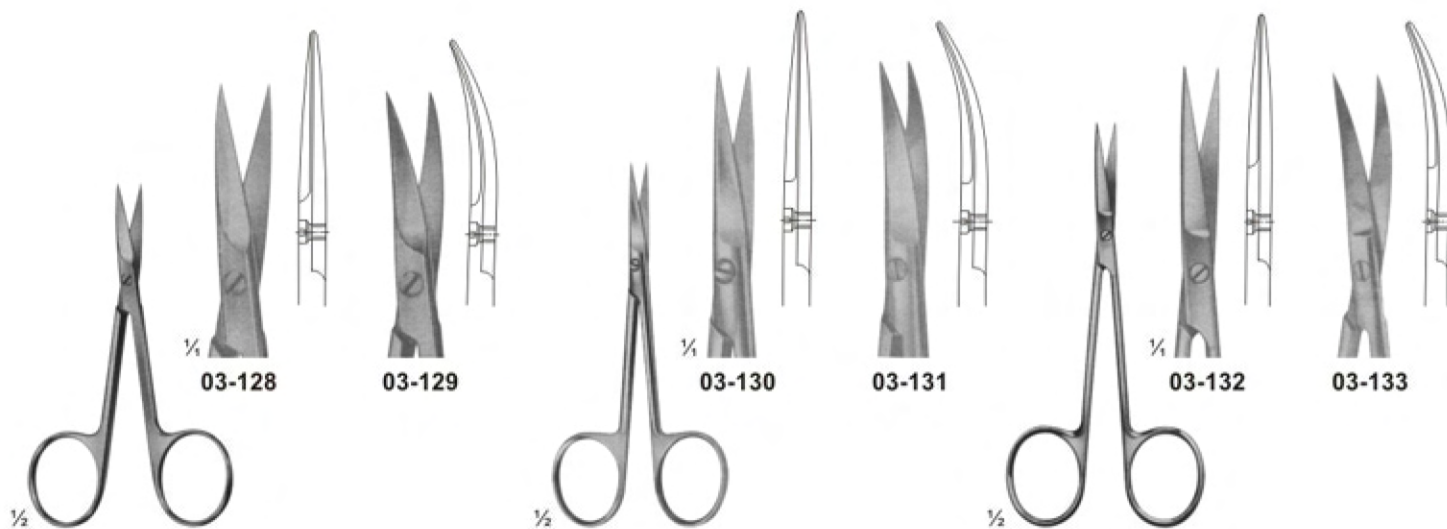

**03-128 - 129**  
Size: 90 mm

**03-130 - 131**  
Size: 95 mm

**03-132 - 133**  
Size: 105 mm



**03-134 - 135**  
Size: 120 mm

**03-136 - 137**  
Size: 115 mm

## Delicate Scissors



**03-138 - 140**  
Size: 120 mm



**03-138**



**03-139**



**03-140**



**03-141 - 144**  
Size: 130 mm

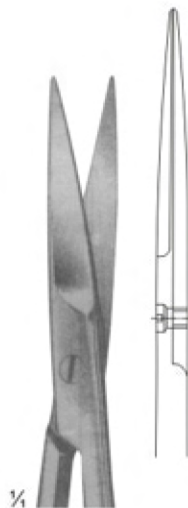

**03-141**

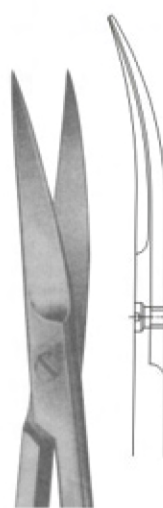

**03-142**



**03-143**



**03-144**





# Surgical Scissors

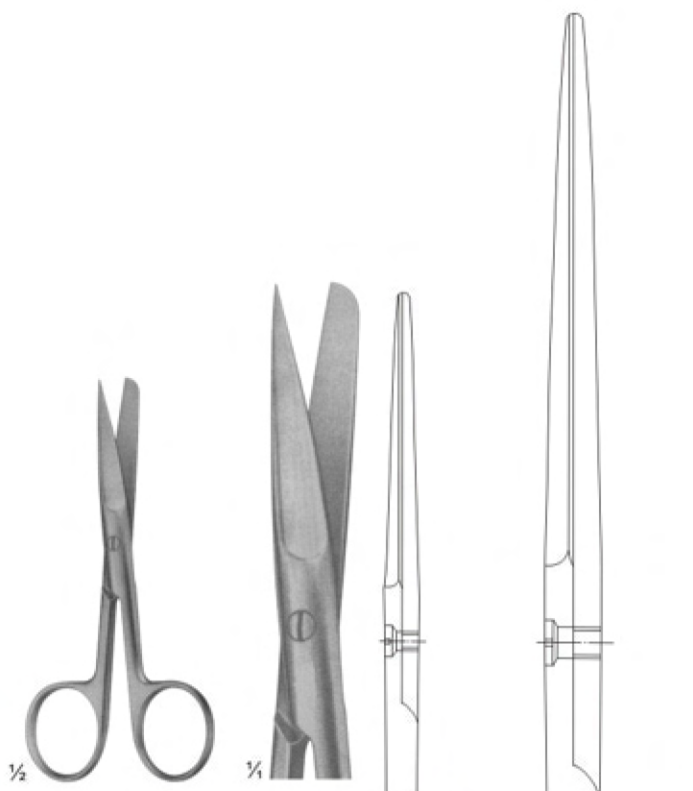

**03-145 - 153 (Standard types)**  
**03-145** ( 105 mm )  
**03-146** ( 115 mm )  
**03-147** ( 130 mm )  
**03-148** ( 145 mm )  
**03-149** ( 150 mm )  
**03-150** ( 165 mm )  
**03-151** ( 175 mm )  
**03-152** ( 185 mm )  
**03-153** ( 200 mm )

**03-145**  
Size: 105 mm

**03-153**  
Size: 200 mm



**03-154 - 160 (Standard types)**  
**03-154** ( 115 mm )  
**03-155** ( 130 mm )  
**03-156** ( 145 mm )  
**03-157** ( 150 mm )  
**03-158** ( 165 mm )  
**03-159** ( 175 mm )  
**03-160** ( 185 mm )

**03-154**  
Size: 115 mm

**03-160**  
Size: 185 mm

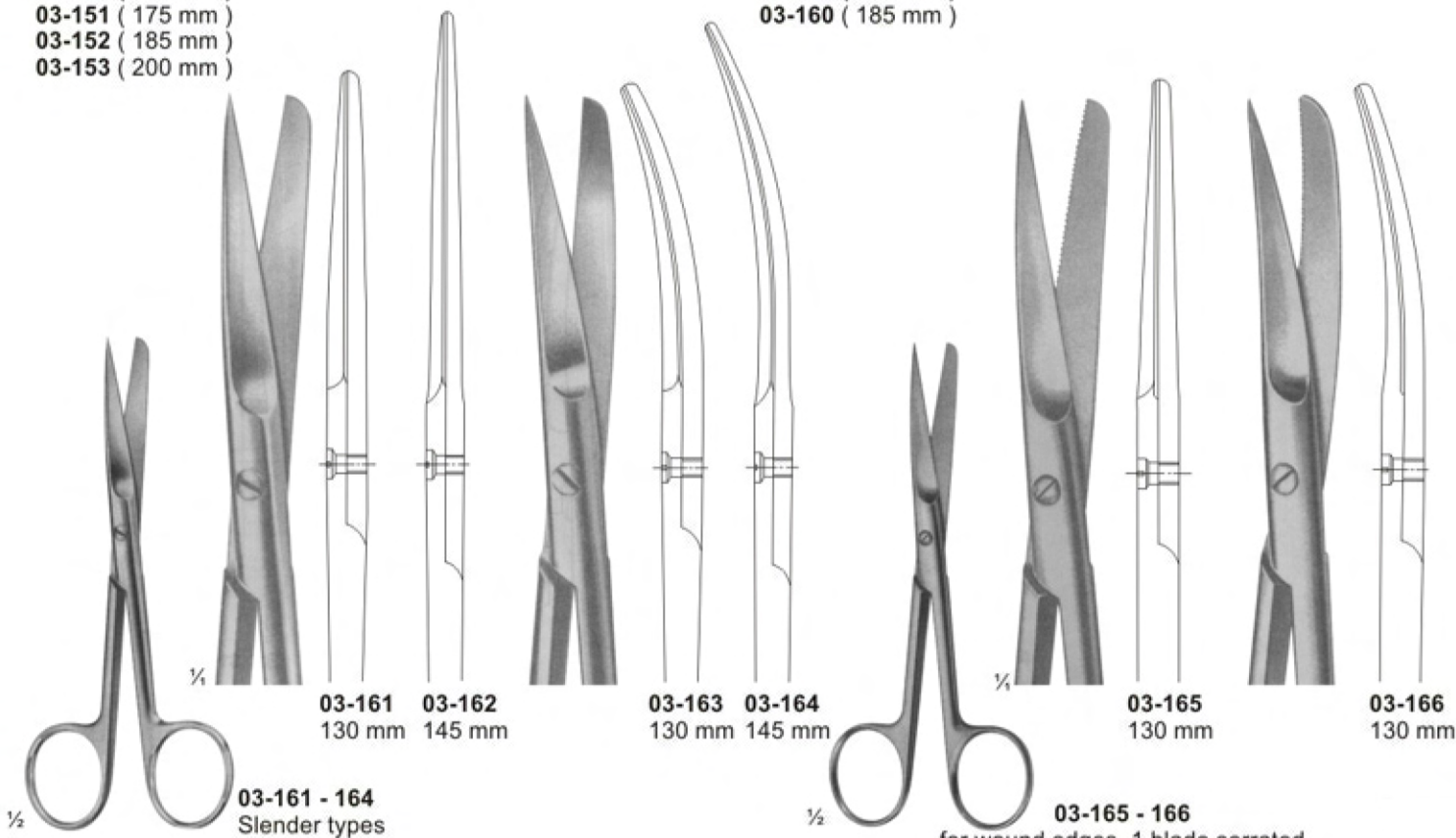

**03-161** 130 mm  
**03-162** 145 mm

**03-163** 130 mm  
**03-164** 145 mm

**03-165** 130 mm

**03-166** 130 mm

**03-161 - 164**  
Slender types

**03-165 - 166**  
for wound edges. 1 blade serrated

# Surgical Scissors

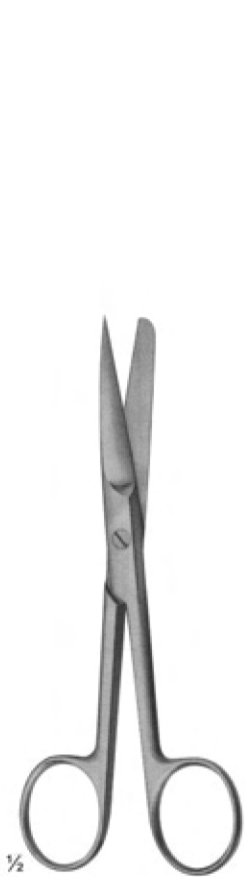

**03-167 - 169**  
DEAVER  
with flat lock

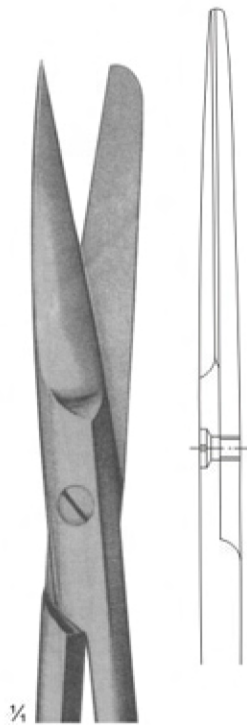

**03-167**  
Size: 145 mm

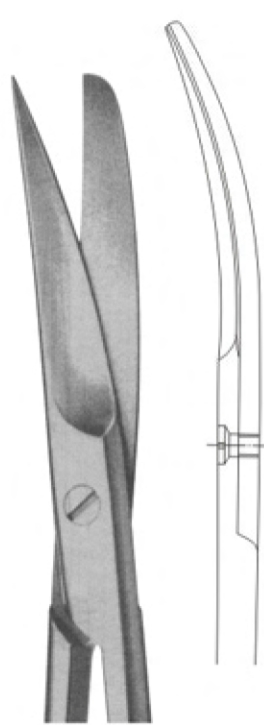

**03-168**  
Size: 145 mm

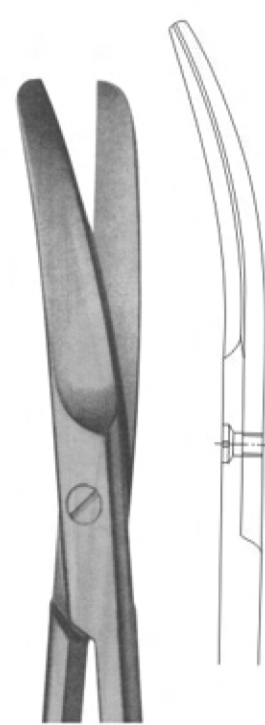

**03-169**  
Size: 145 mm



**03-170 - 172**  
Incision scissors

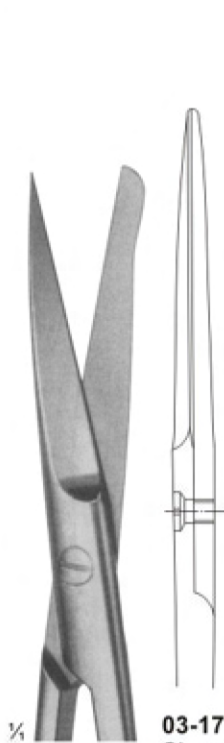

**03-170**  
Size: 130 mm



**03-171**  
Size: 145 mm



**03-172**  
Size: 165 mm

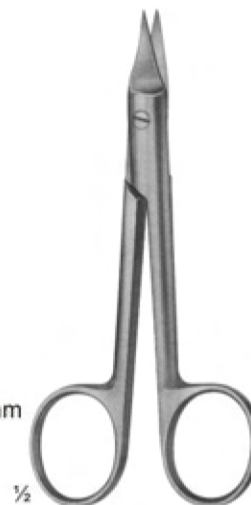

**03-173**  
SYSTRUNK  
Nail splitting scissors

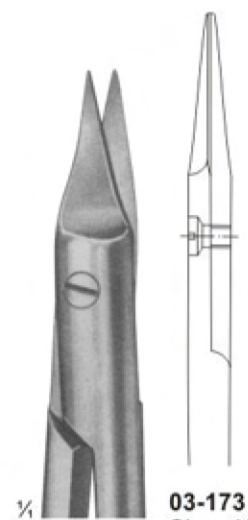

**03-173**  
Size: 130 mm

## Dissecting Scissors

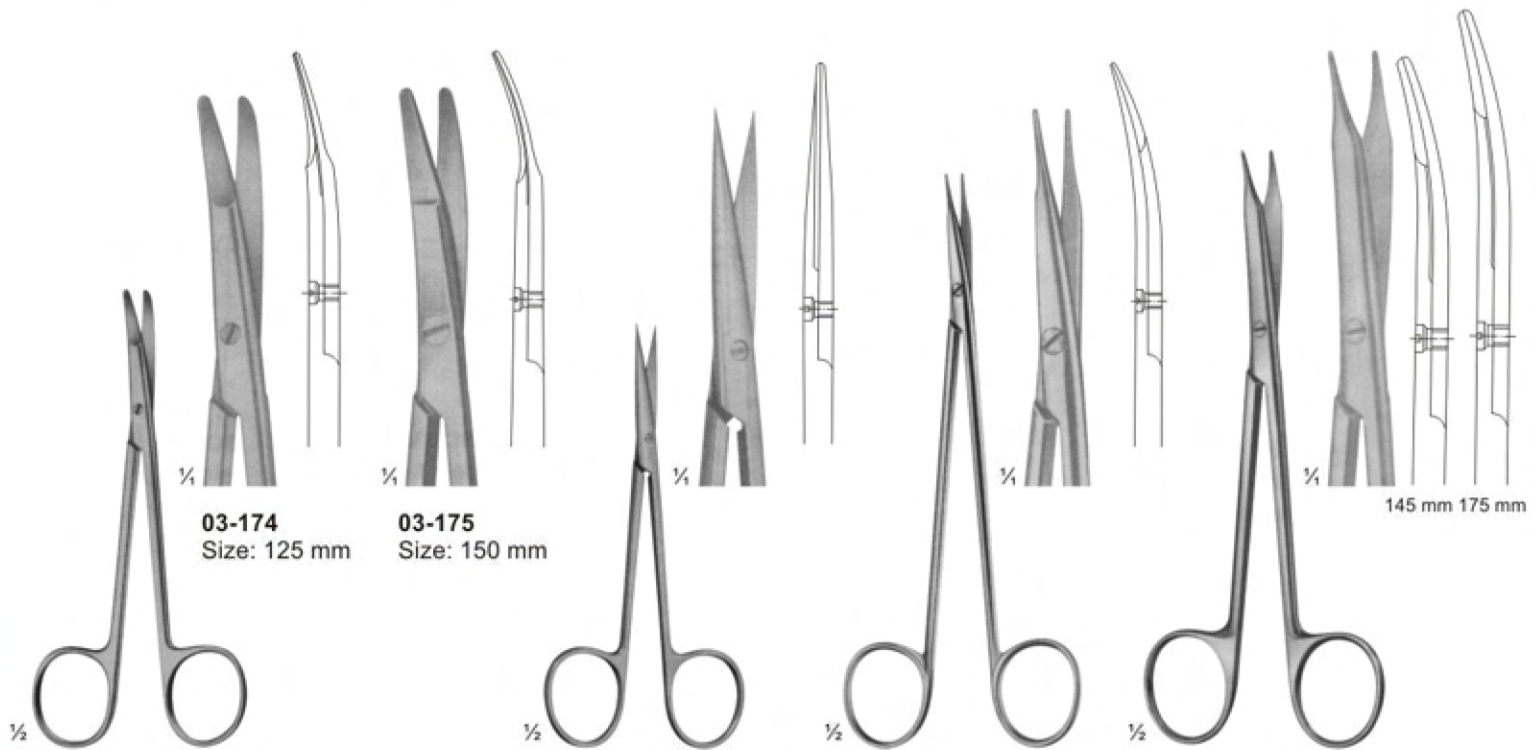

**03-174 - 175**  
KILNER  
Special flat points for dissecting  
and undermining the skin

**03-176**  
KILNER  
Fine dissecting scissors  
Size: 115 mm

**03-177**  
JAMESON  
Dissecting scissors  
Size: 150 mm

**03-178**  
REYNOLDS  
Dissecting scissors  
Size: 145 - 175 mm

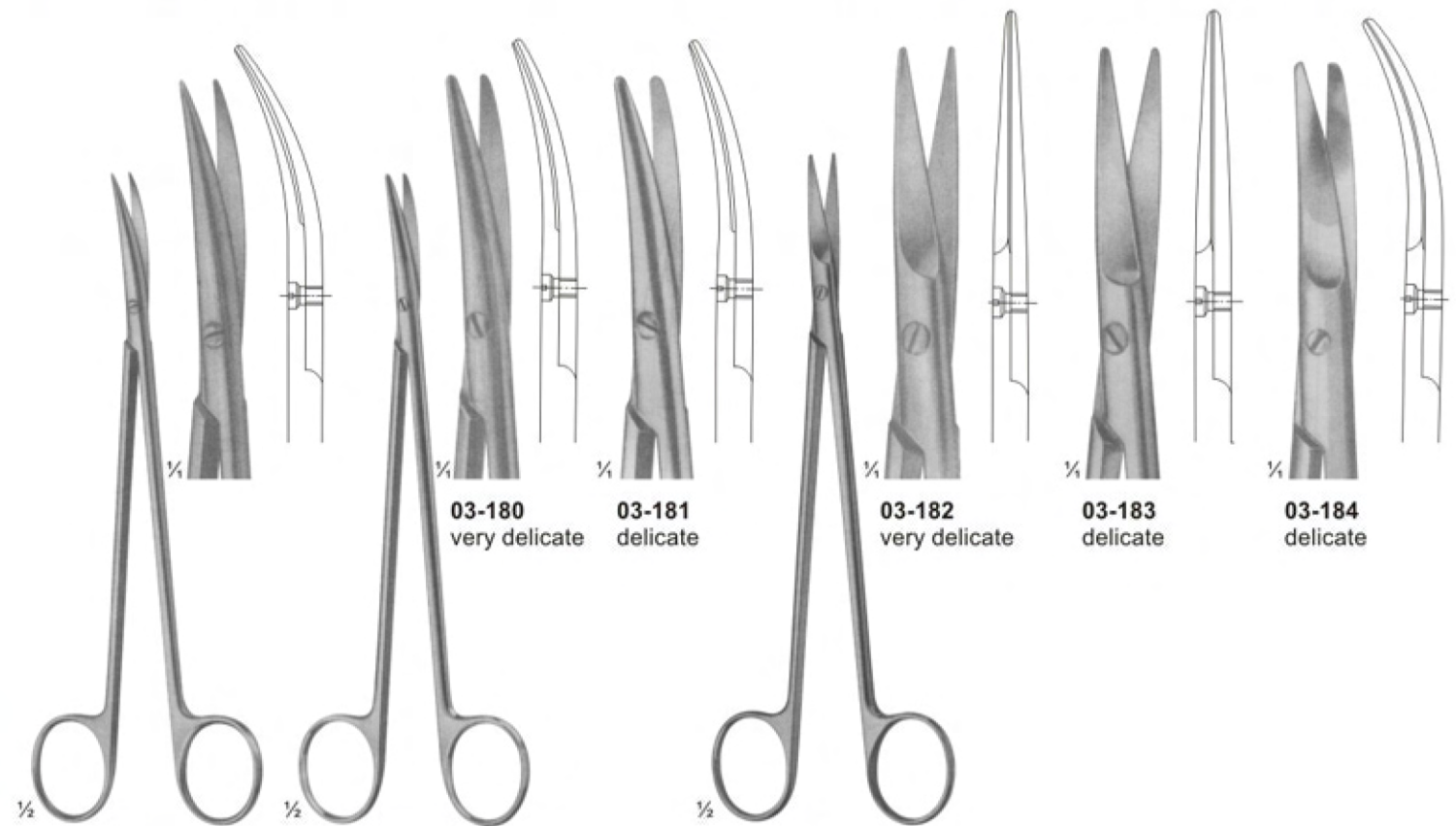

**03-179**  
DE BAKEY  
Arteriotomy scissors  
Size: 175 mm

**03-180 - 181**  
TOENNIS ADSON  
Dissecting scissors  
Size: 175 mm

**03-182 - 184**  
TOENNIS  
Dissecting scissors  
Size: 180 mm



# Dissecting Scissors

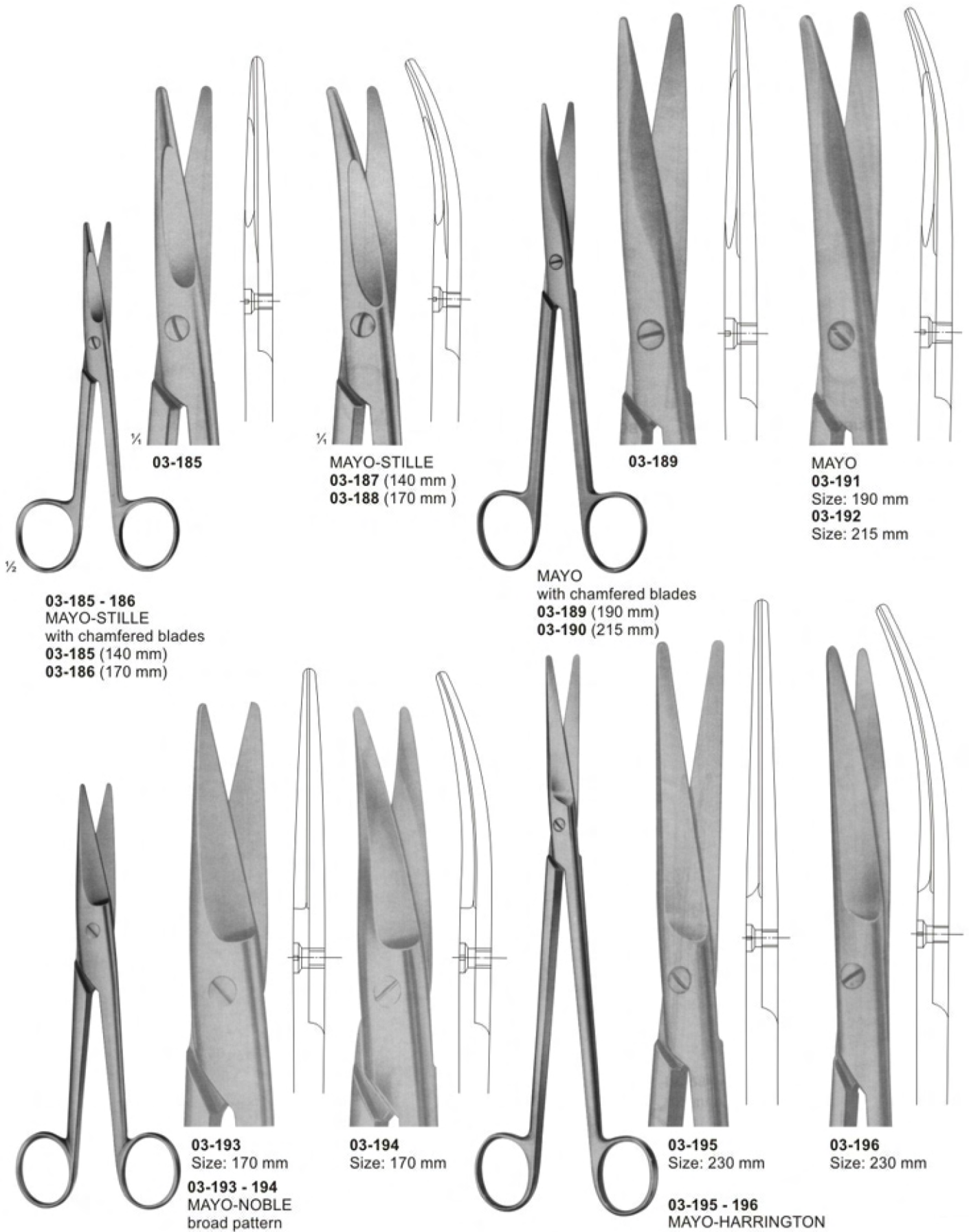

## Scissors for Cardiovascular and Neuro-Surgery

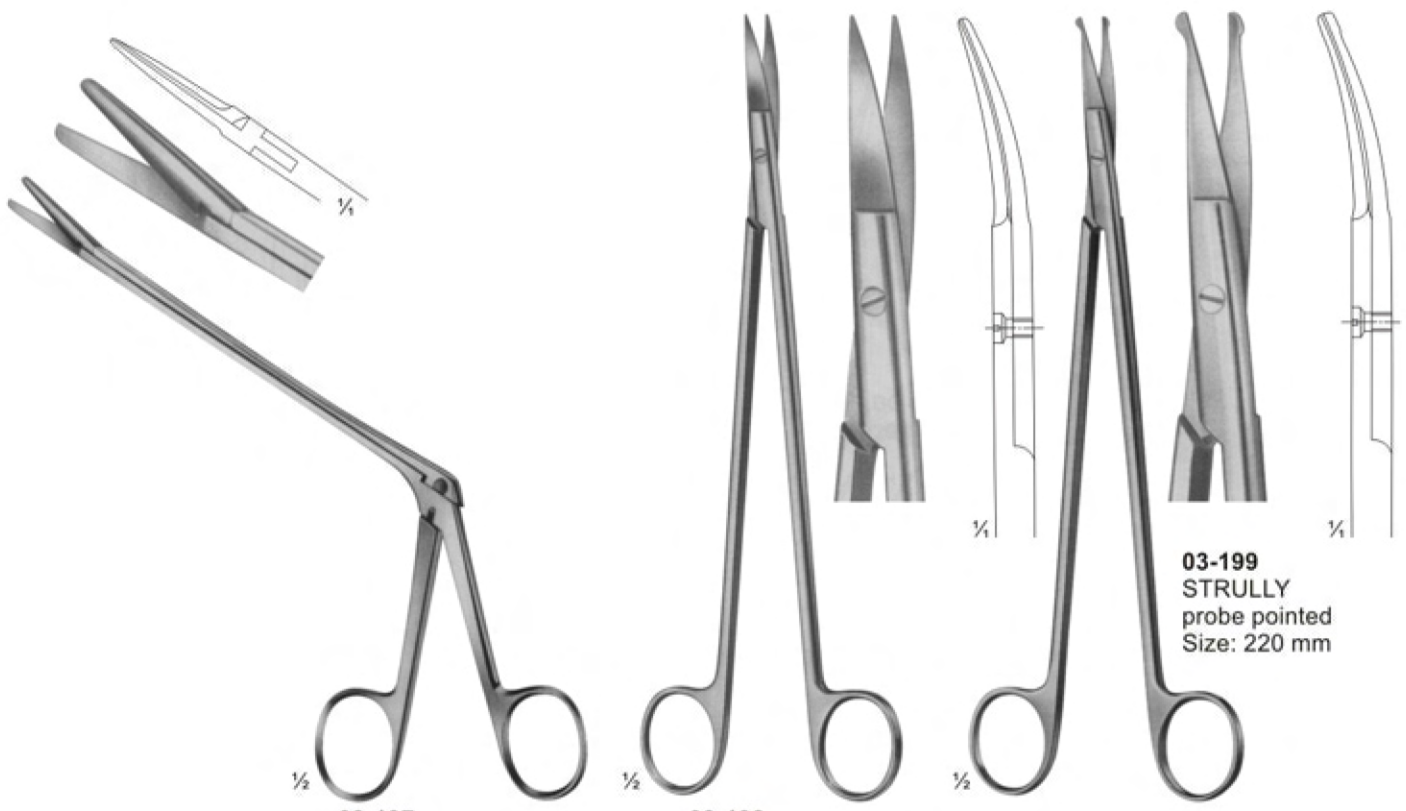

03-197  
OLIVECRONA  
Dura scissors

03-198  
STRULLY  
pointed  
Size: 220 mm

03-199  
STRULLY  
probe pointed  
Size: 220 mm

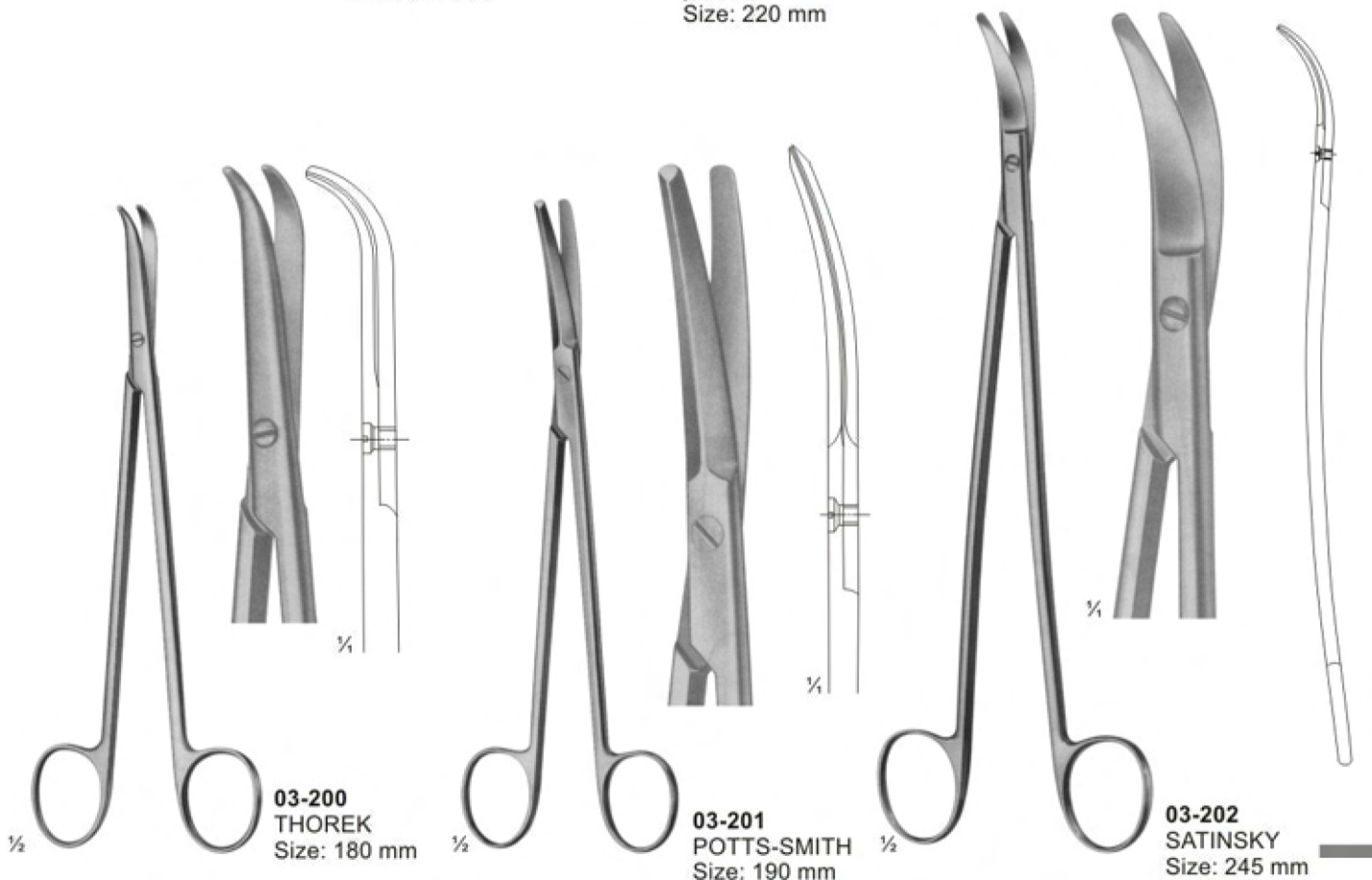

03-200  
THOREK  
Size: 180 mm

03-201  
POTTS-SMITH  
Size: 190 mm

03-202  
SATINSKY  
Size: 245 mm

## Delicate, Nasal and Tonsil Scissors

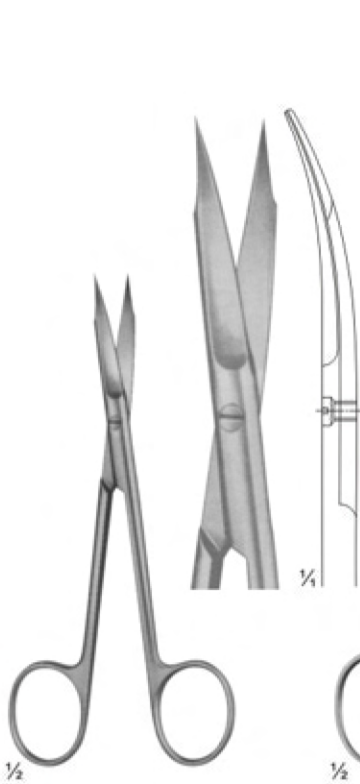

**03-203**  
1 finely toothed blade  
Size: 130 mm

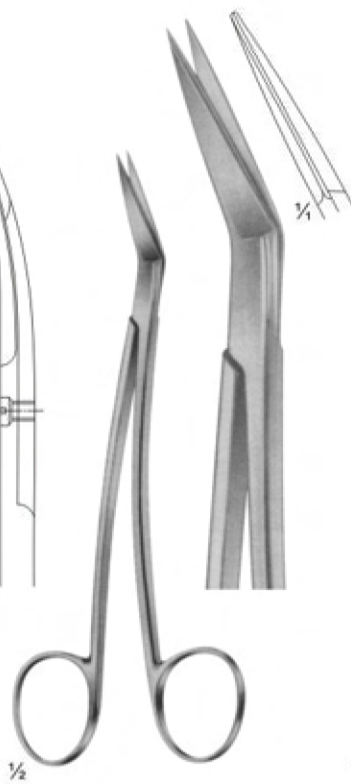

**03-204**  
LOCKLIN  
curved sideways,  
1 toothed blade  
Size: 155 mm

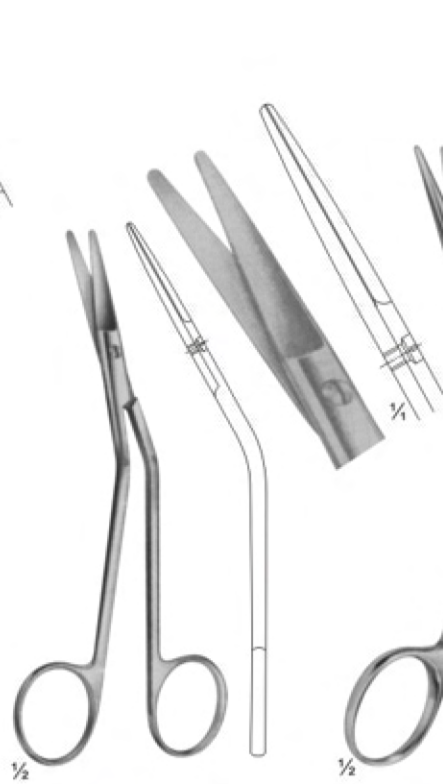

**03-205**  
FOMON  
blades serrated  
Size: 145 mm

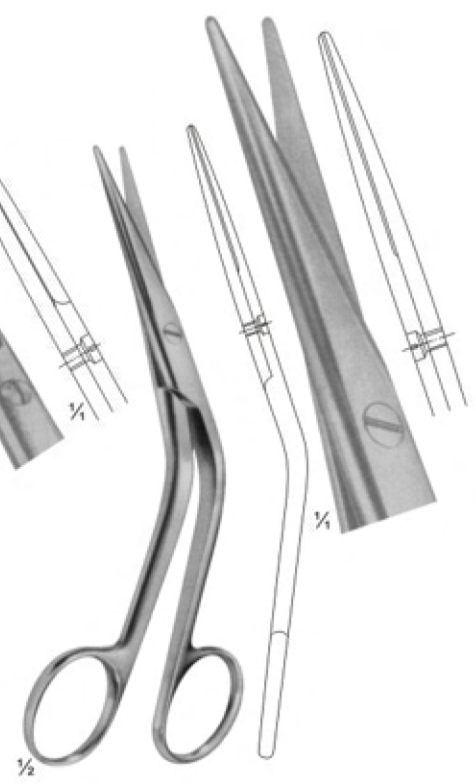

**03-206**  
COTTLE  
Size: 165 mm



**03-207**  
HEYMANN-KNIGHT  
Size: 175 mm

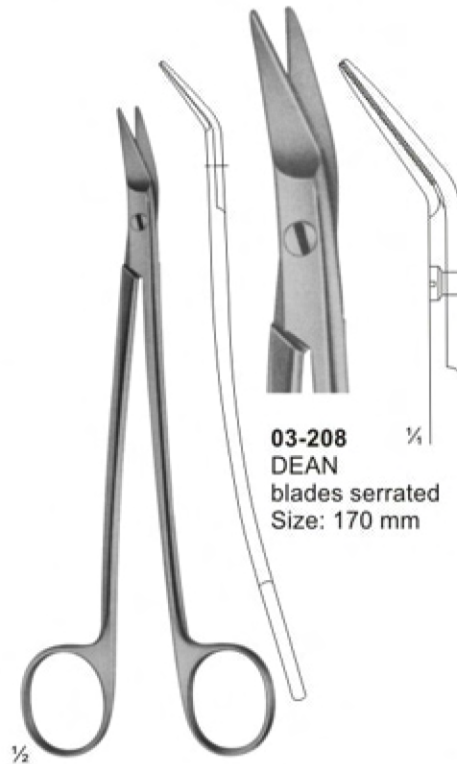

**03-208**  
DEAN  
blades serrated  
Size: 170 mm

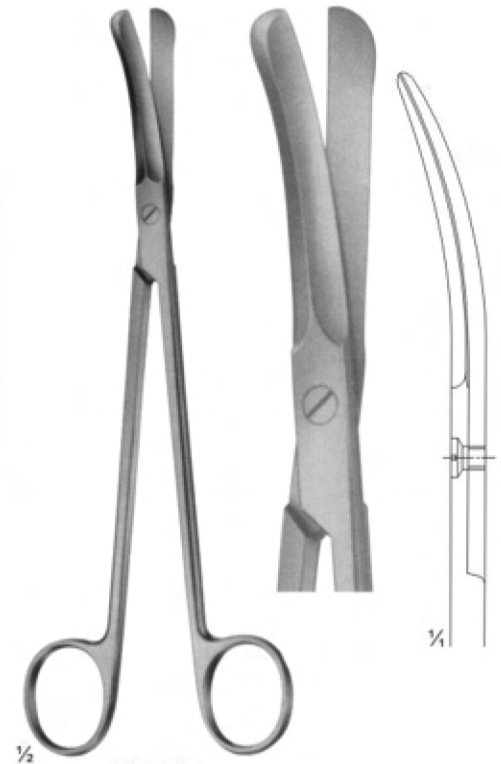

**03-209**  
GOOD  
Size: 195 mm



# Bone Shears

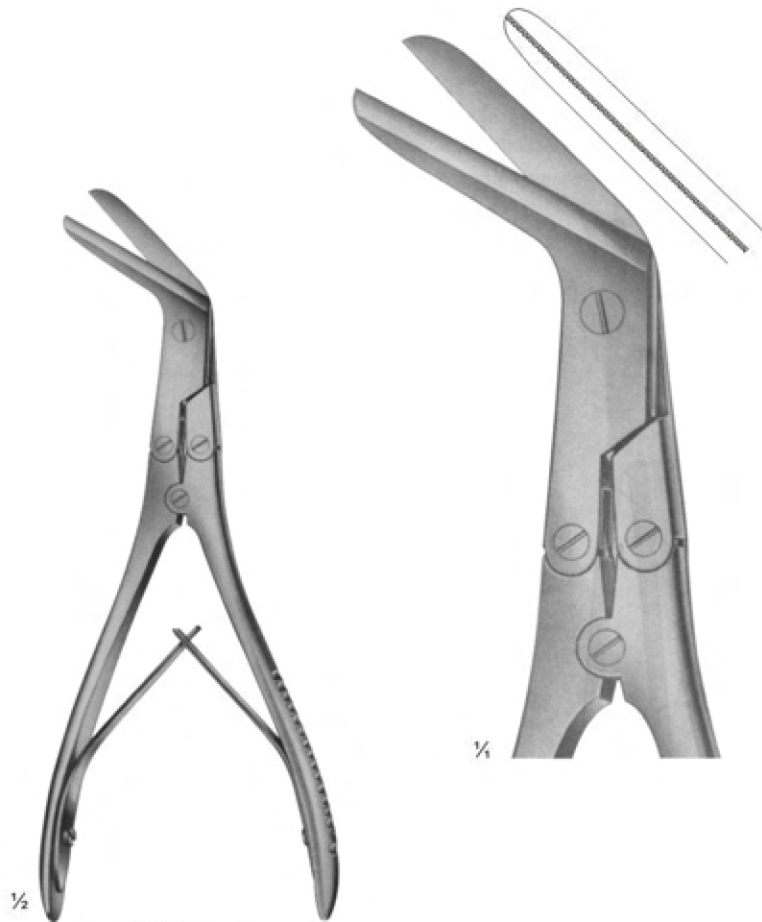

**03-210**  
KILLIAN  
Size: 200 mm



**03-211 - 03-212**

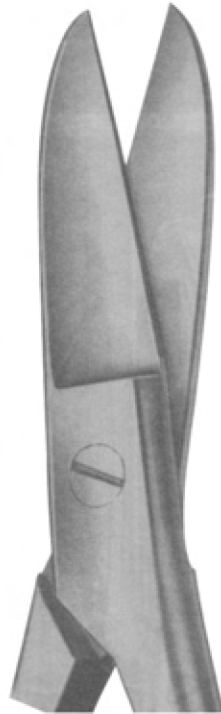

**03-211**  
195 mm

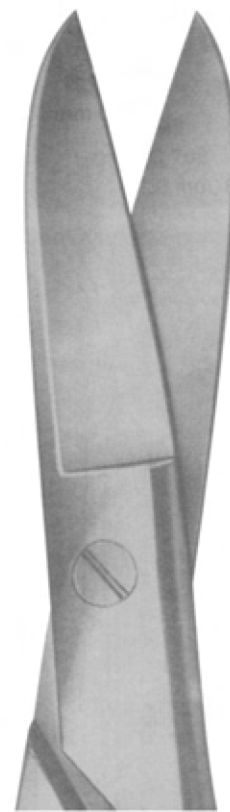
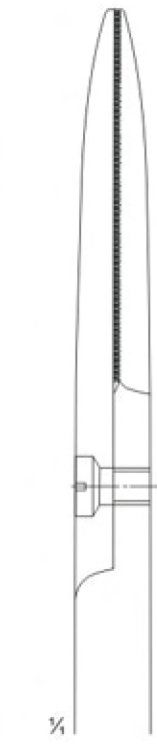

**03-212**  
225 mm



# Scissors for deep operations and for Gynaecology

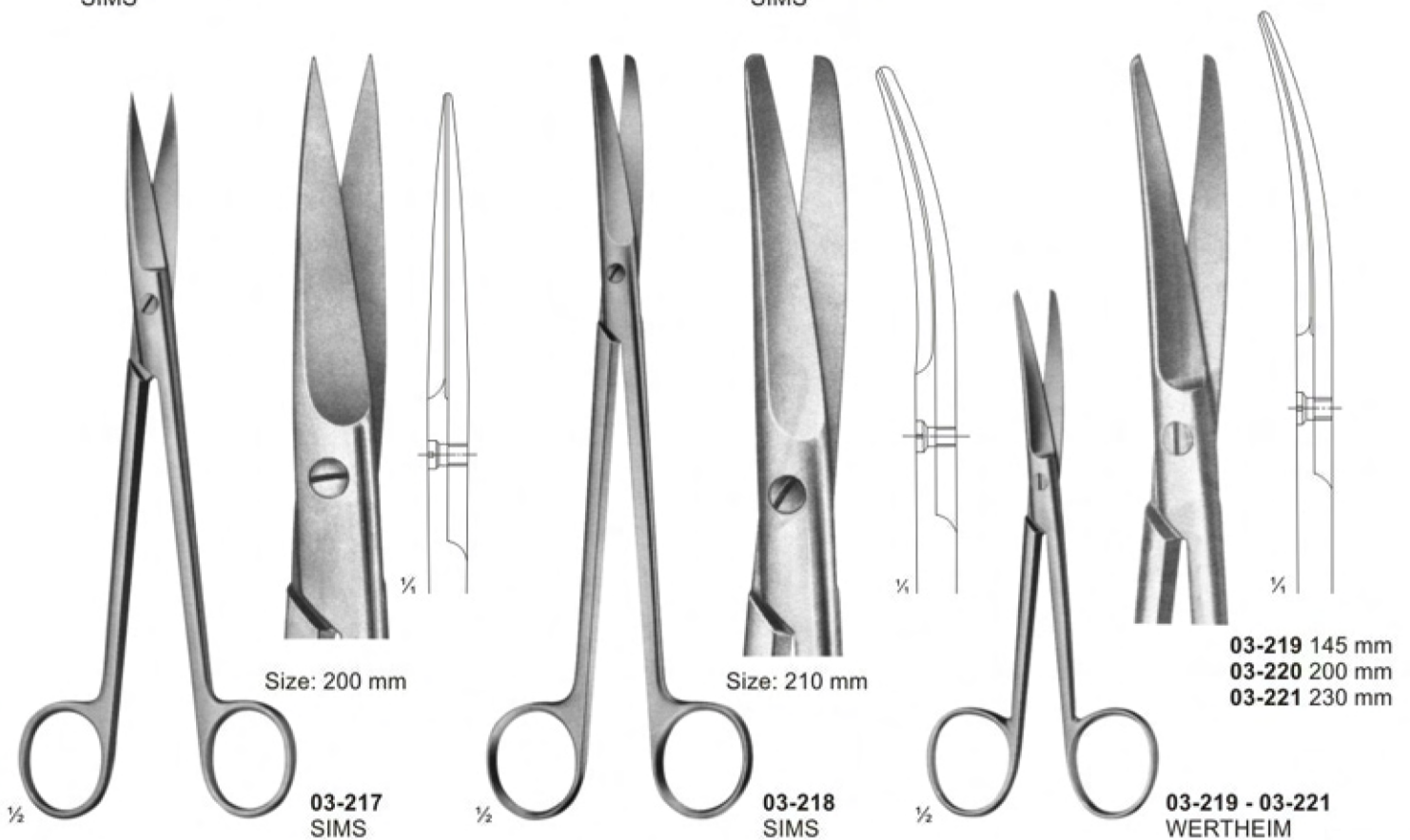
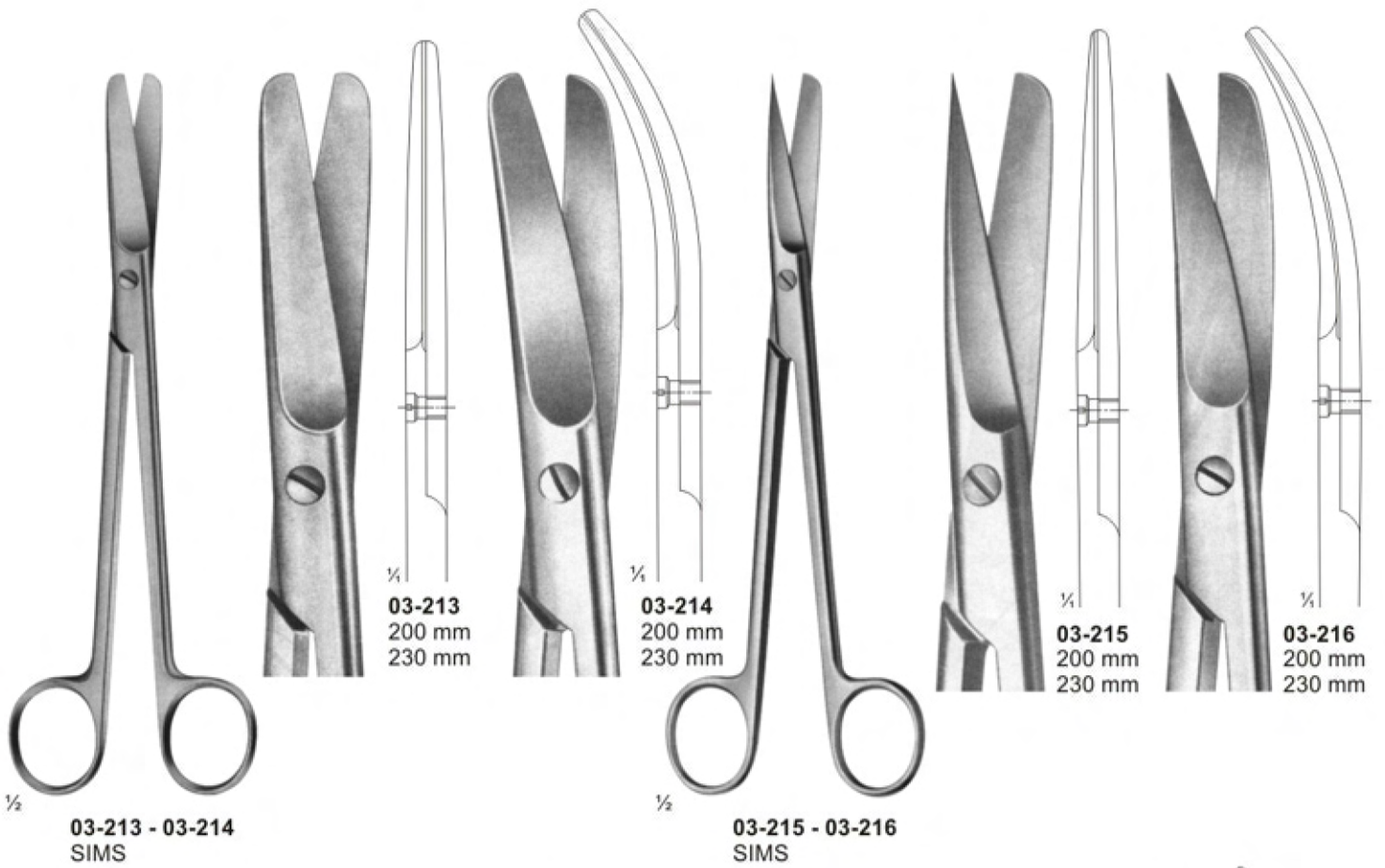

# Scissors for Obstetrics

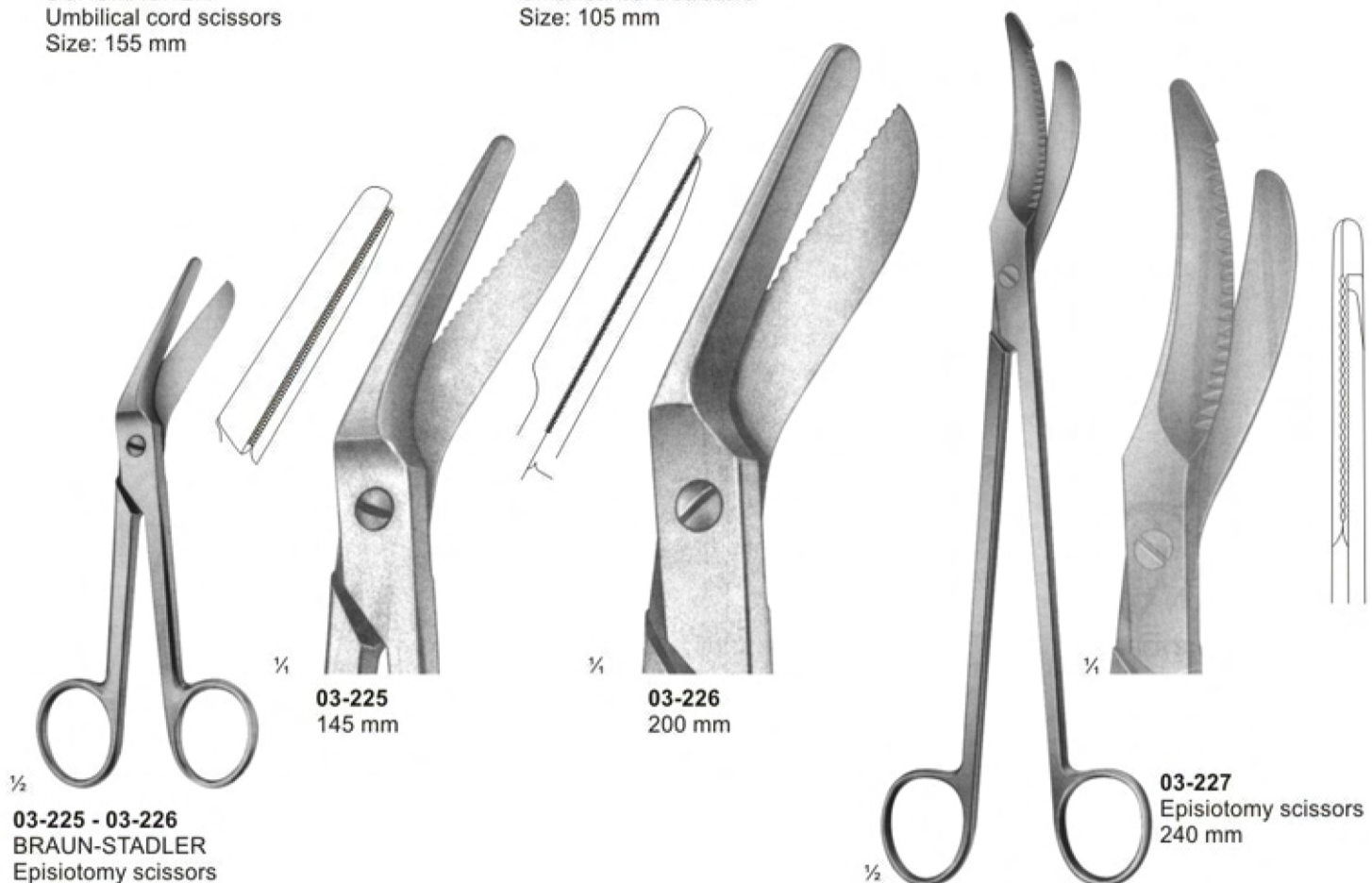



# Wire and Plate Scissors

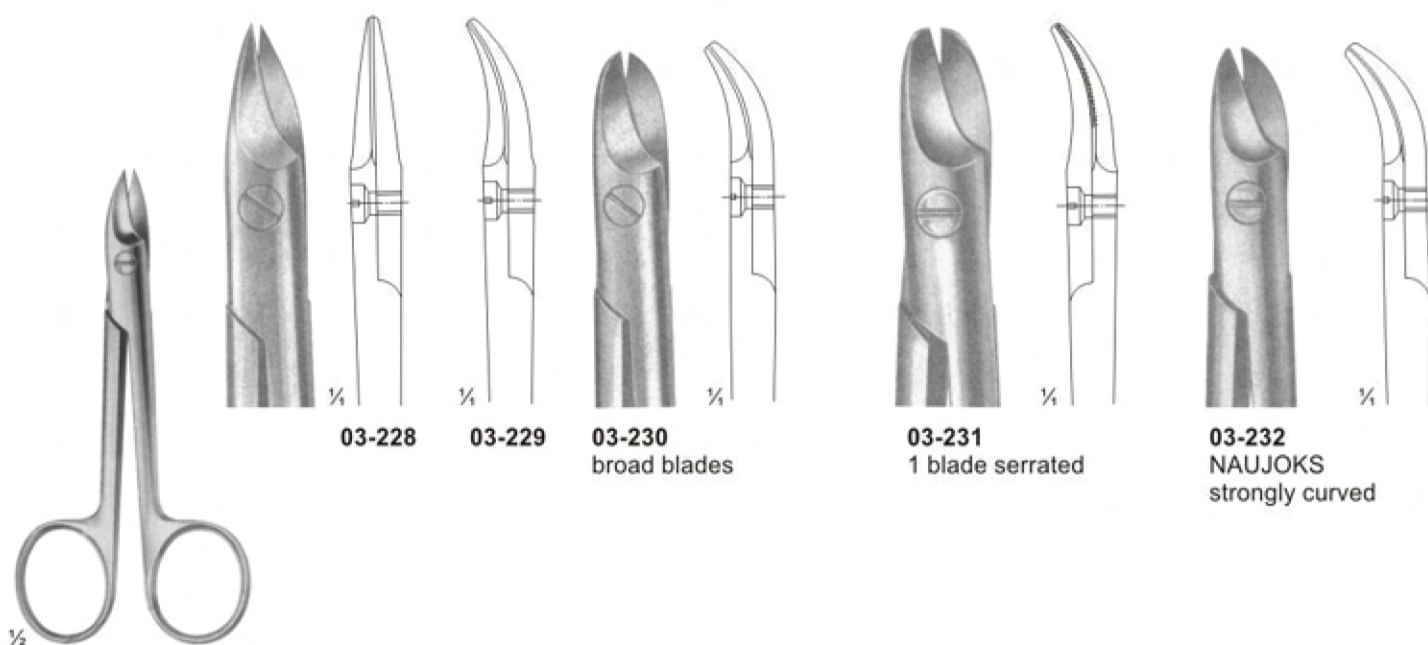

**03-228**

**03-229**

**03-230**  
broad blades

**03-231**  
1 blade serrated

**03-232**  
NAUJOKS  
strongly curved

**03-228 - 03-232**  
BEEBE  
Size: 110 mm

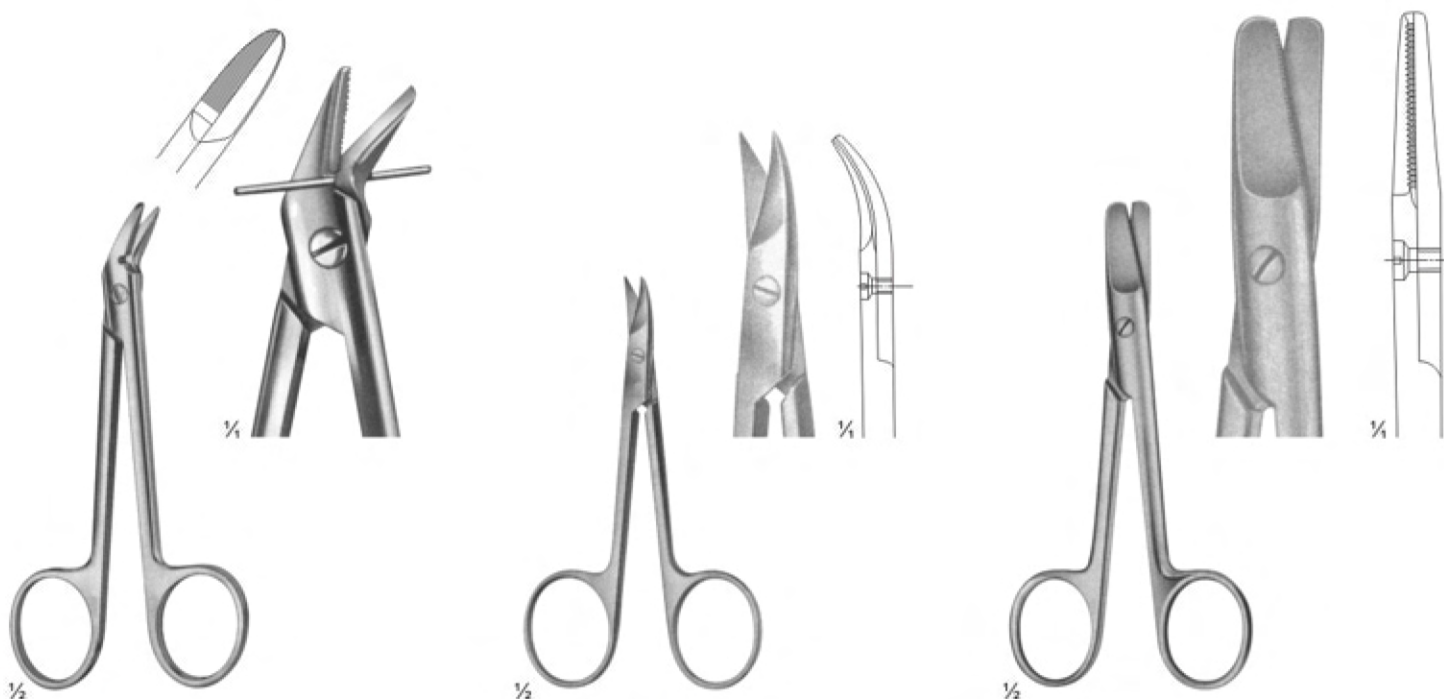

**03-233**  
1 blade serrated  
Size: 120 mm

**03-234**  
STRACK  
Size: 100 mm

**03-235**  
HARVEY  
blades serrated  
Size: 125 mm

# Bandage and Cloth Scissors



**03-236**  
 Universal bandage and cloth scissors,  
 with toothed edges  
 180 mm

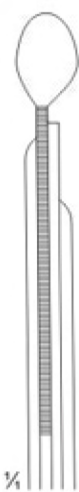

**03-237**  
 LISTER  
 Universal bandage and cloth scissors,  
 with toothed edges  
 Size: 145 mm

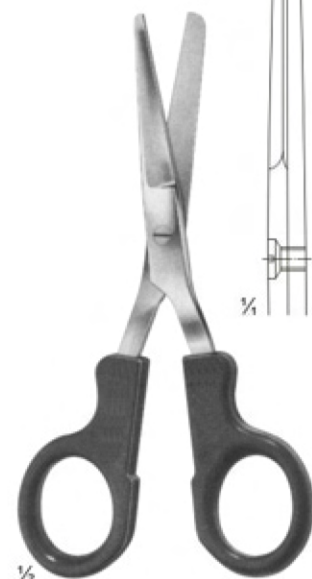

**03-238**  
 LISTER  
 Nurse's scissors  
 Size: 145 mm

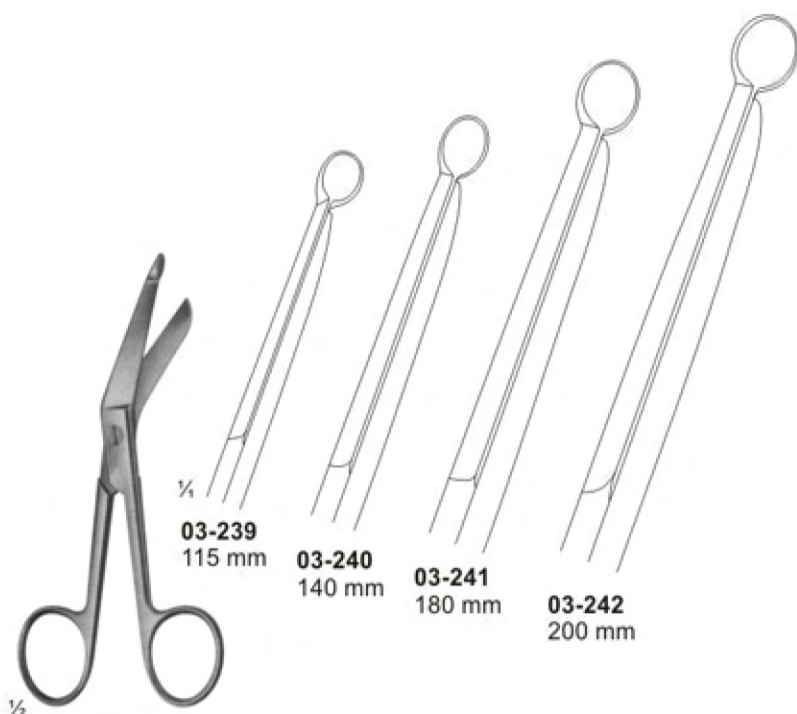

**03-239 - 03-242**  
 LISTER

**03-239**  
 115 mm

**03-240**  
 140 mm

**03-241**  
 180 mm

**03-242**  
 200 mm

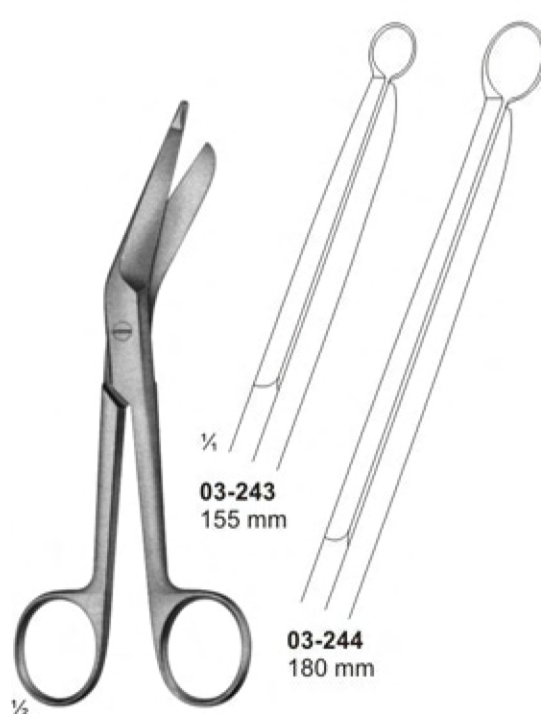

**03-243 - 03-244**  
 LISTER

**03-243**  
 155 mm

**03-244**  
 180 mm

# Bandage-, Cloth-, and Plaster Scissors



**03-245**  
CLOTH SCISSORS  
205 mm

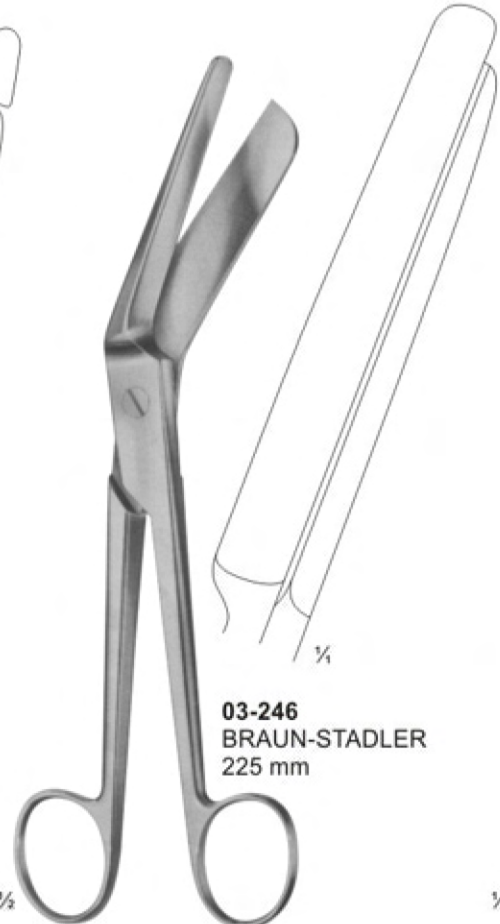

**03-246**  
BRAUN-STADLER  
225 mm



**03-247**  
SEUTIN  
230 mm

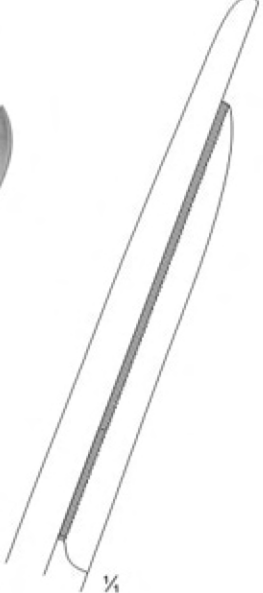

**03-248** 200 mm  
**03-249** 230 mm

**03-248 - 03-249**  
ESMARCH

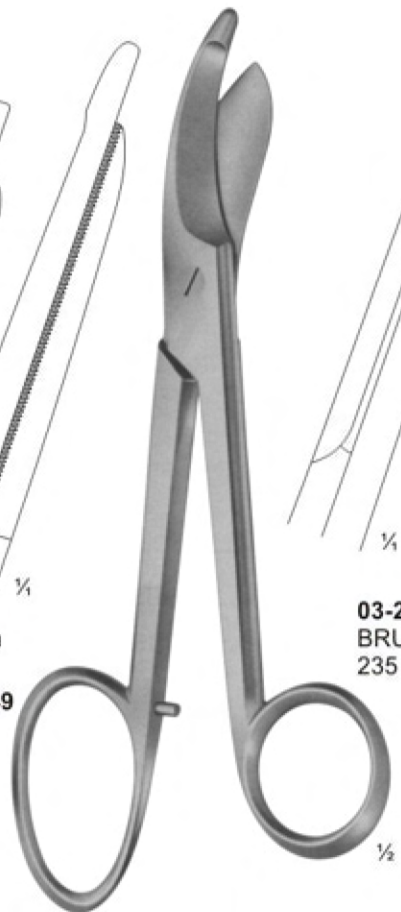

**03-250**  
BRUNS  
235 mm

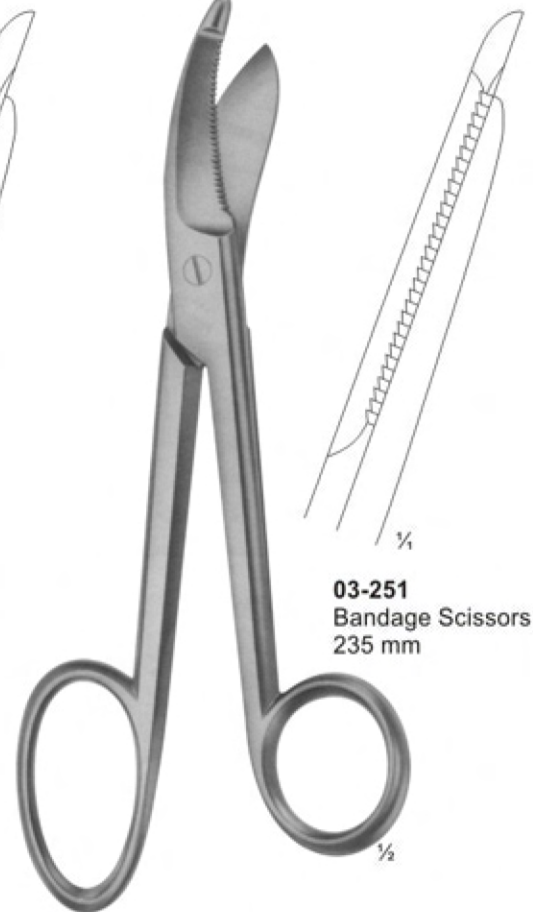

**03-251**  
Bandage Scissors  
235 mm

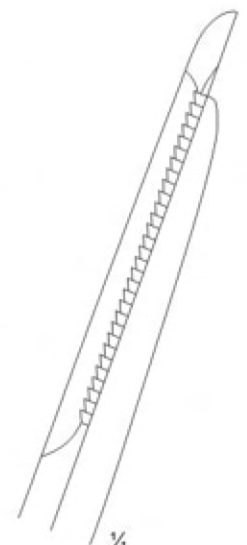



## Forceps for grasping tissue, tumors etc.

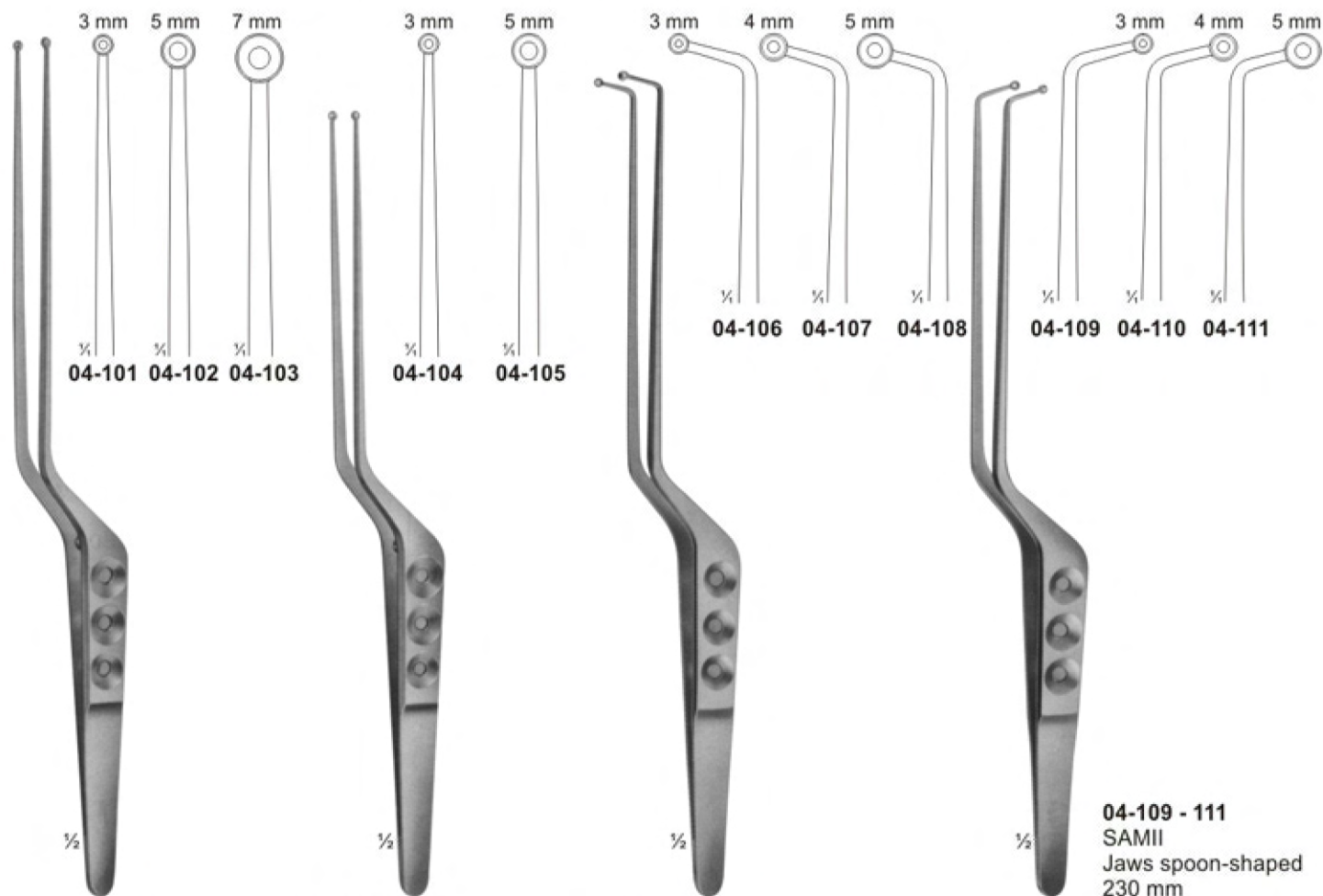

**04-101 - 103**  
YASARGIL-SAMII  
Jaws spoon-shaped  
240 mm

**04-104 - 105**  
YASARGIL  
Jaws spoon-shaped  
220 mm

**04-106 - 108**  
SAMII  
Jaws spoon-shaped  
230 mm

**04-109 - 111**  
SAMII  
Jaws spoon-shaped  
230 mm

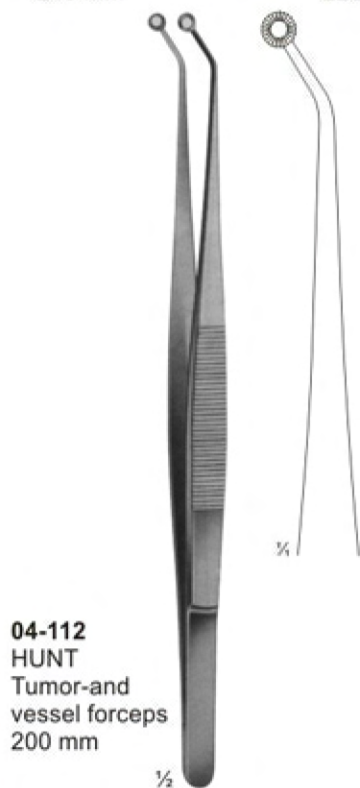

**04-112**  
HUNT  
Tumor-and  
vessel forceps  
200 mm



**04-113**  
HUNT  
Tumor-and  
vessel forceps  
200 mm



**04-114**  
YASARGIL  
Tumor-and  
vessel forceps  
200 mm

# Delicate Dissecting, Microscopic, Sterilizing Forceps

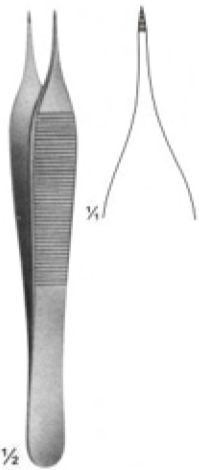

**04-115**  
THORPE  
Corneal forceps  
120 mm

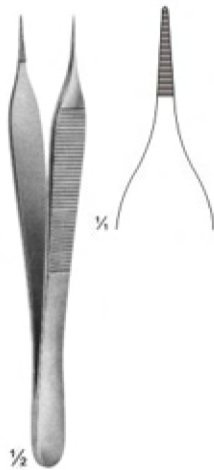

**04-116**  
MICRO-ADSON  
120 mm

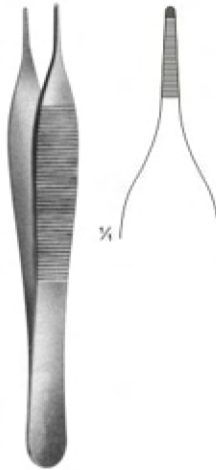

**04-117**  
ADSON  
120 mm



**04-118**  
MICRO-ADSON  
150 mm



**04-119 - 121**  
100 mm



**04-119**



**04-120**



**04-121**

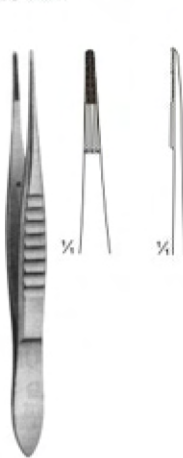

**04-122**  
BONACCOLTO  
110 mm

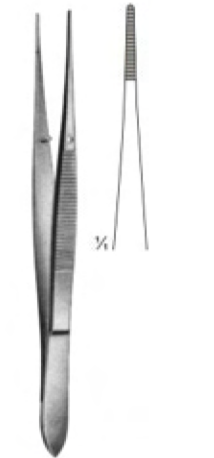

**04-123**  
115 mm

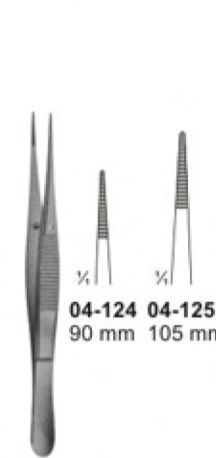

**04-124 - 133**

**04-124**

**04-125**

**04-126**

**04-127**

**04-128**

**04-129**

**04-130**

**04-131**

**04-132**

**04-133**

90 mm

105 mm

115 mm

130 mm

145 mm

90 mm

105 mm

115 mm

130 mm

145 mm



**04-134**  
100 mm

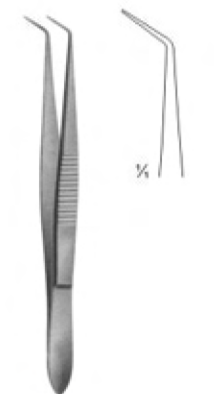

**04-135**  
100 mm

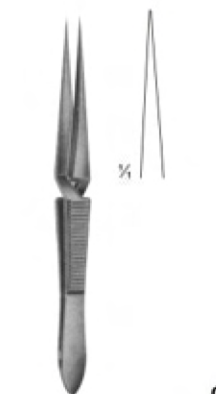

**04-136**  
100 mm

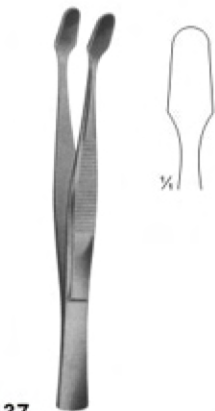

**04-137**  
KUHNE  
Cover glass forceps, 105 mm

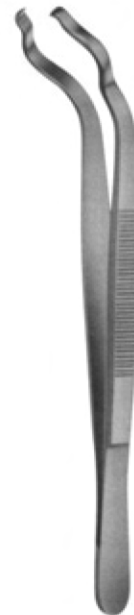

**04-138**  
160 mm

# Delicate Dissecting Forceps

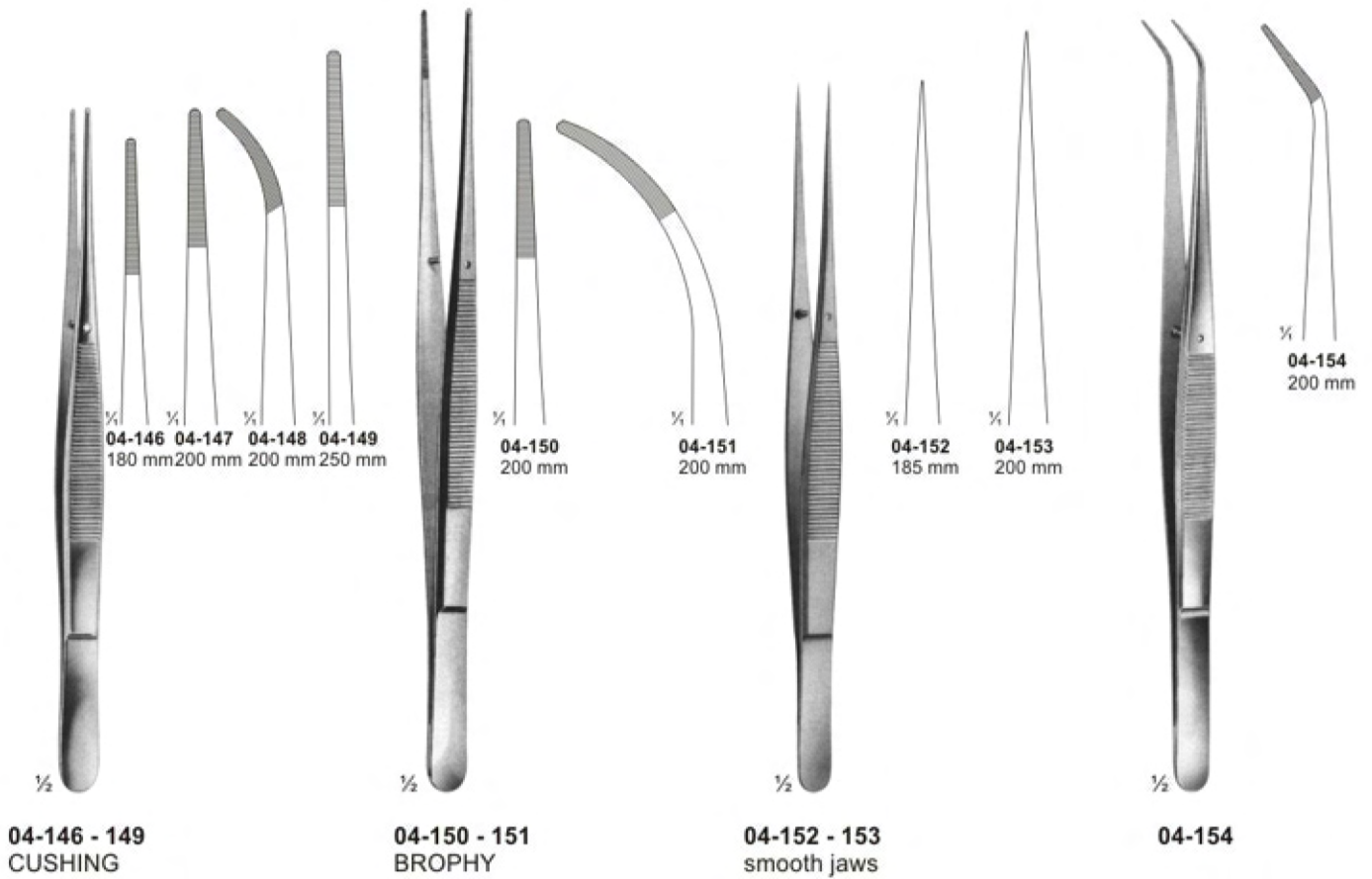
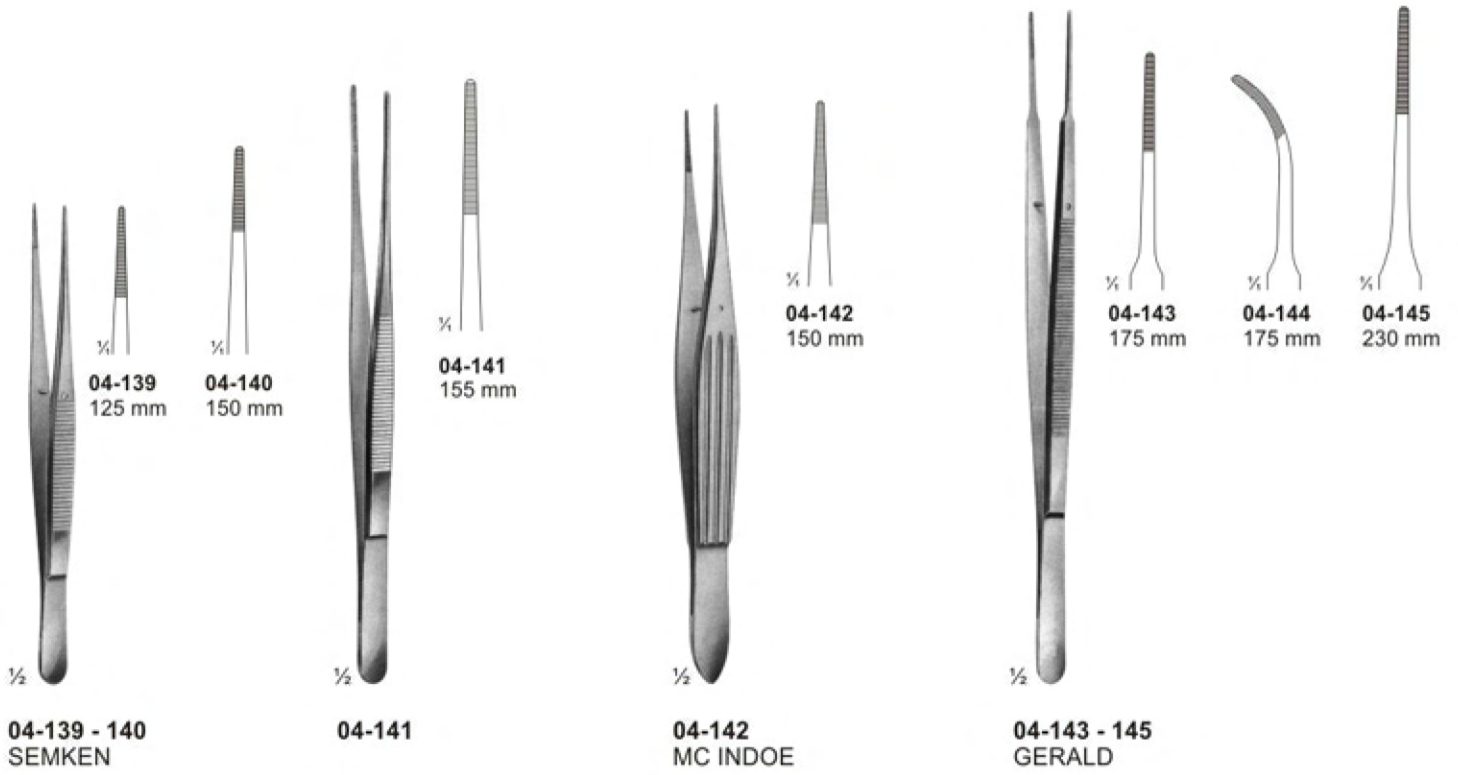



# Dissecting Forceps

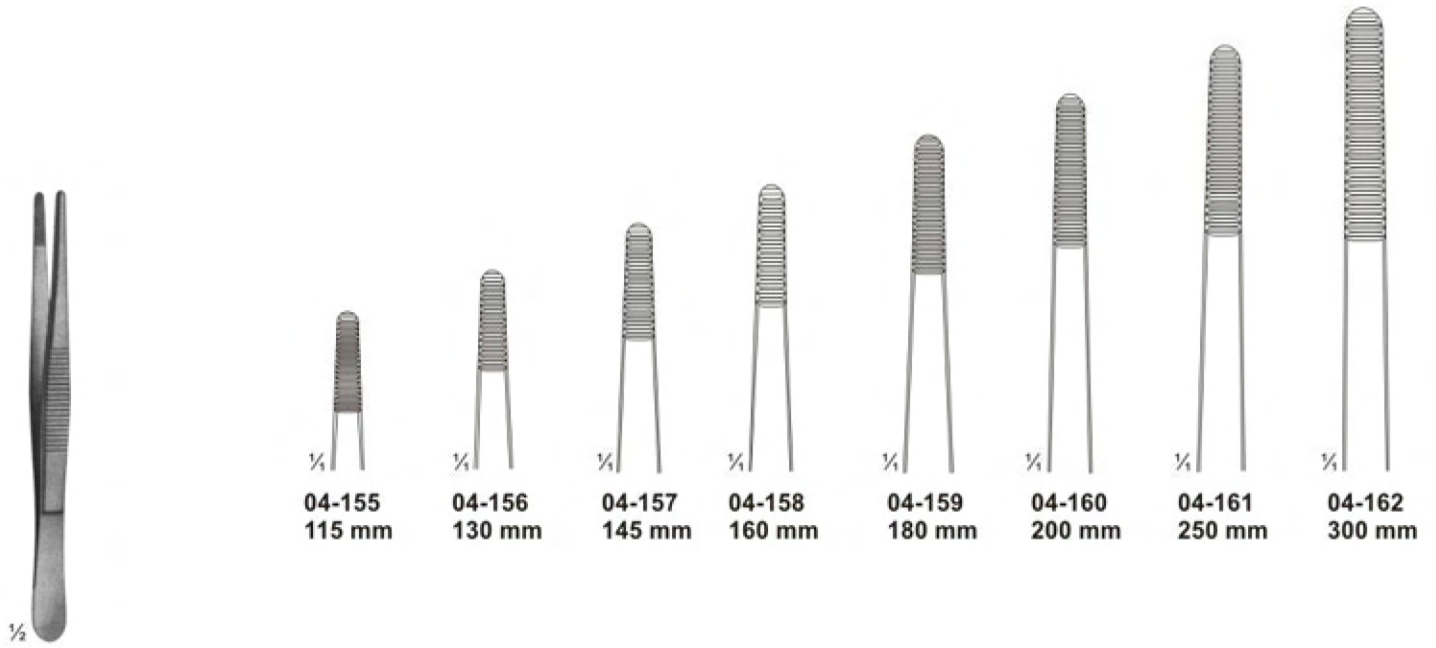

04-155 - 04-162  
STANDARD

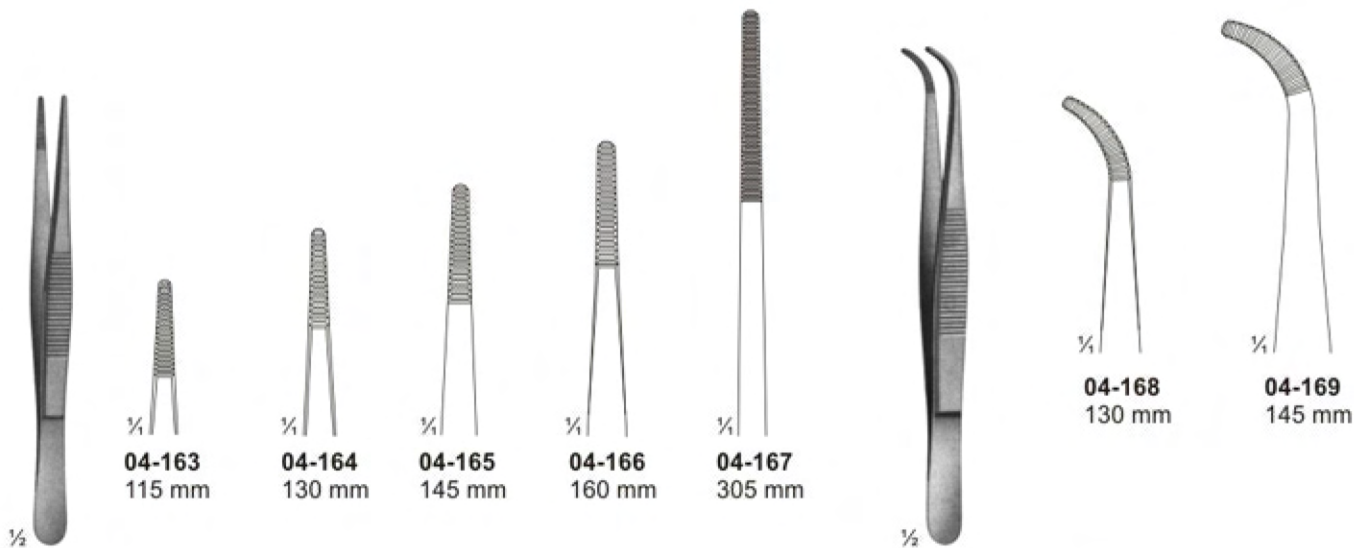

04-163 - 04-167  
MEDIUM

04-168 - 04-169  
MEDIUM

# Forceps

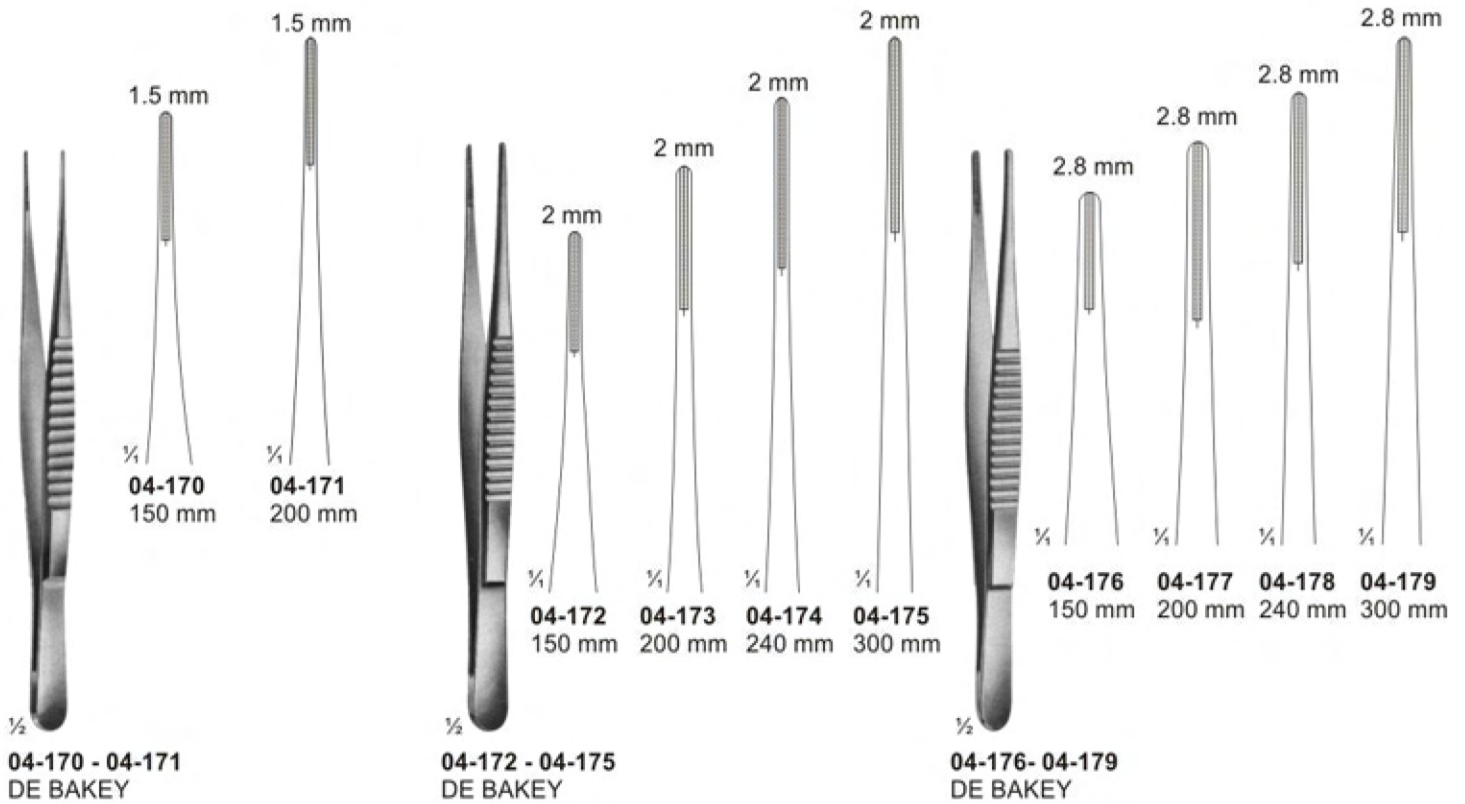

# Delicate Tissue Forceps

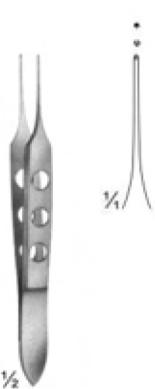

**04-185**  
BISHOP-HARMON  
85 mm

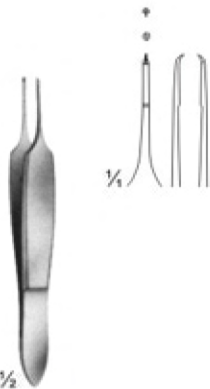

**04-186**  
ST.MARTIN  
80 mm

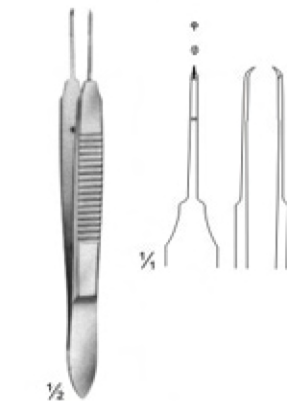

**04-187**  
CASTROVIEJO  
teeth 0.9 mm  
100 mm

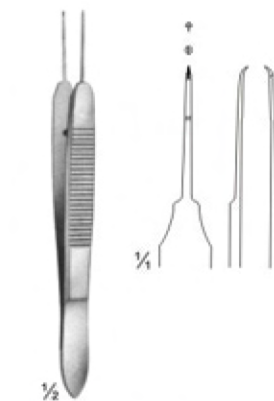

**04-188**  
CASTROVIEJO  
teeth 0.5 mm  
100 mm

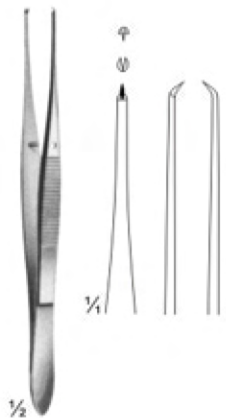

**04-189**  
ELSCHING  
110 mm

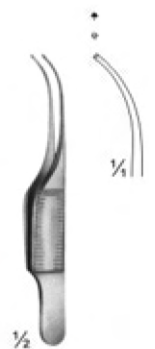

**04-190**  
GILL  
75 mm

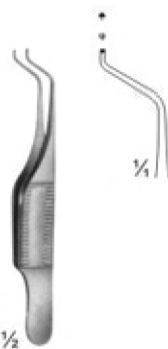

**04-191**  
GILL - HESS  
75 mm

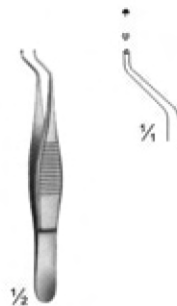

**04-192**  
HESS  
70 mm

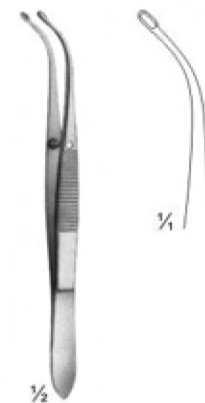

**04-193**  
ARRUGA  
100 mm

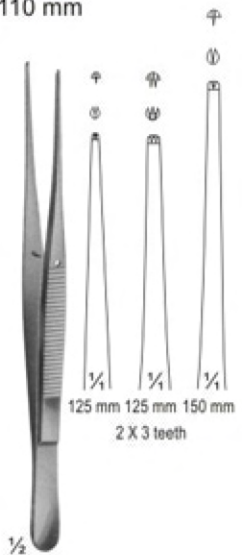

**04-194**  
SEMKEN  
125 mm 125 mm 150 mm  
2 X 3 teeth

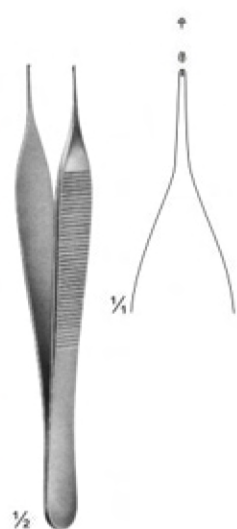

**04-195**  
MICRO-ADSON  
120 mm

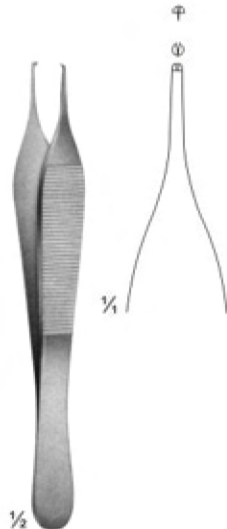

**04-196**  
ADSON  
120 mm

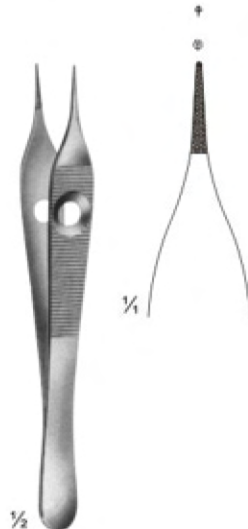

**04-197**  
ADSON  
120 mm



**04-198**  
ADSON  
120 mm



**04-199**  
ADSON  
150 mm



# Tissue Forceps

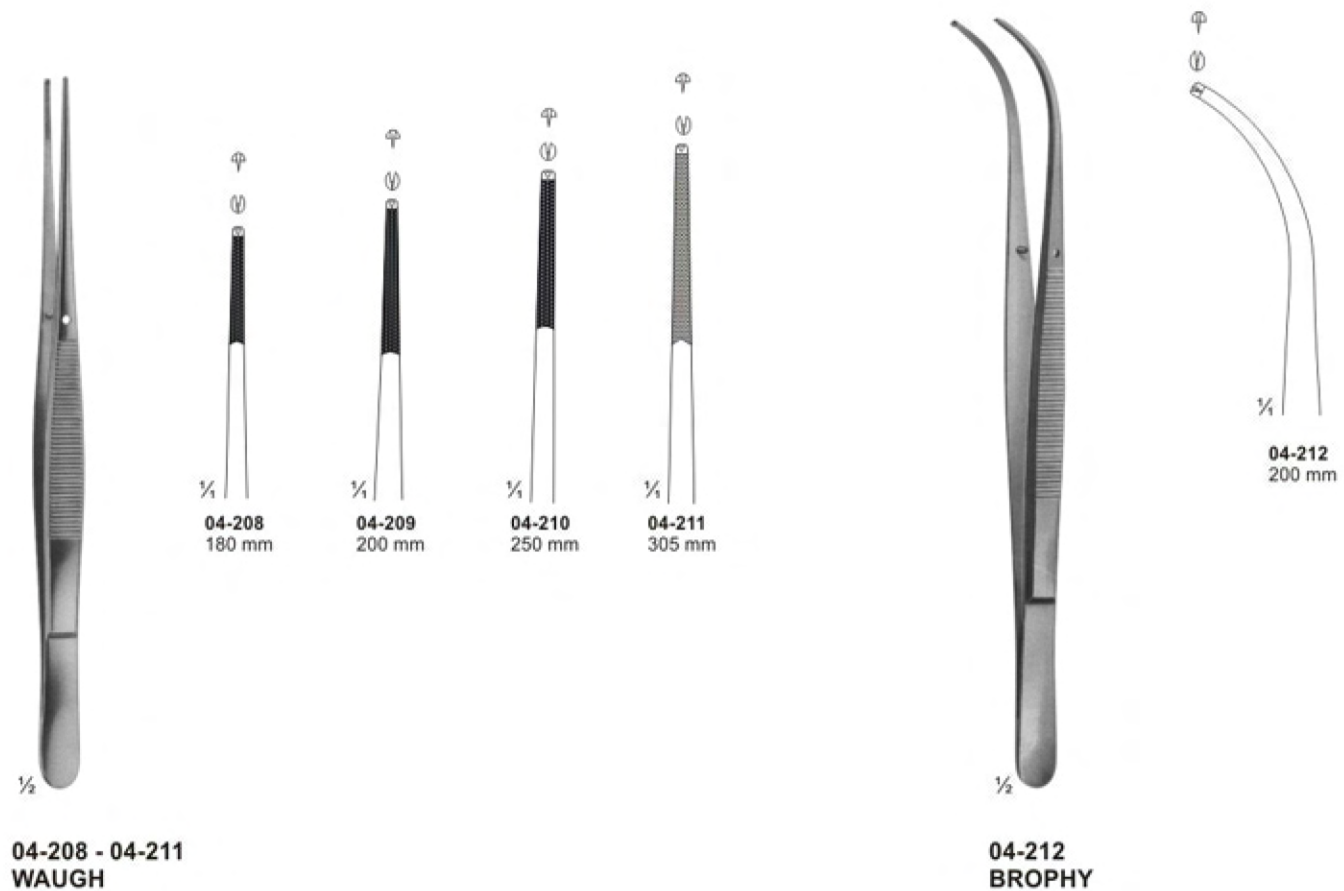
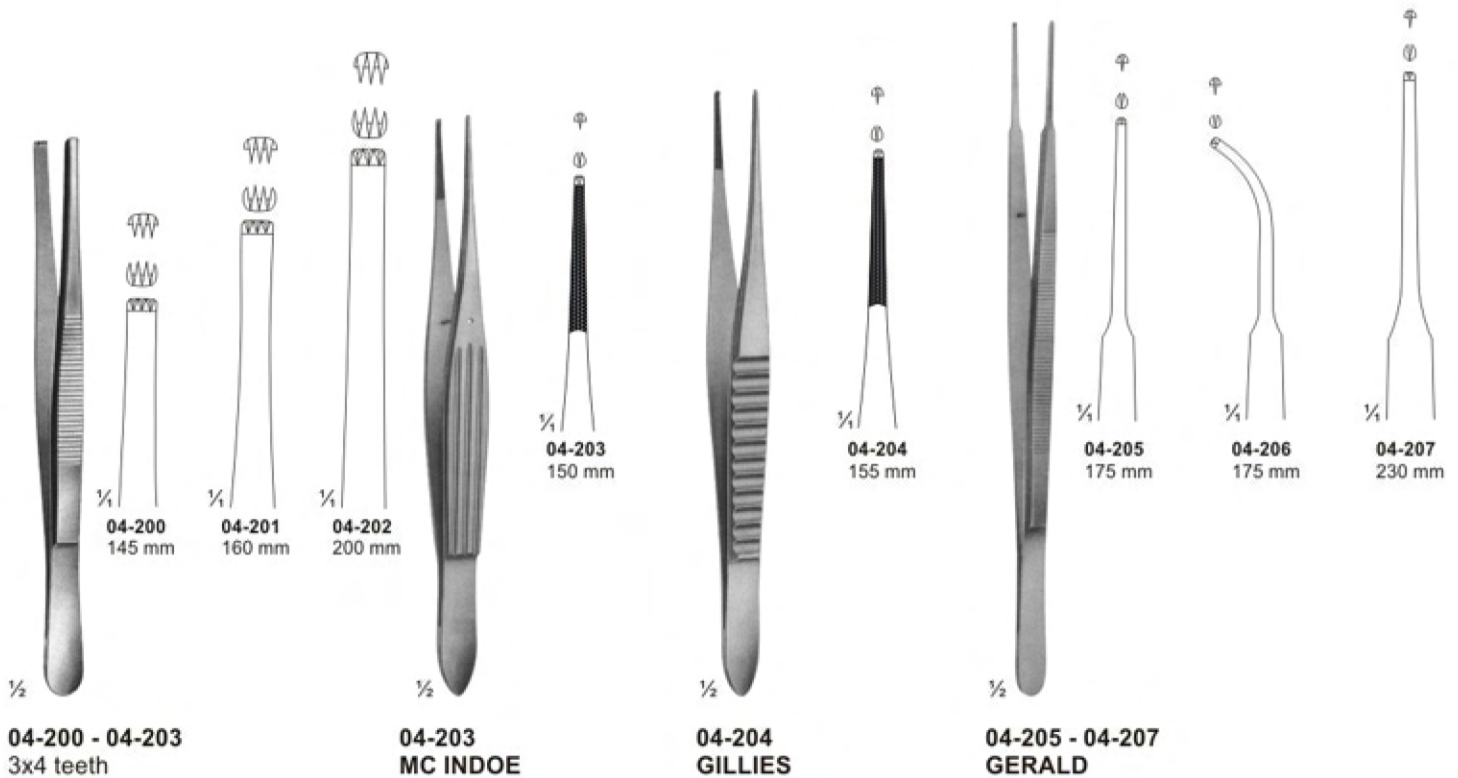

# Tissue Forceps

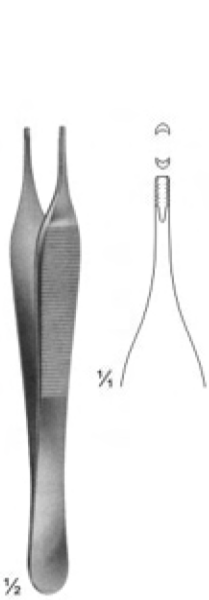

**04-213**  
**ADSON - BROWN**  
Non-traumatic  
120 mm

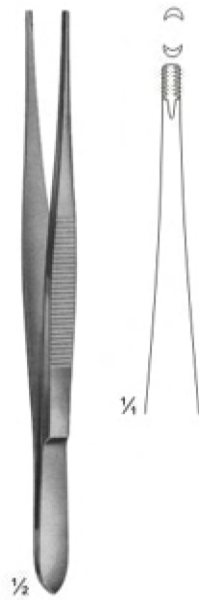

**04-214**  
**BROWN**  
120 mm

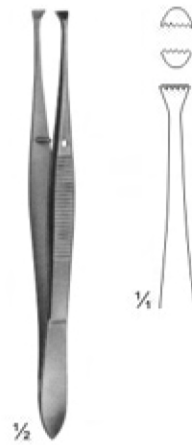

**04-215**  
**GRAEFE**  
110 mm

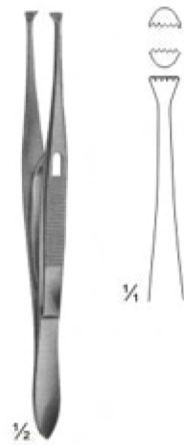

**04-216**  
**GRAEFE**  
With Catch  
110 mm

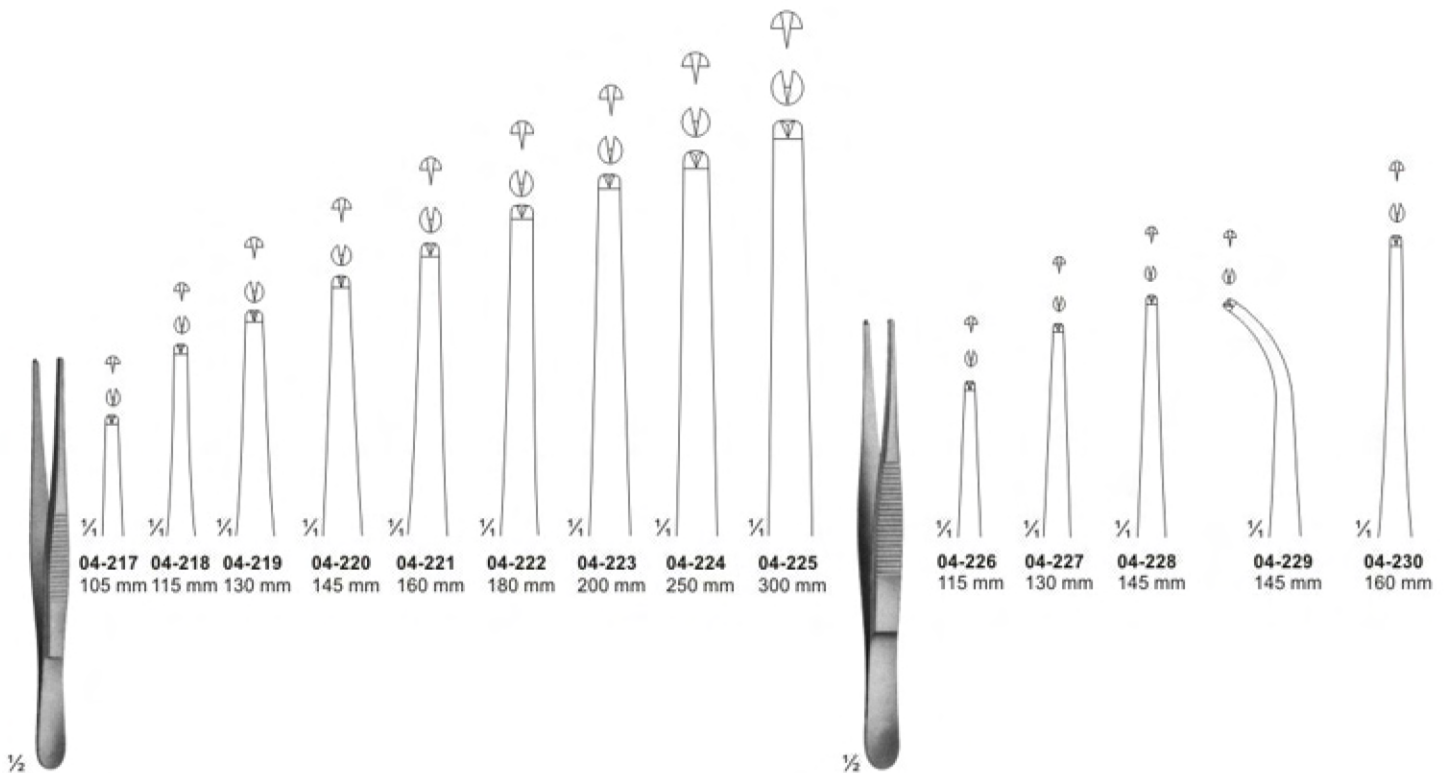

**04-217 - 04-225**  
**STANDARD**

**04-226 - 04-230**  
**GRAEFE**  
110 mm

## Forceps, Bayonet - Shaped



**04-231**  
LUCAE  
140 mm



**04-232**  
LUCAE  
1x2 teeth  
140 mm

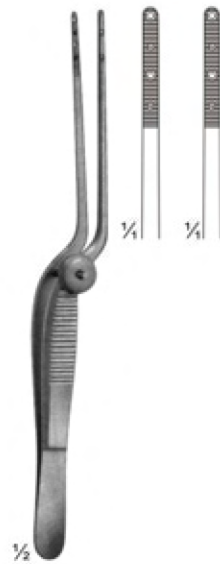

**04-233**  
COTTLE  
Forceps with  
jaws toothed  
and serrated  
140 mm

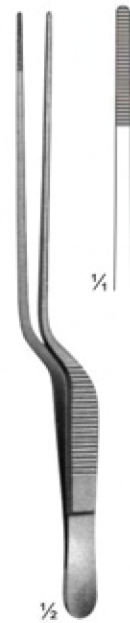

**04-234**  
JANSEN  
160 mm

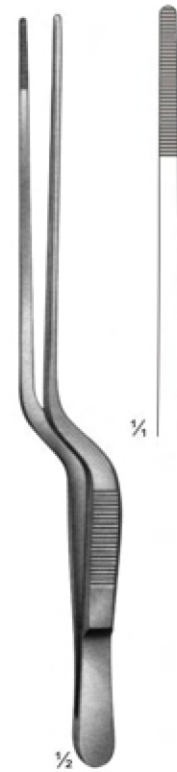

**04-235**  
GRUENWALD  
200 mm



**04-236**  
1x2 teeth  
200 mm

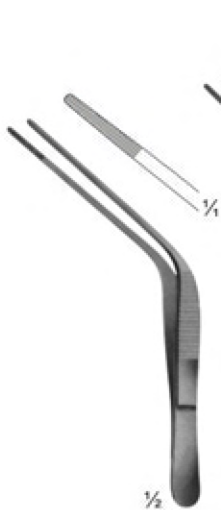

**04-237**  
TROELTSCH  
100 mm

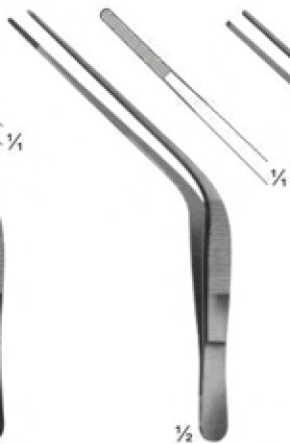

**04-238**  
TROELTSCH  
115 mm

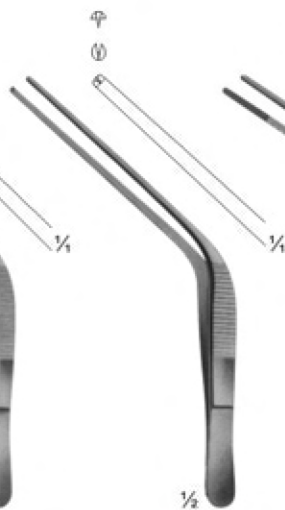

**04-239**  
TROELTSCH  
1X2 teeth  
115 mm

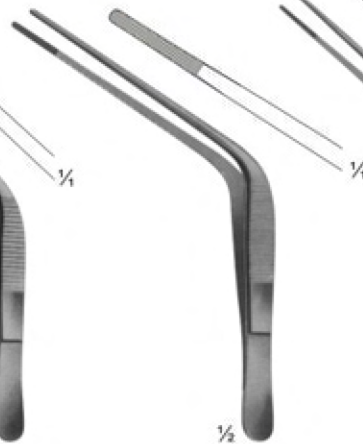

**04-240**  
WILDE  
115 mm

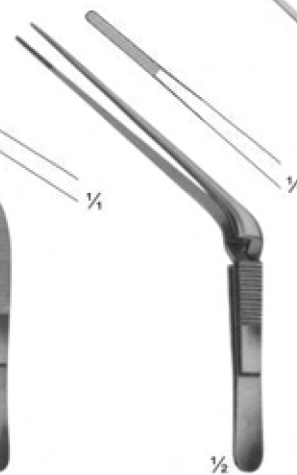

**04-241**  
TROELTSCH  
Cross action  
120 mm



**04-242**  
TROELTSCH  
140 mm



# Tissue Forceps, Lung Dissecting Forceps

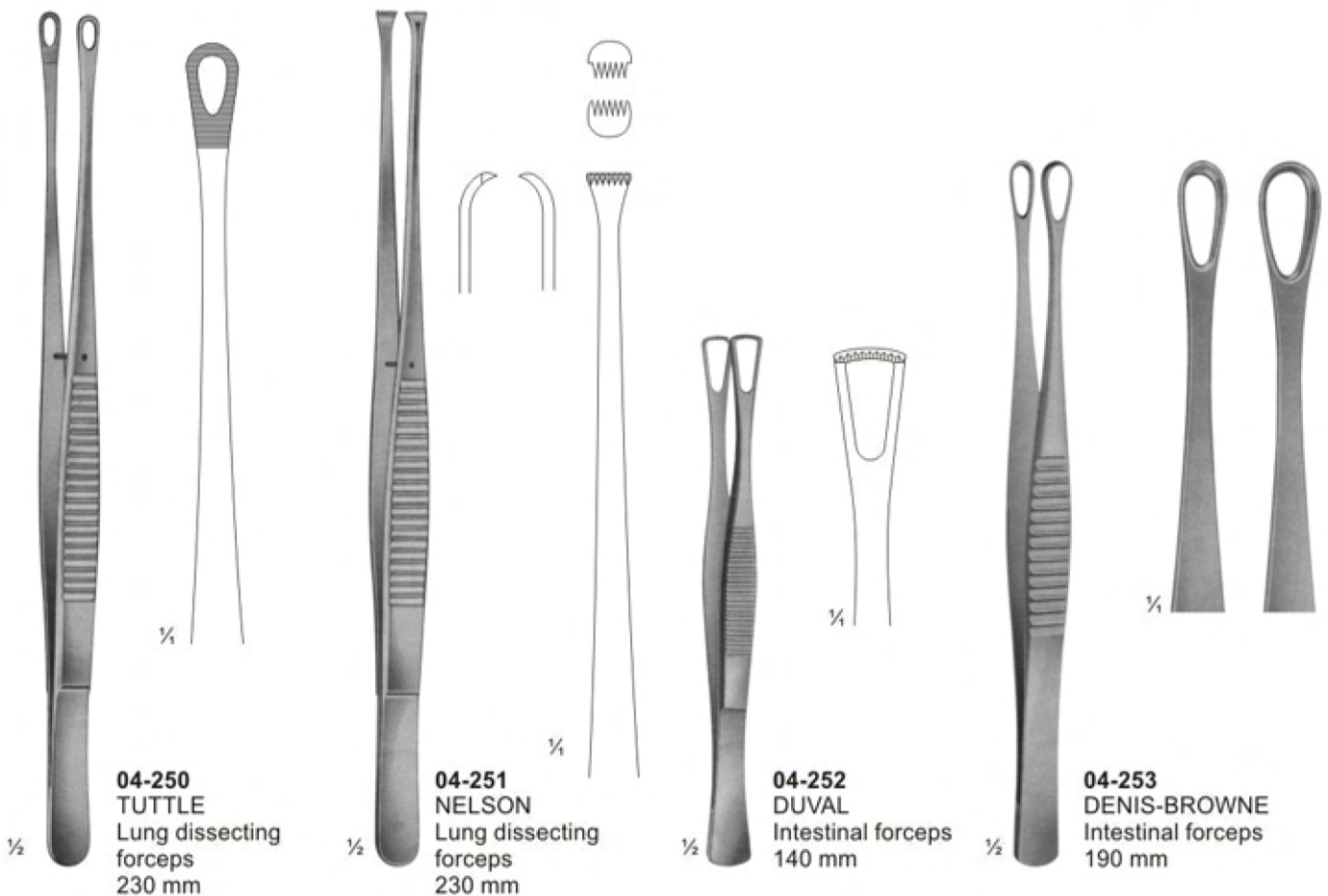
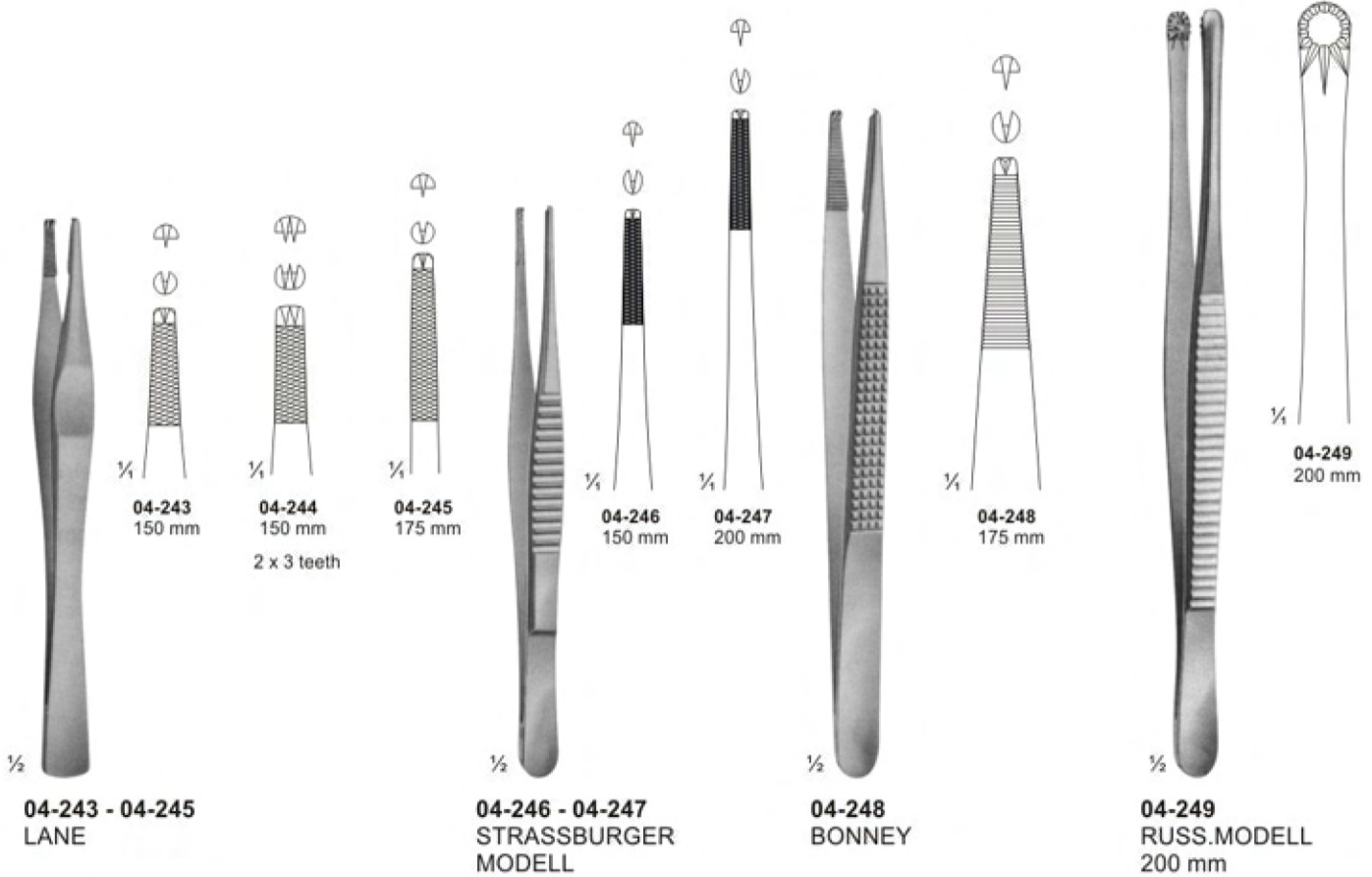

# Splinter and Cilia Forceps

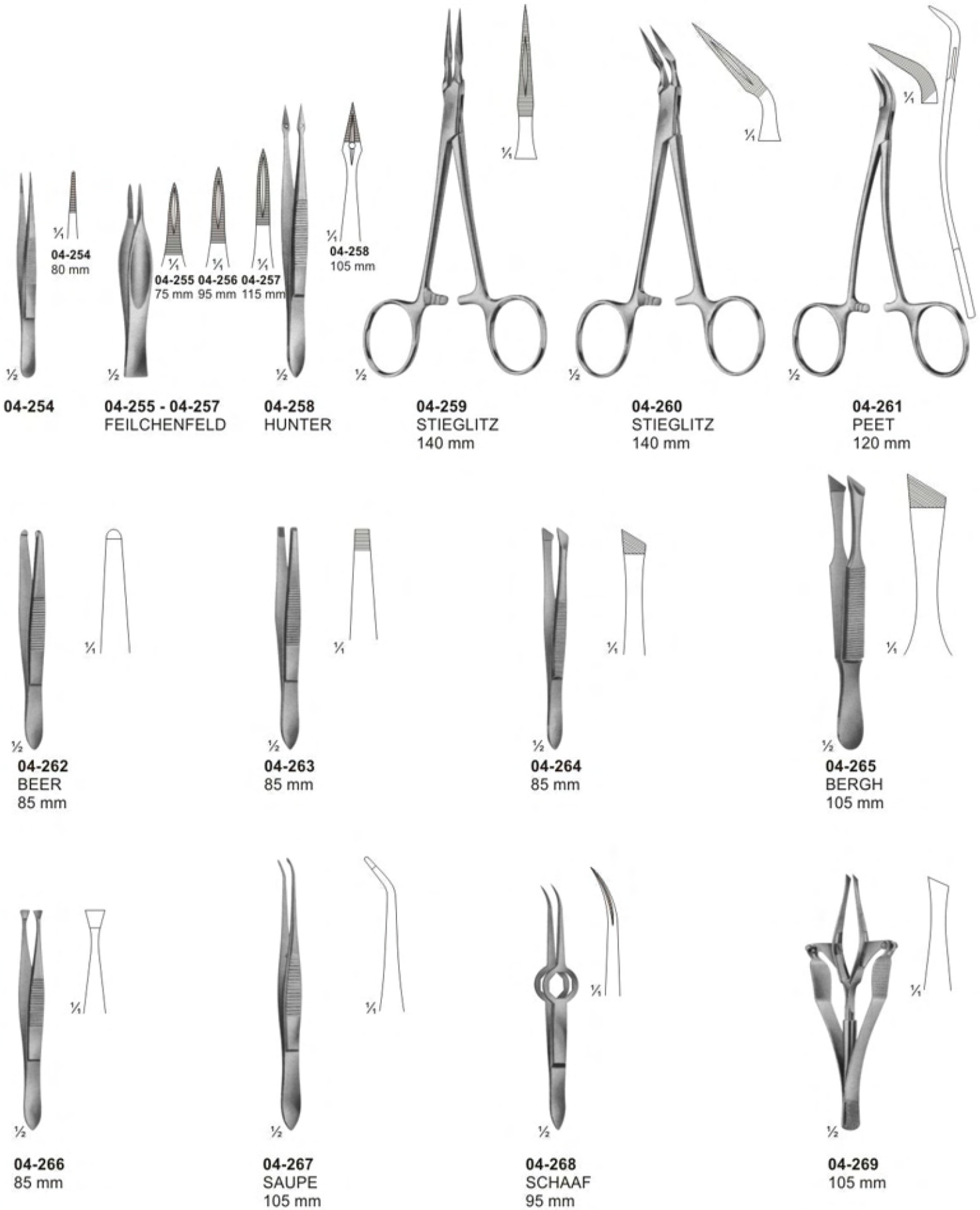

# Sponge and Dressing Forceps

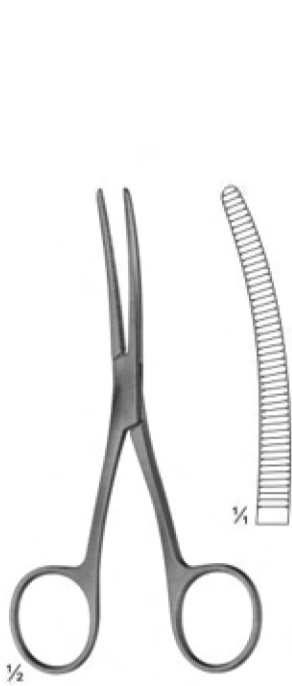

**04-270**  
BRYANT  
130 mm

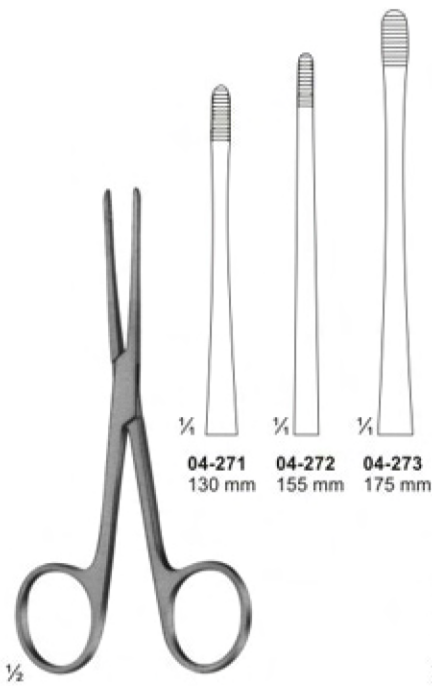

**04-271 - 04-273**  
LISTER  
Sinus forceps

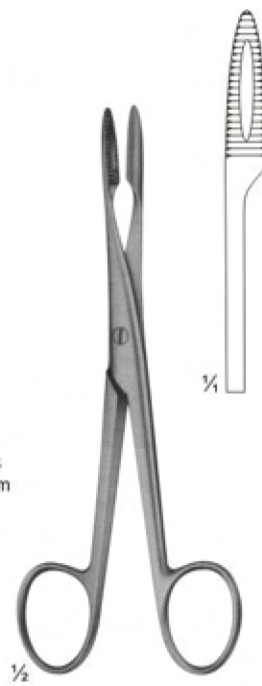

**04-274**  
without ratchet  
145 mm

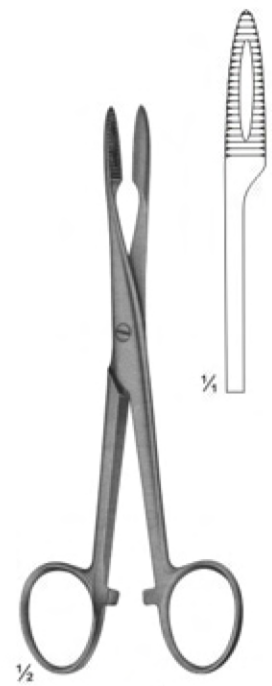

**04-275**  
with ratchet  
145 mm

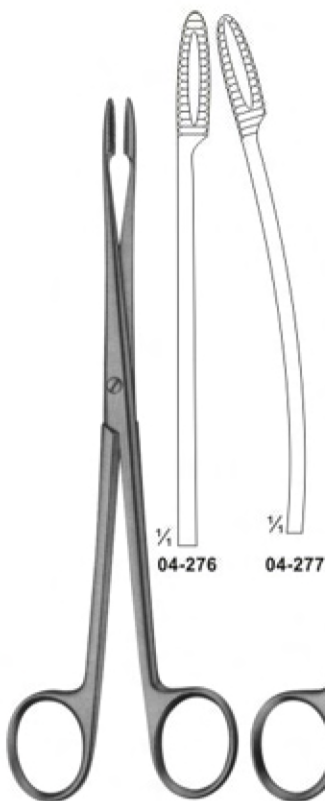

**04-276 - 04-277**  
GROSS  
without ratchet  
180 mm

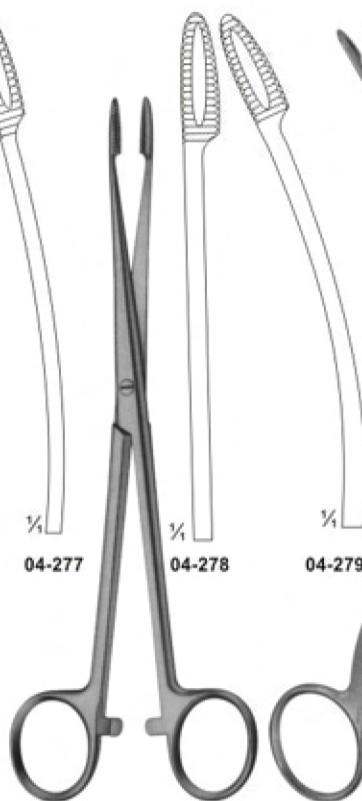

**04-278 - 04-279**  
GROSS  
with ratchet  
180 mm

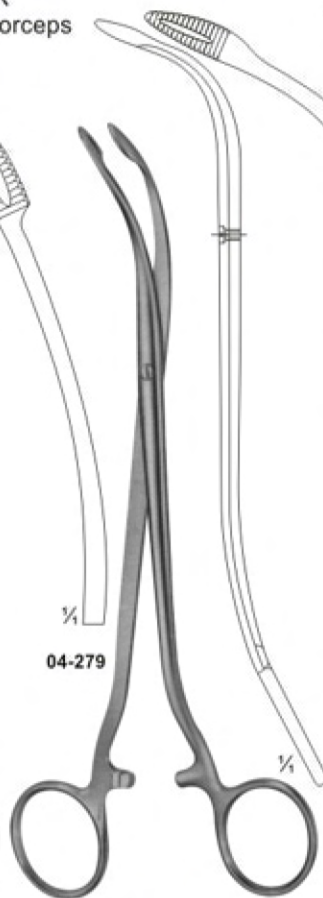

**04-280**  
DUPLAY  
190 mm

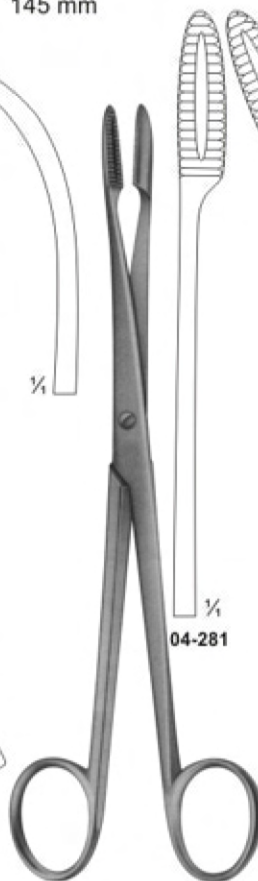

**04-281 - 04-282**  
GROSS  
without ratchet  
200 mm

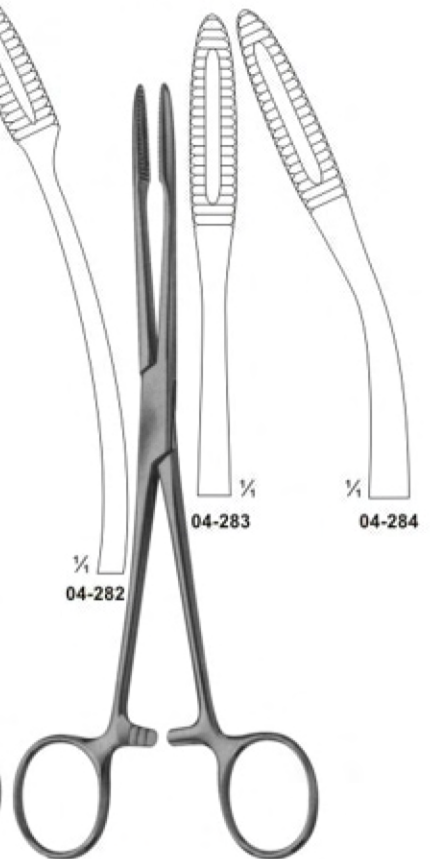

**04-283 - 04-284**  
GROSS  
200 mm



# Dressing-, Sponge holding-, Organ- and Tissue Grasping Forceps

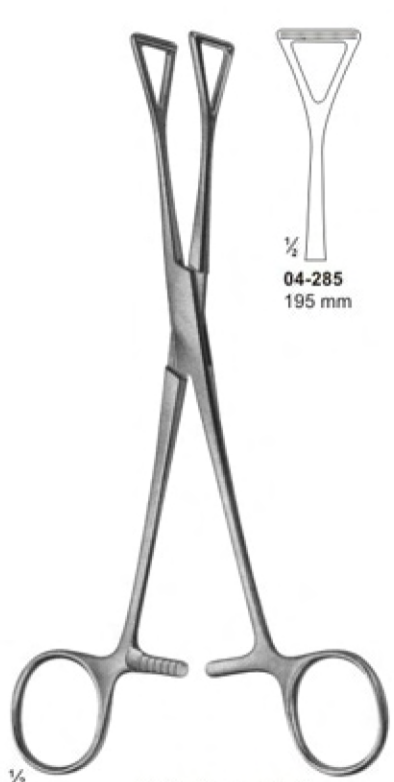

04-285  
195 mm

04-286  
230 mm

04-285 - 04-286  
COLLIN

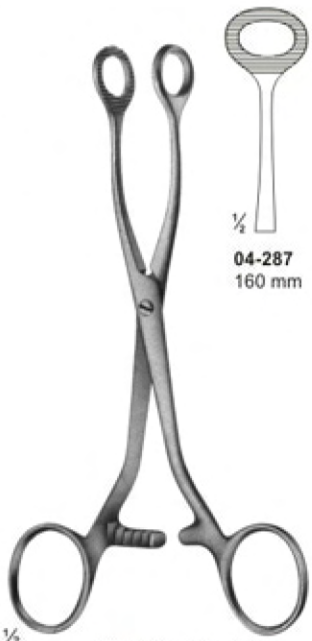

04-287  
160 mm

04-288  
160 mm

04-289  
170 mm

04-287 - 04-289  
COLLIN

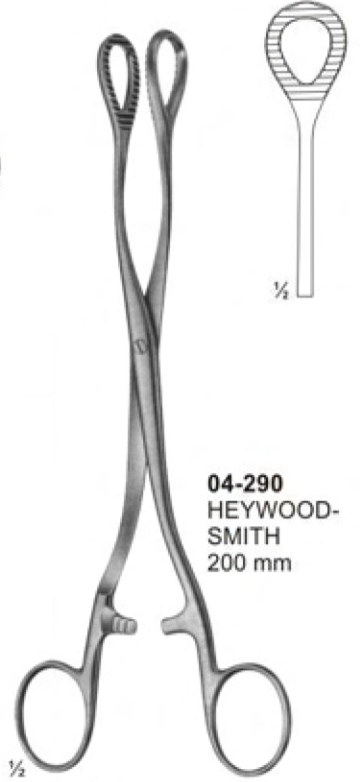

04-290  
HEYWOOD-  
SMITH  
200 mm

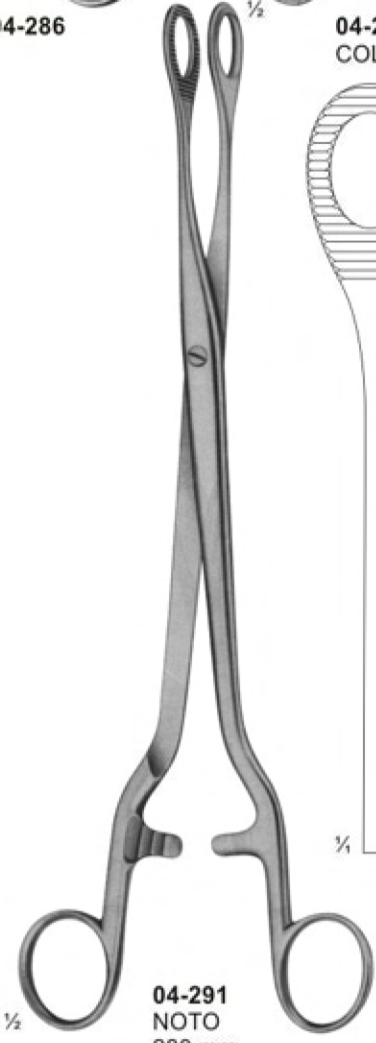

04-291  
NOTO  
280 mm

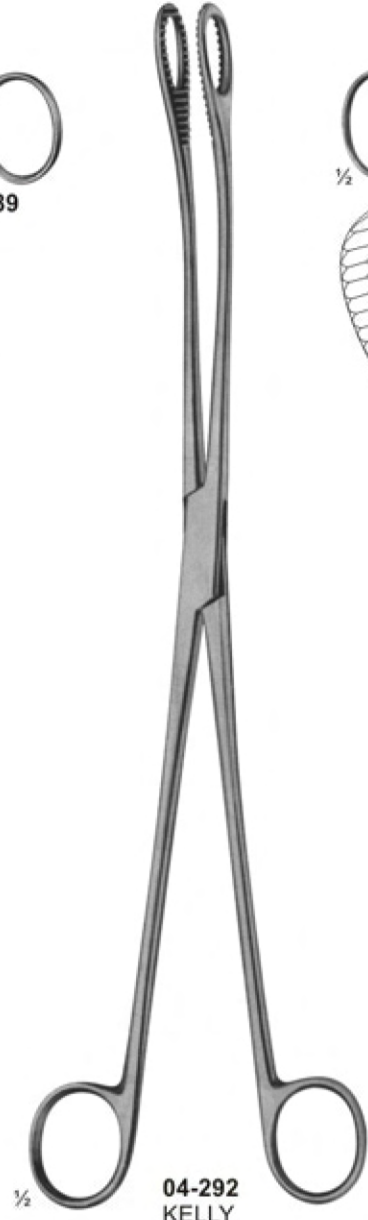

04-292  
KELLY  
320 mm

# Dressing, Sponge holding, Organ and Tissue Grasping Forceps

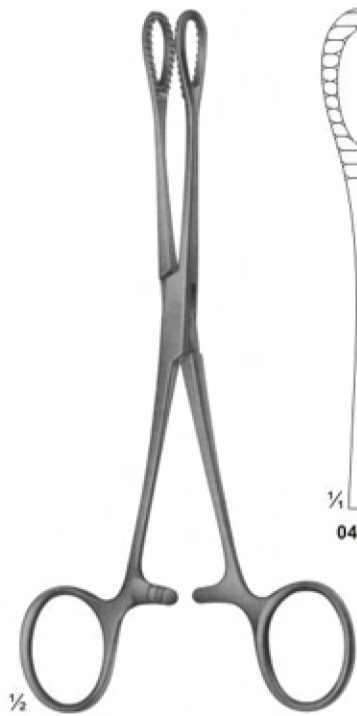

04-293



04-294

1/2  
**04-293 - 04-294**  
FOERSTER-BALLENGER  
180 mm



04-295  
180 mm



04-296  
250 mm

04-295 - 04-296  
RAMPLEY



04-297  
Smooth Jaws



04-298  
Smooth Jaws

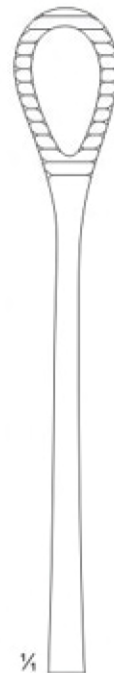

04-299  
Serrated Jaws



04-300  
Serrated Jaws

1/2  
**04-297 - 04-300**  
FOERSTER-BALLENGER  
240 mm

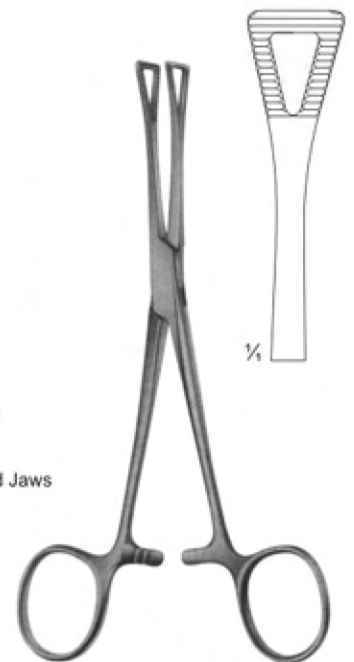

**04-301**  
PENNINGTON  
155 mm

# Intestinal Grasping Forceps

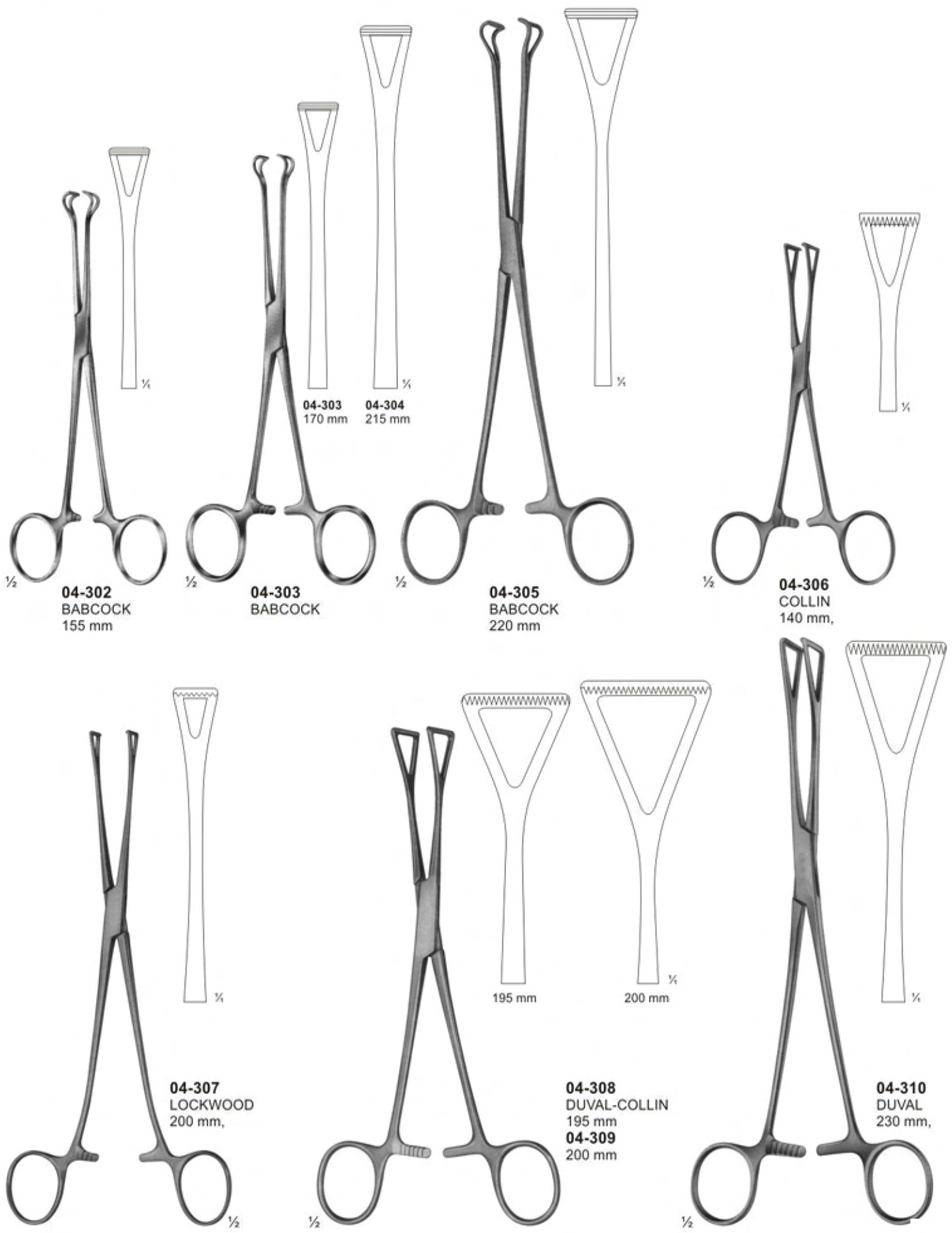

## Artery Traction - and Tissue Grasping Forceps

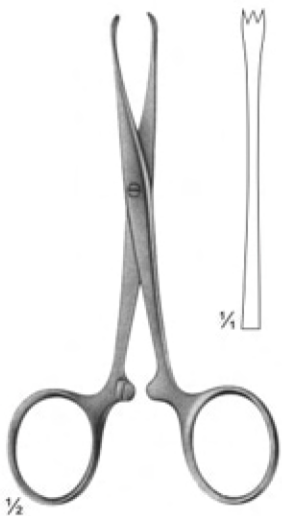

**04-311**  
CHAPUT  
2 x 3 teeth  
125 mm

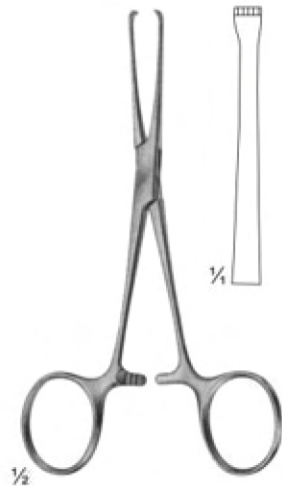

**04-312**  
BABY-ALLIS  
4 x 5 teeth  
130 mm

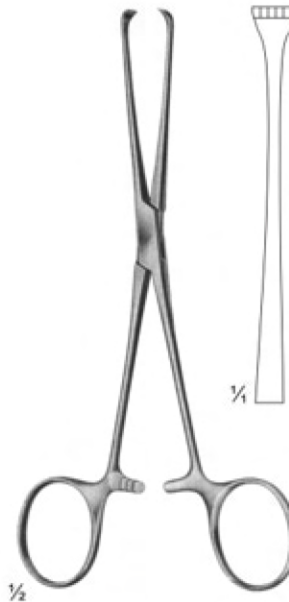

**04-313**  
BOYS-ALLIS  
5 x 6 teeth sharp  
155 mm

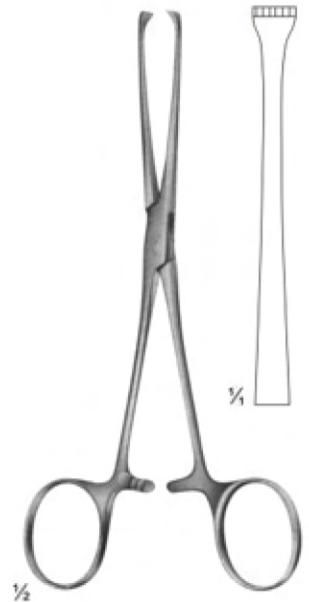

**04-314**  
ALLIS  
5 x 6 teeth  
155 mm



**04-315**  
LAHEY  
155 mm

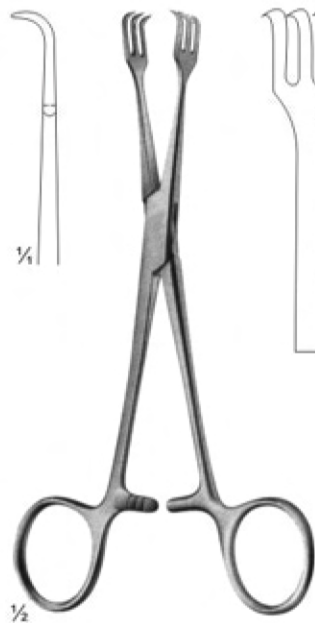

**04-316**  
LAHEY  
155 mm

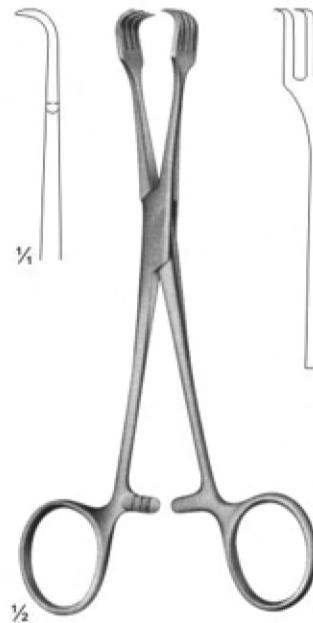

**04-317**  
BRAUN  
155 mm

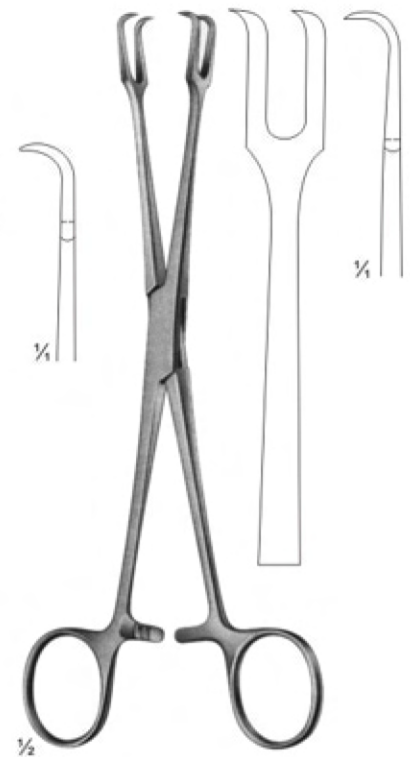

**04-318**  
MUSEUX  
200 mm



# Towel Clamps

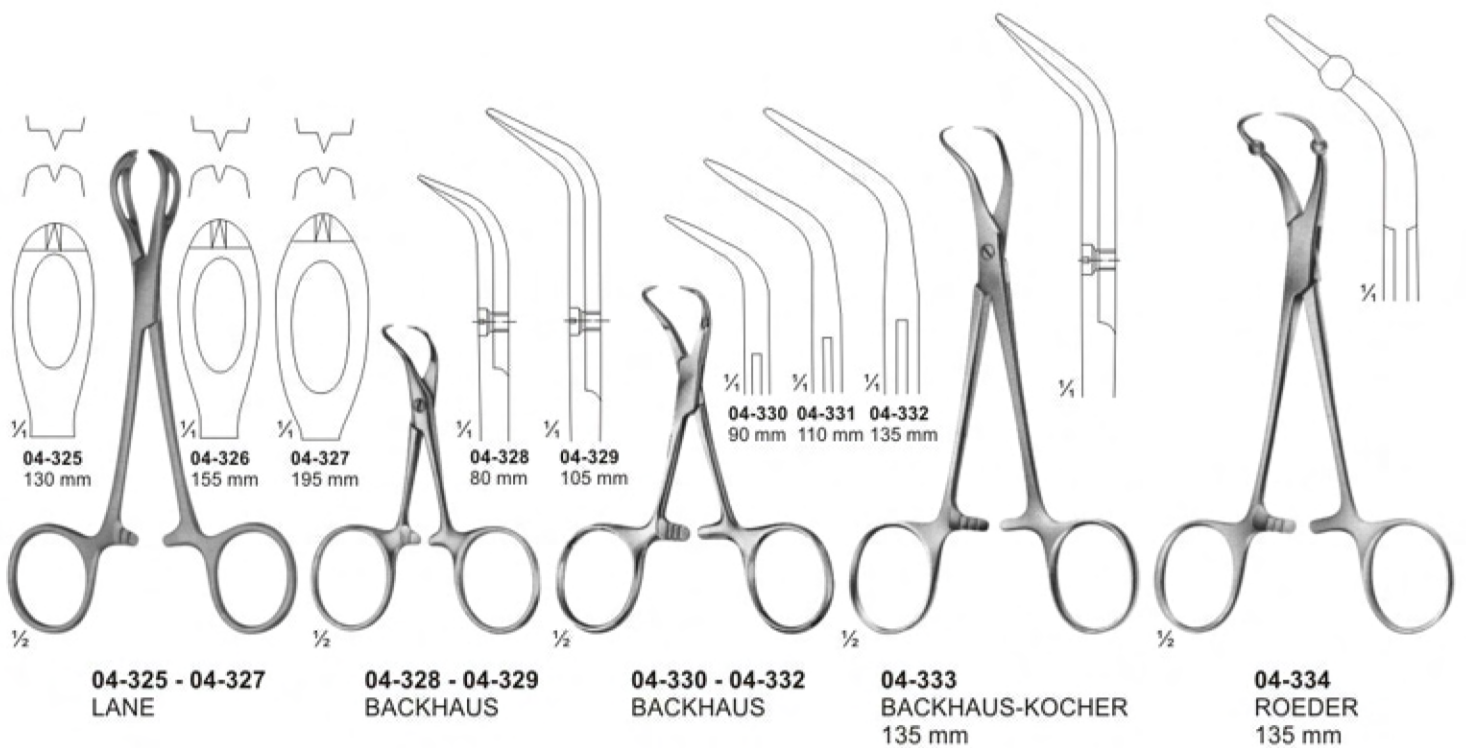
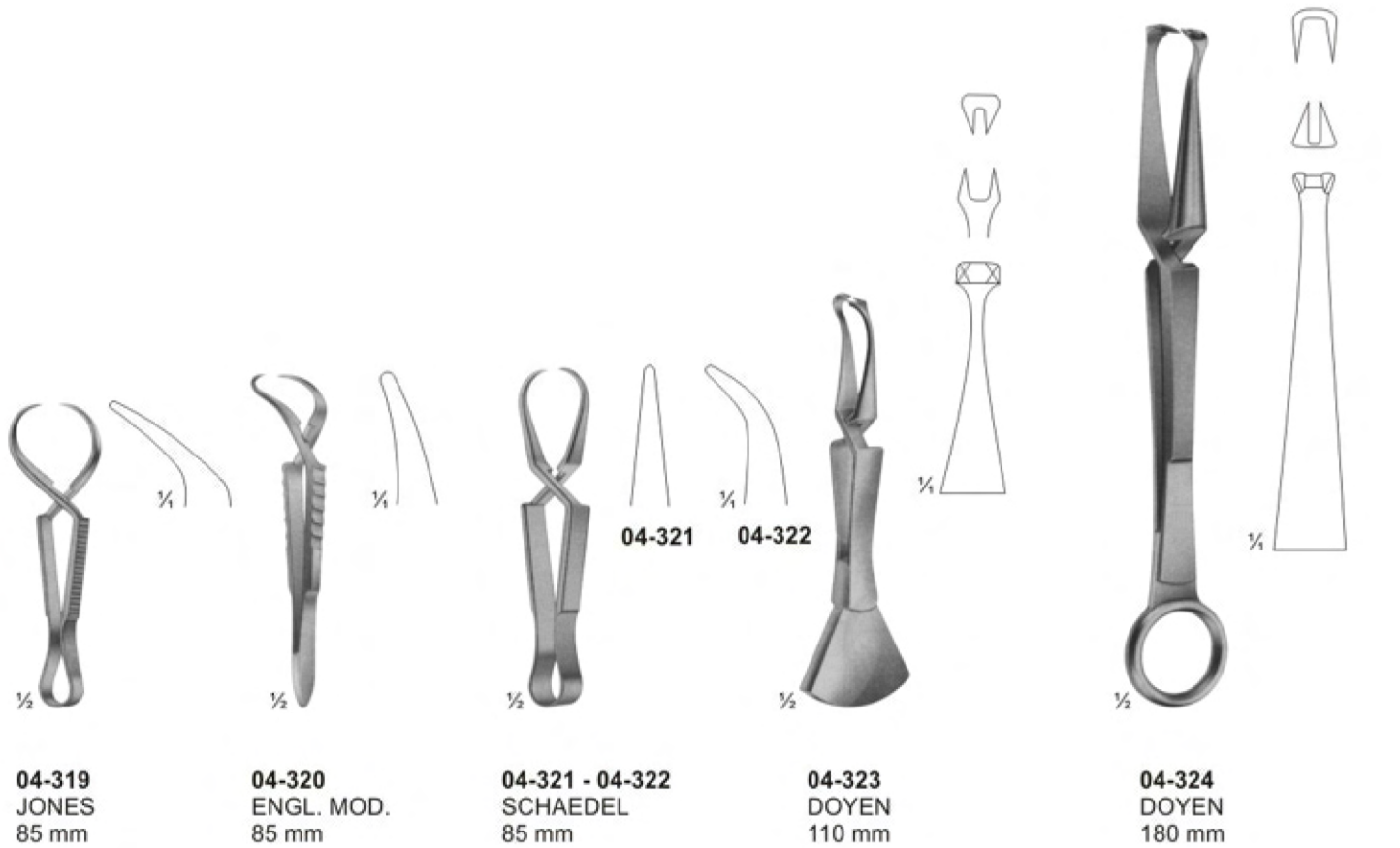

# Muller Vessel Clips and Bulldog Clamps

## Closing force

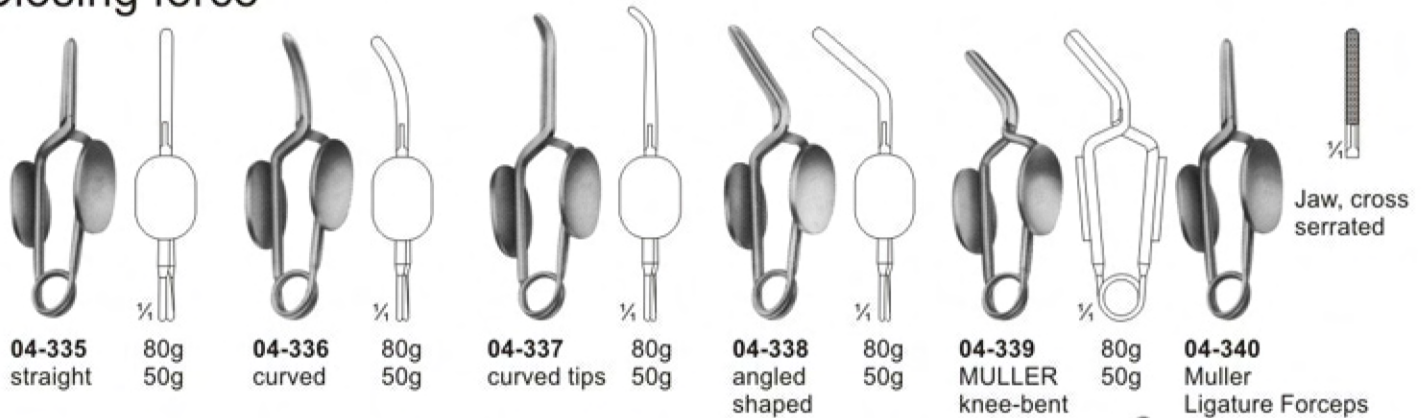

**04-335** straight 80g 50g  
**04-336** curved 80g 50g  
**04-337** curved tips 80g 50g  
**04-338** angled shaped 80g 50g  
**04-339** MULLER knee-bent 80g 50g  
**04-340** Muller Ligature Forceps

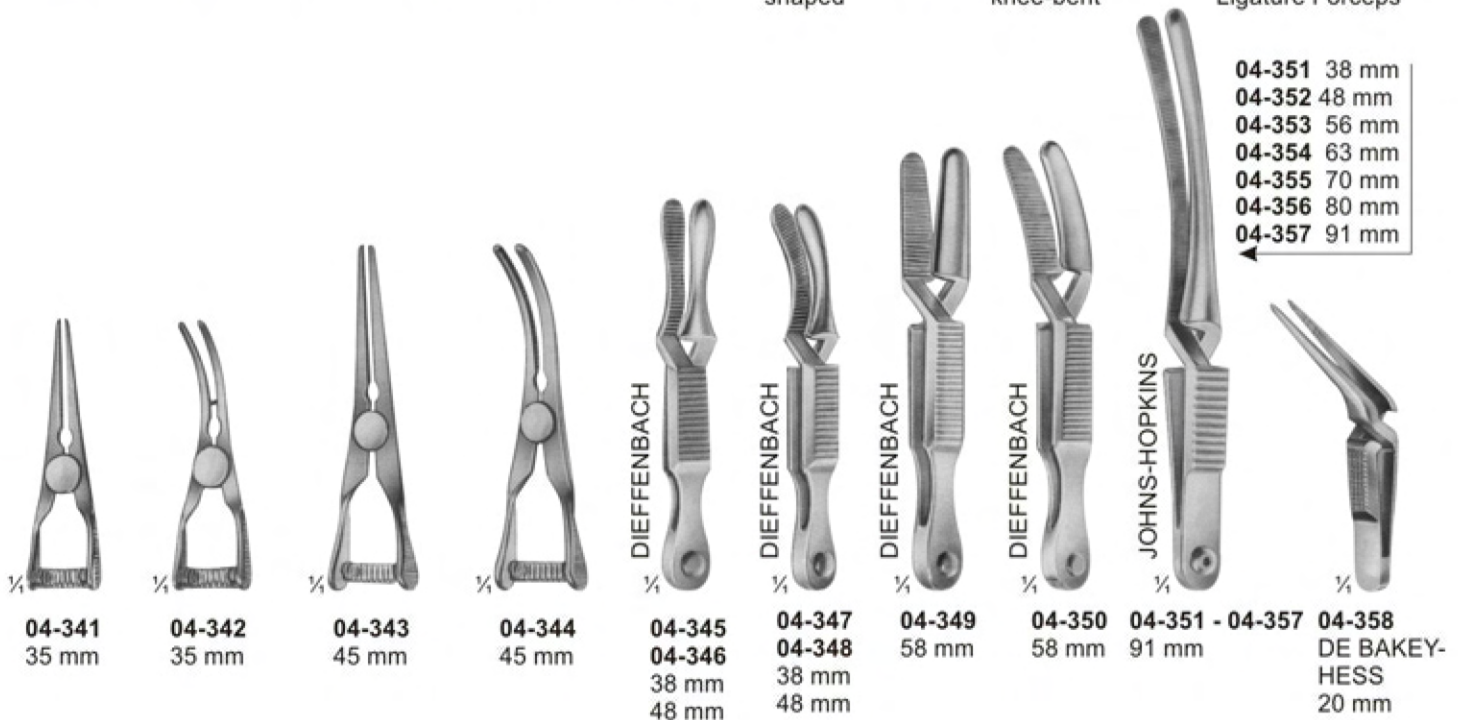

**04-341** 35 mm  
**04-342** 35 mm  
**04-343** 45 mm  
**04-344** 45 mm  
**04-345** DIEFFENBACH 38 mm  
**04-346** DIEFFENBACH 48 mm  
**04-347** DIEFFENBACH 38 mm  
**04-348** DIEFFENBACH 48 mm  
**04-349** DIEFFENBACH 58 mm  
**04-350** DIEFFENBACH 58 mm  
**04-351 - 04-357** JOHNS-HOPKINS 91 mm  
**04-358** DE BAKEY-HESS 20 mm

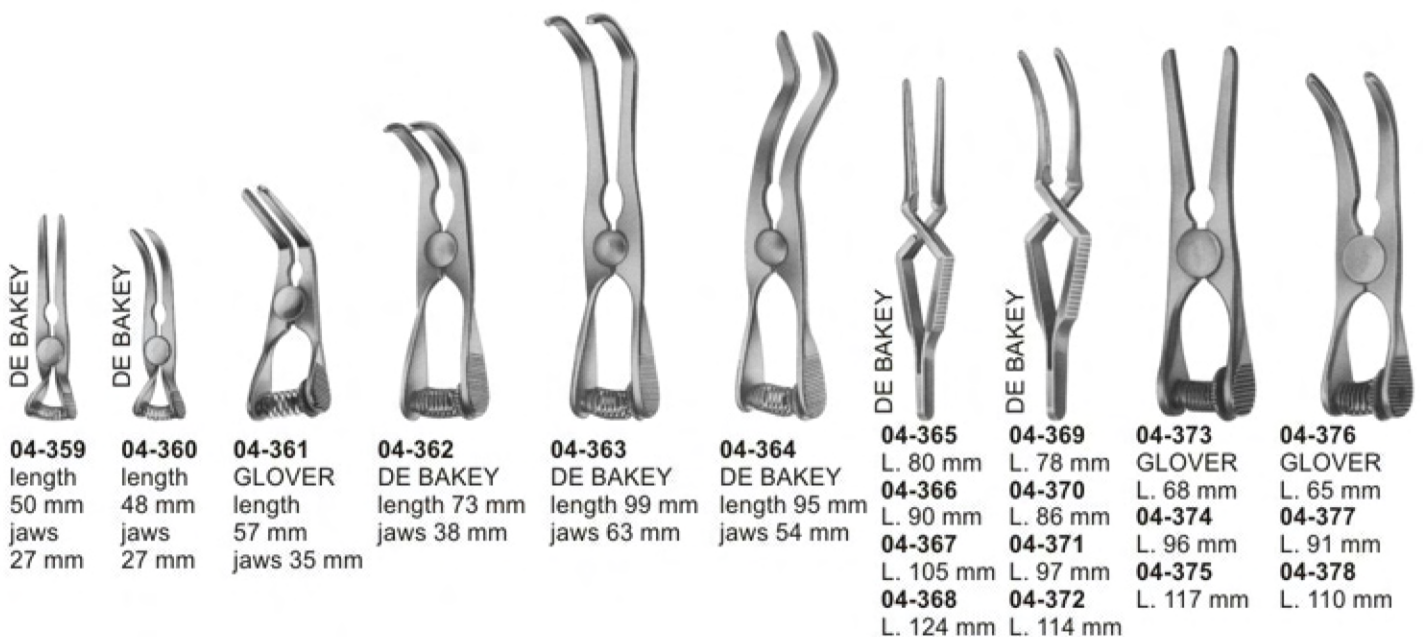

**04-359** DE BAKEY length 50 mm jaws 27 mm  
**04-360** DE BAKEY length 48 mm jaws 27 mm  
**04-361** GLOVER length 57 mm jaws 35 mm  
**04-362** DE BAKEY length 73 mm jaws 38 mm  
**04-363** DE BAKEY length 99 mm jaws 63 mm  
**04-364** DE BAKEY length 95 mm jaws 54 mm  
**04-365** DE BAKEY L. 80 mm  
**04-366** DE BAKEY L. 90 mm  
**04-367** DE BAKEY L. 105 mm  
**04-368** DE BAKEY L. 124 mm  
**04-369** DE BAKEY L. 78 mm  
**04-370** DE BAKEY L. 86 mm  
**04-371** DE BAKEY L. 97 mm  
**04-372** DE BAKEY L. 114 mm  
**04-373** GLOVER L. 68 mm  
**04-374** GLOVER L. 96 mm  
**04-375** GLOVER L. 117 mm  
**04-376** GLOVER L. 65 mm  
**04-377** GLOVER L. 91 mm  
**04-378** GLOVER L. 110 mm

# Delicate Haemostatic Forceps

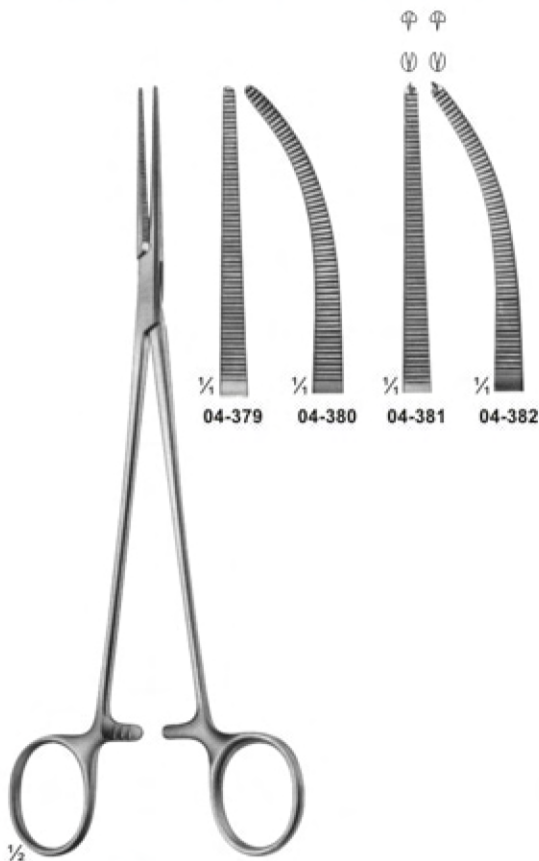

**04-379 - 04-382**  
HALSTED-MOSQUITO  
200 mm

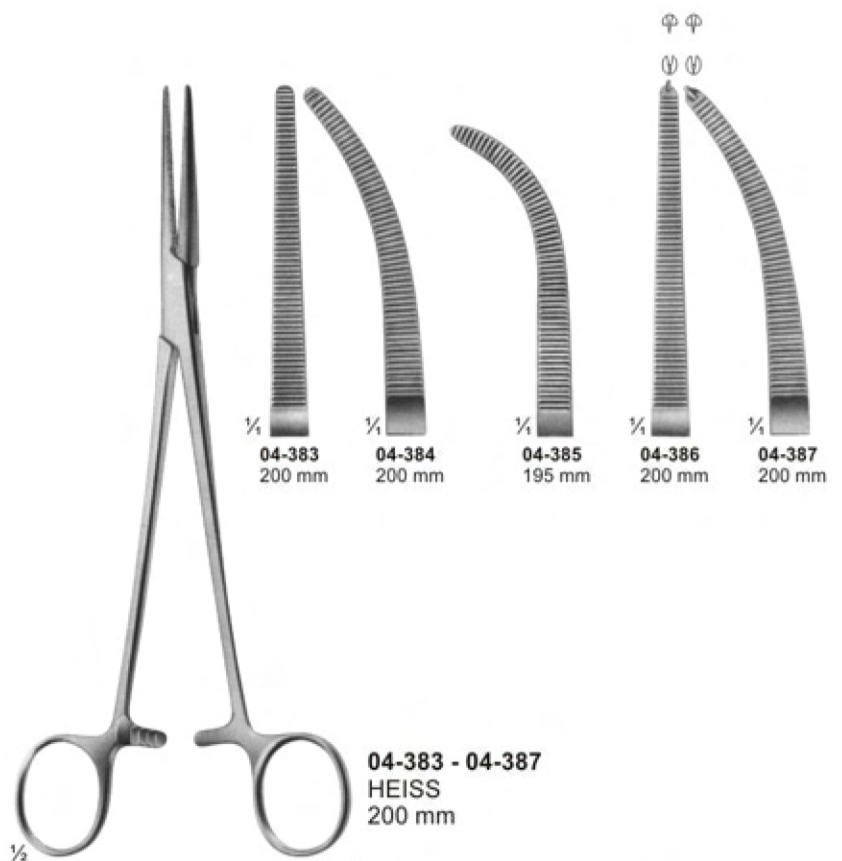

**04-383 - 04-387**  
HEISS  
200 mm



**04-388 - 04-389**  
HALSTED  
215 mm



**04-390 - 04-393**  
BENGOLEA  
245 mm



**04-394**  
CRAFOORD  
245 mm



# Delicate Haemostatic Forceps



**04-395**  
CARREL  
85 mm



**04-396 - 04-399**  
BABY-MOSQUITO  
(HARTMANN)  
100 mm

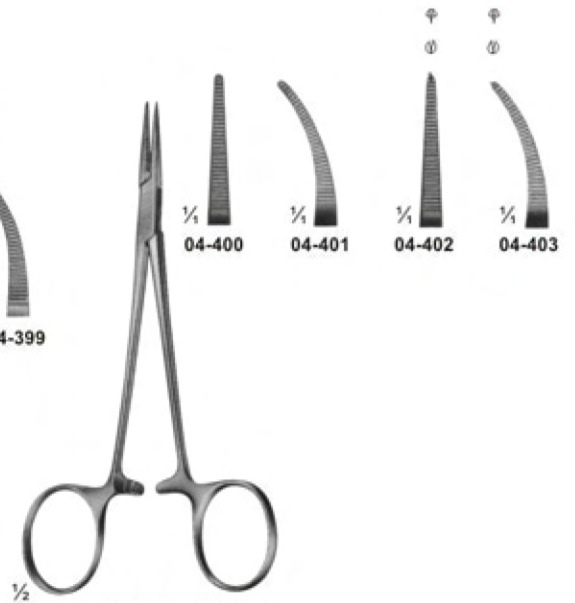

**04-400 - 04-403**  
MICRO-HALSTED  
125 mm

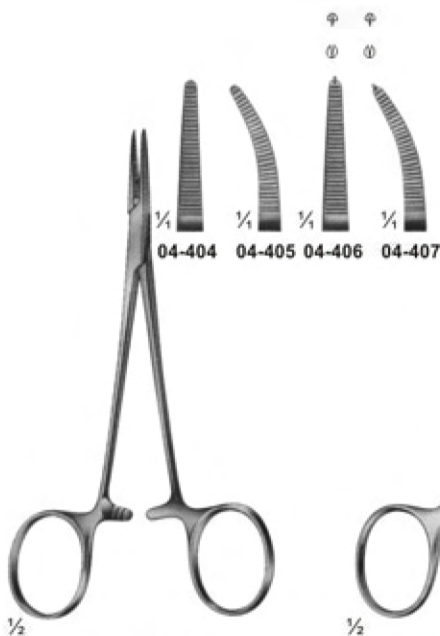

**04-404 - 04-407**  
HALSTED-MOSQUITO  
125 mm

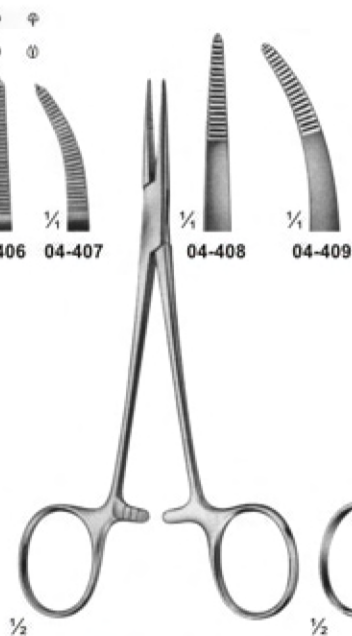

**04-408 - 04-409**  
PROVIDENCE-HOSPITAL  
140 mm

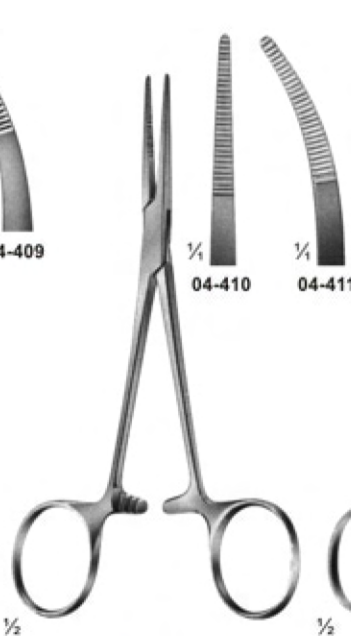

**04-410 - 04-411**  
KELLY  
140 mm

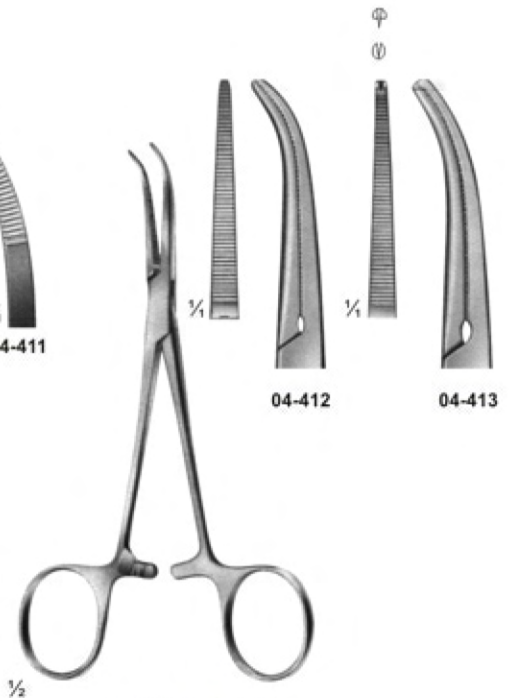

**04-412 - 04-413**  
DANDY  
Curved sideways  
140 mm



# Delicate Haemostatic Forceps

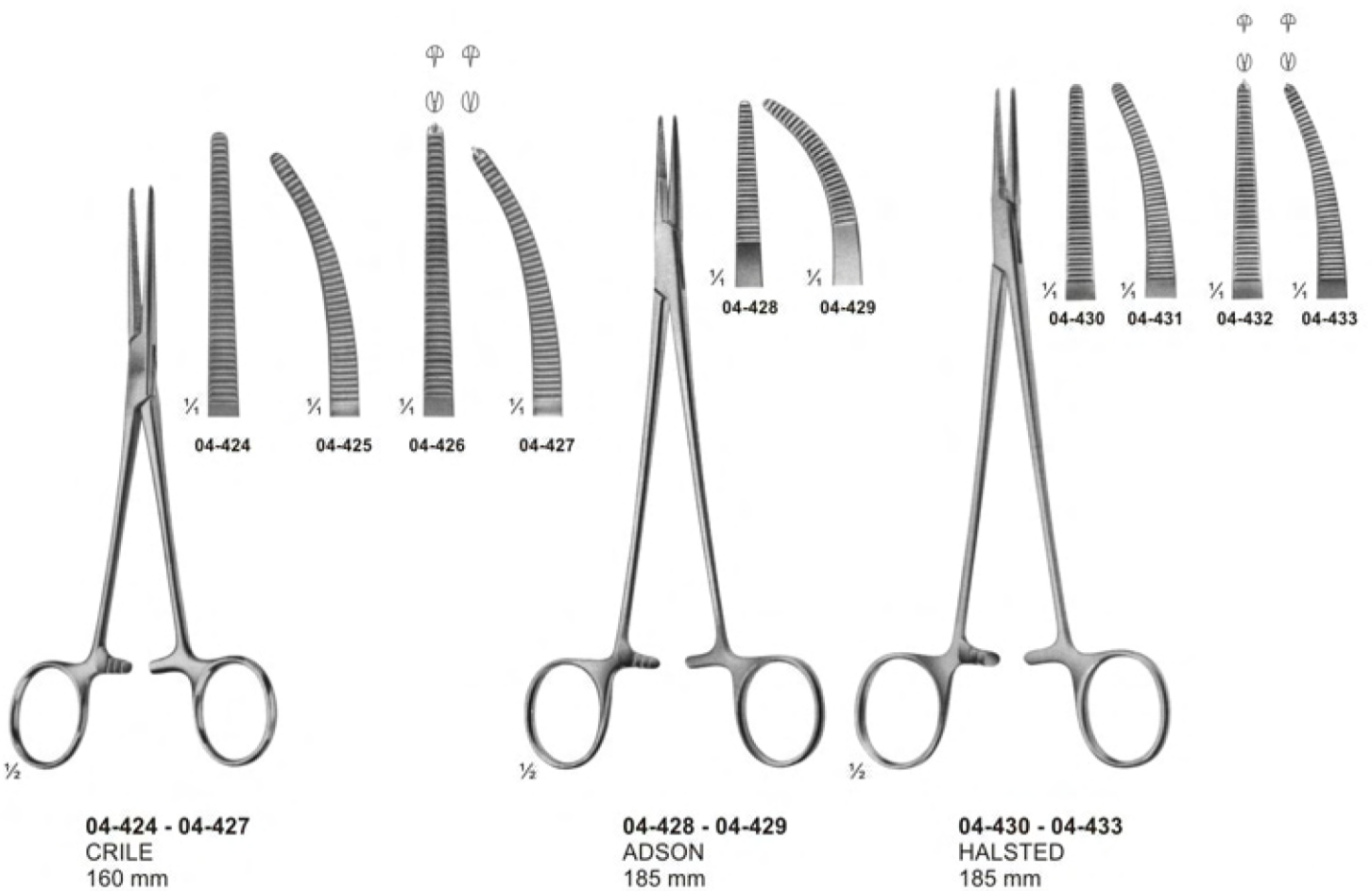
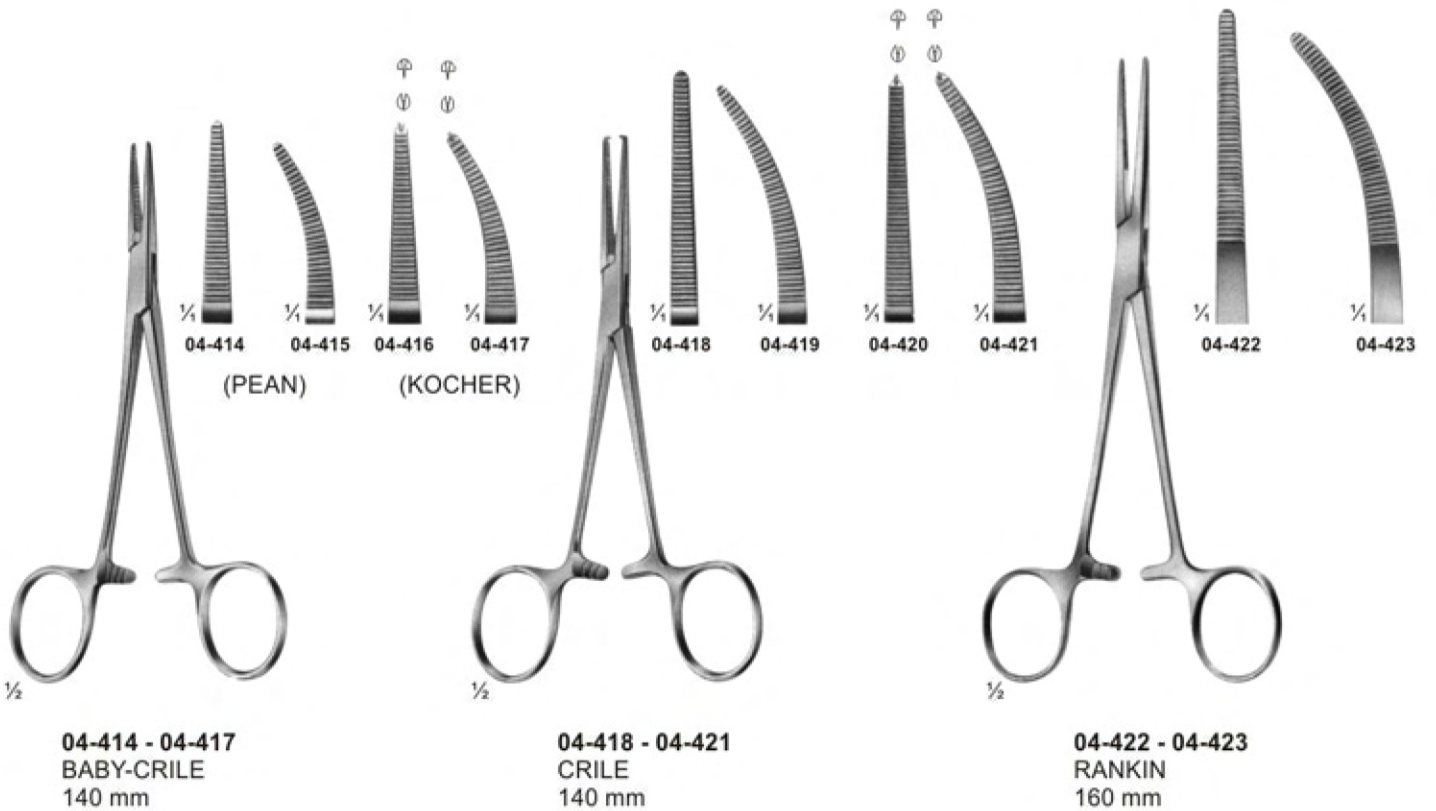

# Haemostatic Forceps

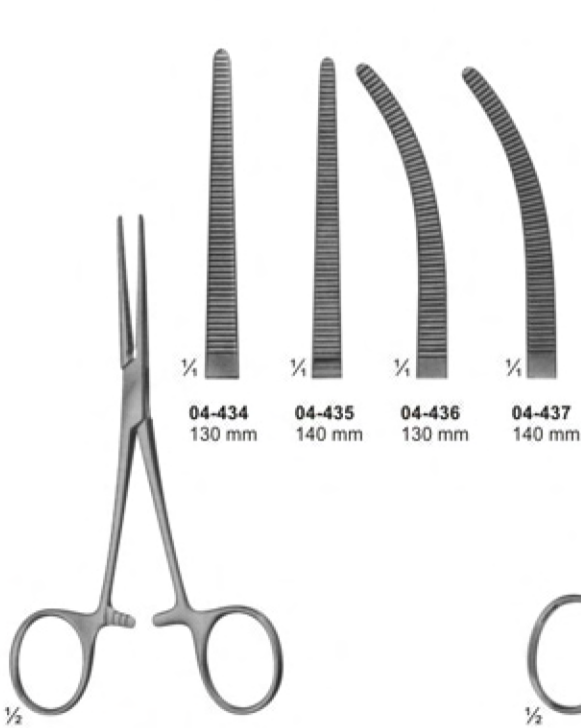

04-434 130 mm  
04-435 140 mm  
04-436 130 mm  
04-437 140 mm

04-434 - 04-437  
PEAN  
Slender type

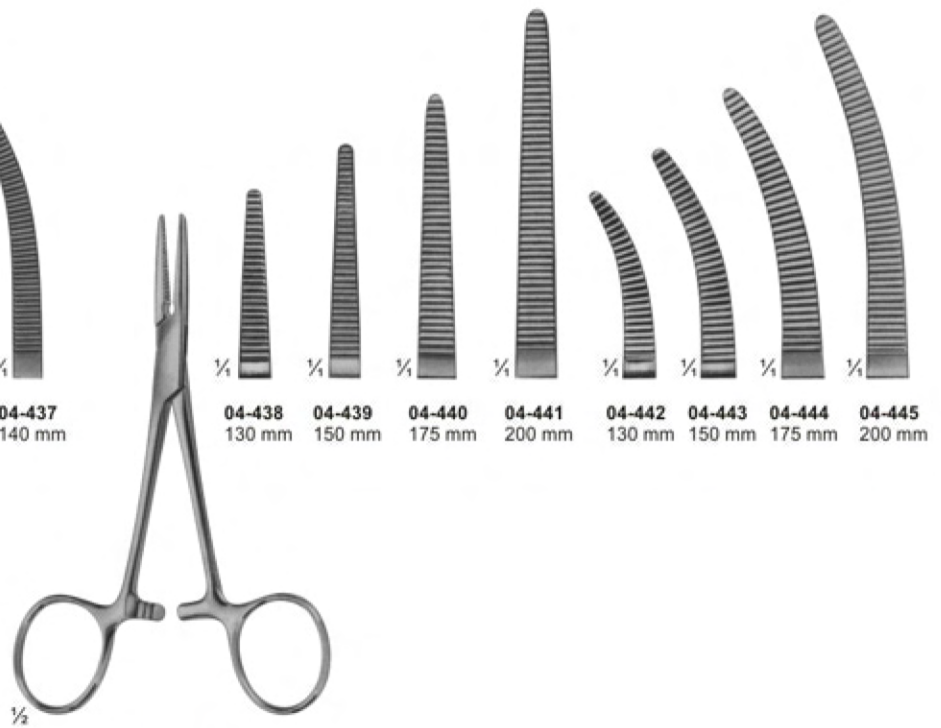

04-438 130 mm  
04-439 150 mm  
04-440 175 mm  
04-441 200 mm  
04-442 130 mm  
04-443 150 mm  
04-444 175 mm  
04-445 200 mm

04-438 - 04-445  
SPENCER-WELLS  
Slender type

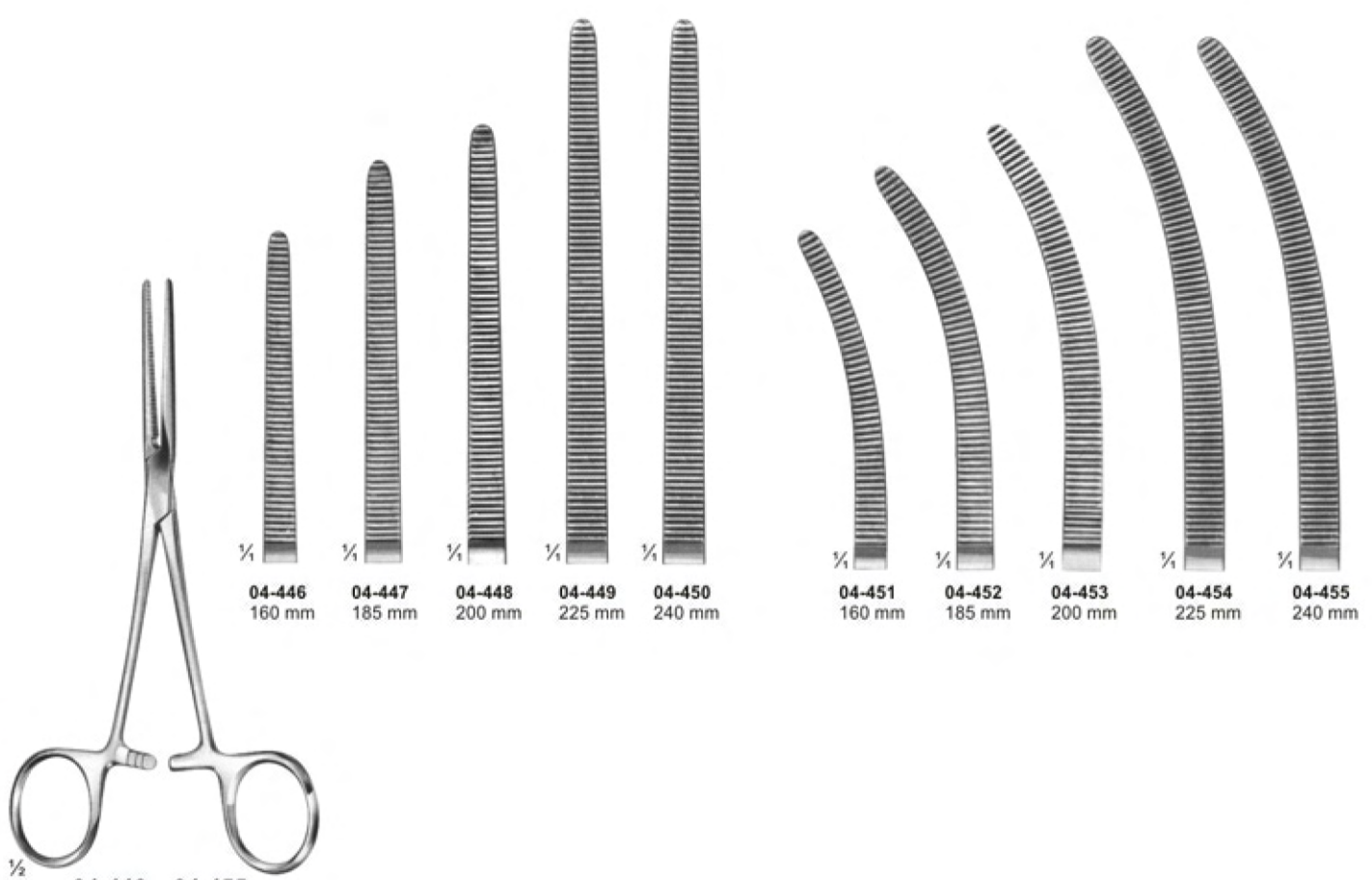

04-446 160 mm  
04-447 185 mm  
04-448 200 mm  
04-449 225 mm  
04-450 240 mm  
04-451 160 mm  
04-452 185 mm  
04-453 200 mm  
04-454 225 mm  
04-455 240 mm

04-446 - 04-455  
ROCHESTER-PEAN

# Haemostatic Forceps



**04-456 - 04-461**  
PEAN

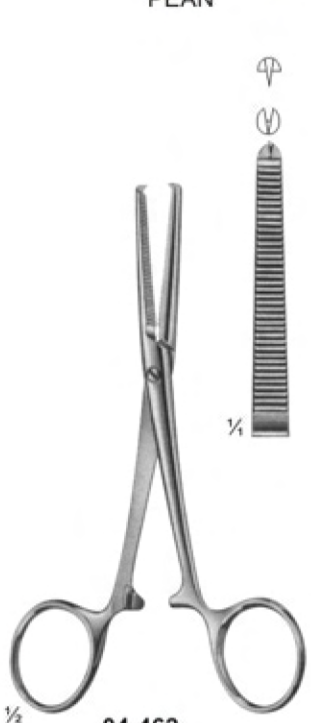
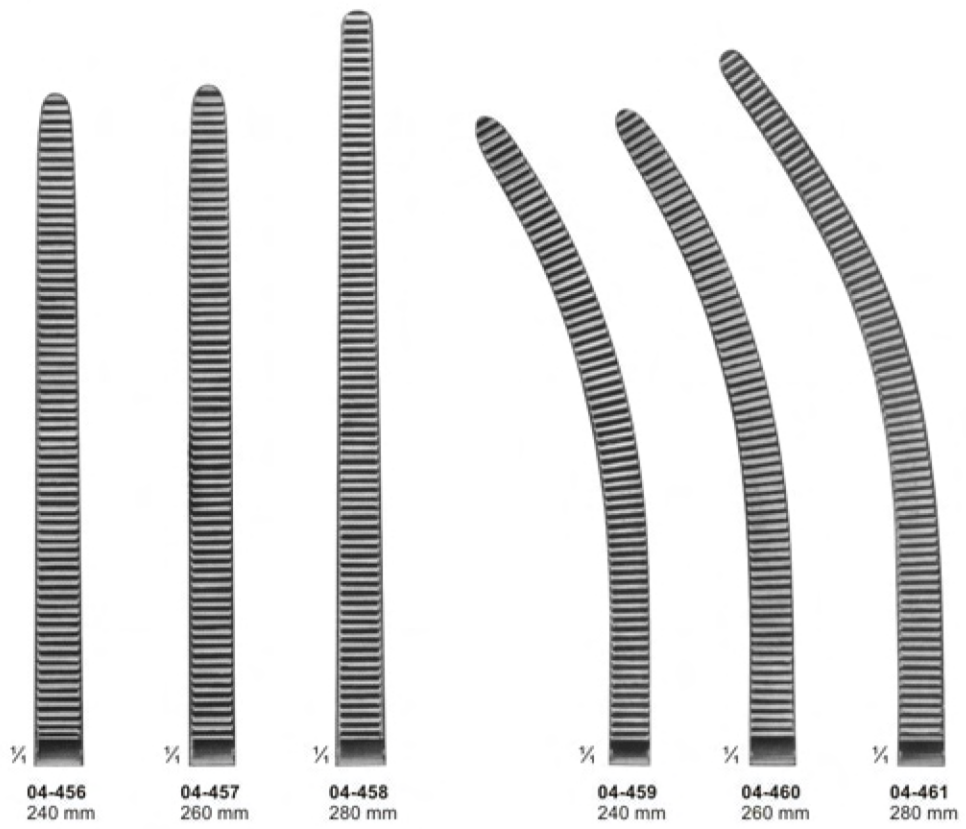

**04-462**  
KOCHER  
Strong Pattern  
145 mm

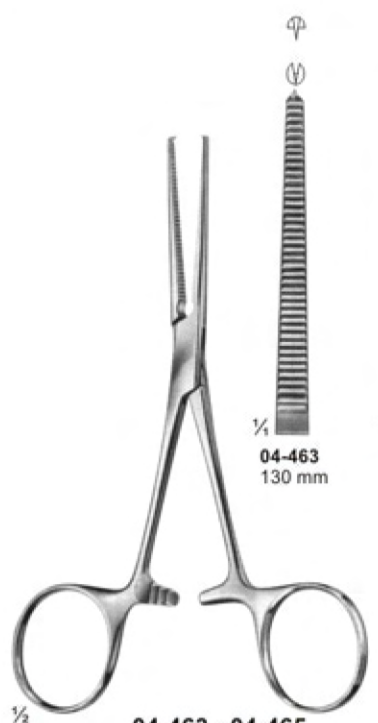

**04-463 - 04-465**  
KOCHER

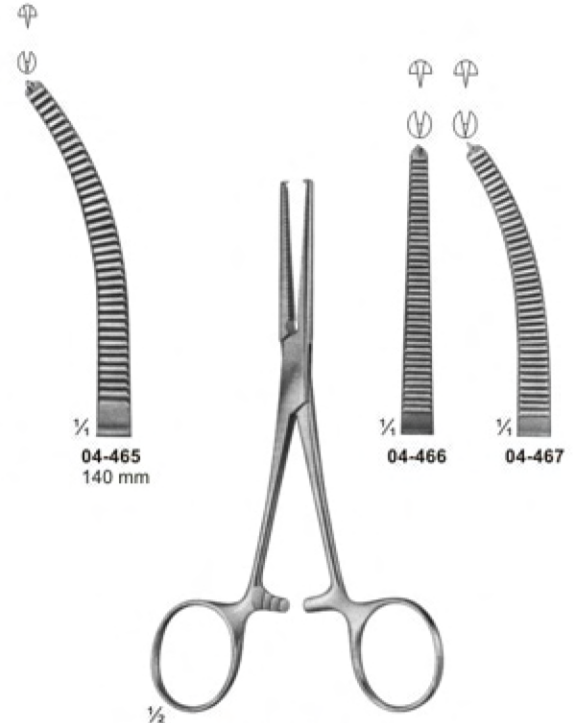

**04-466 - 04-467**  
ROCHESTER-OGHSNER  
140 mm

# Haemostatic Forceps

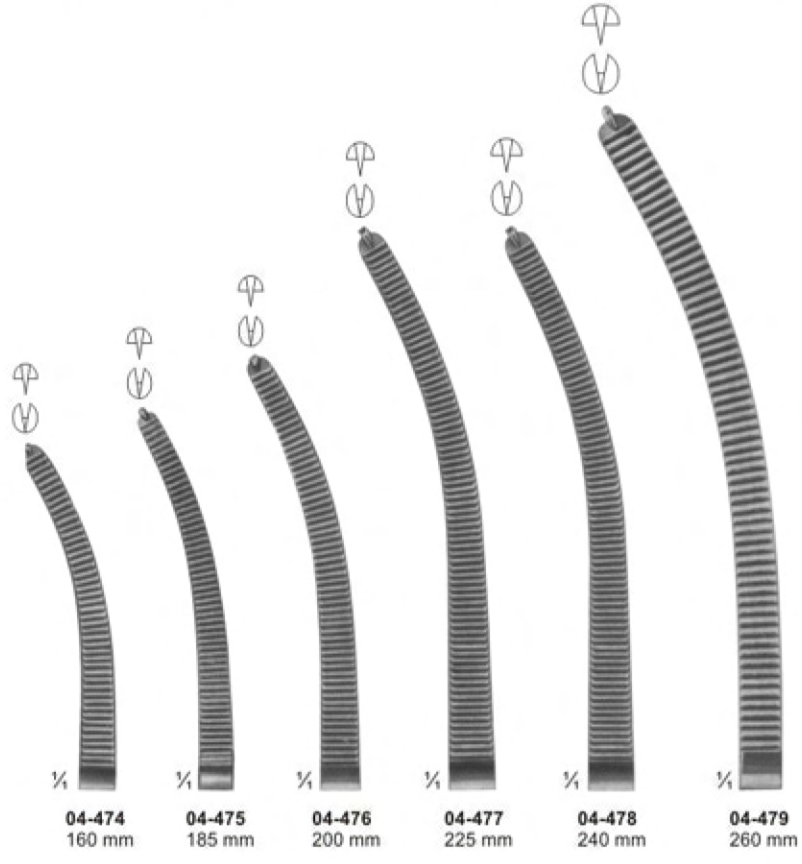
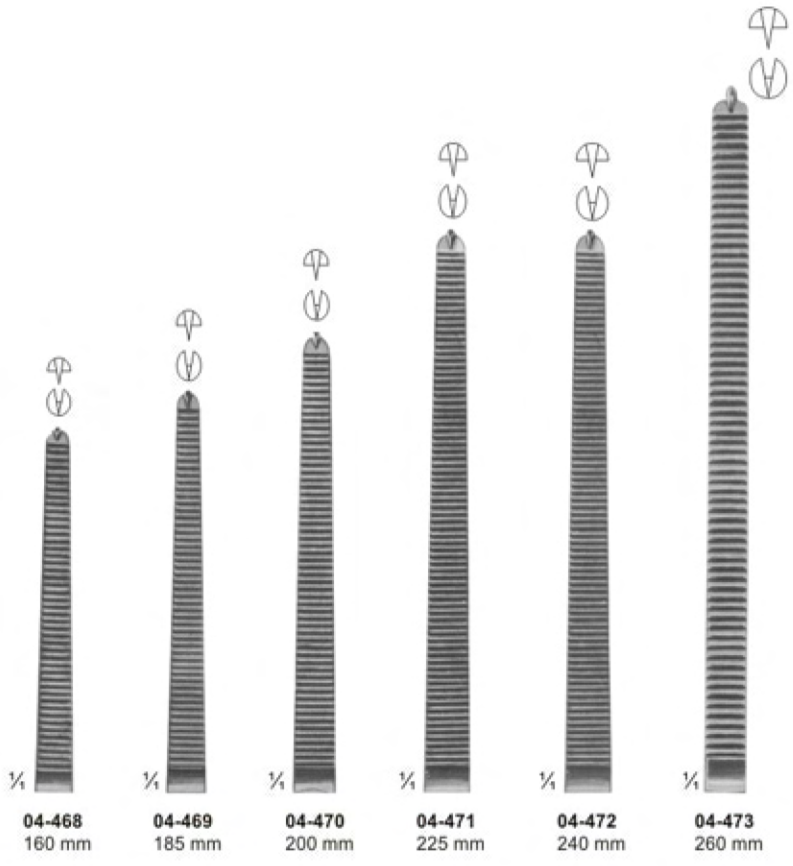

**04-468 - 04-479**  
KOCHER-OCHSNER



# Haemostatic Forceps

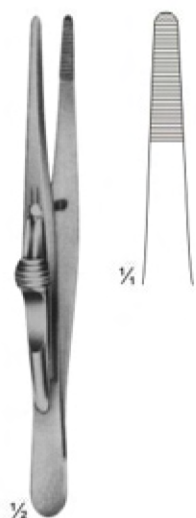

**04-480**  
FRICKE  
Artery forceps  
130 mm

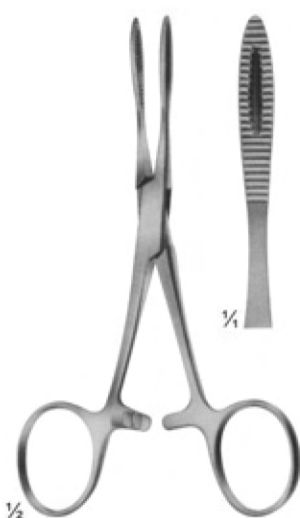

**04-481**  
KRONLEIN  
130 mm

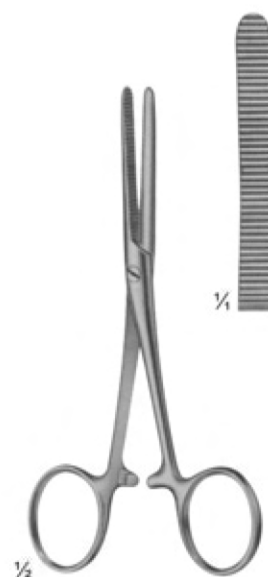

**04-482**  
PEAN  
125 mm



**04-483 - 04-484**  
PEAN

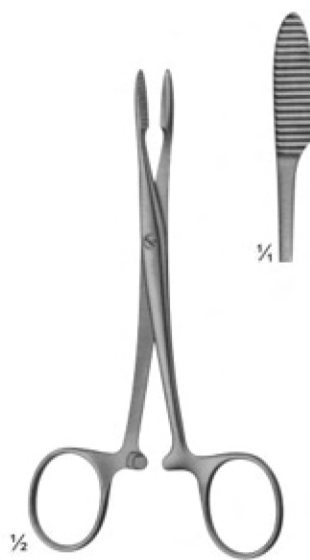

**04-485**  
PEAN  
125 mm

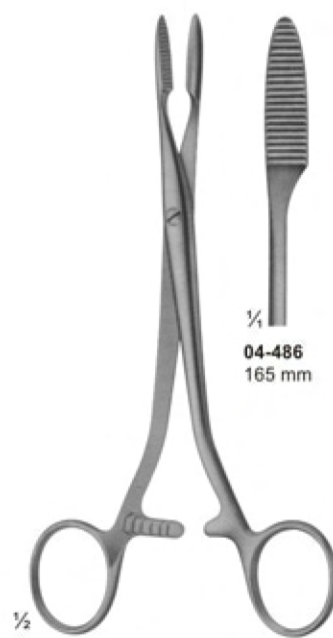

**04-486 - 04-487**  
PEAN



# Haemostatic Forceps, Special Pattern, Tonsil Forceps

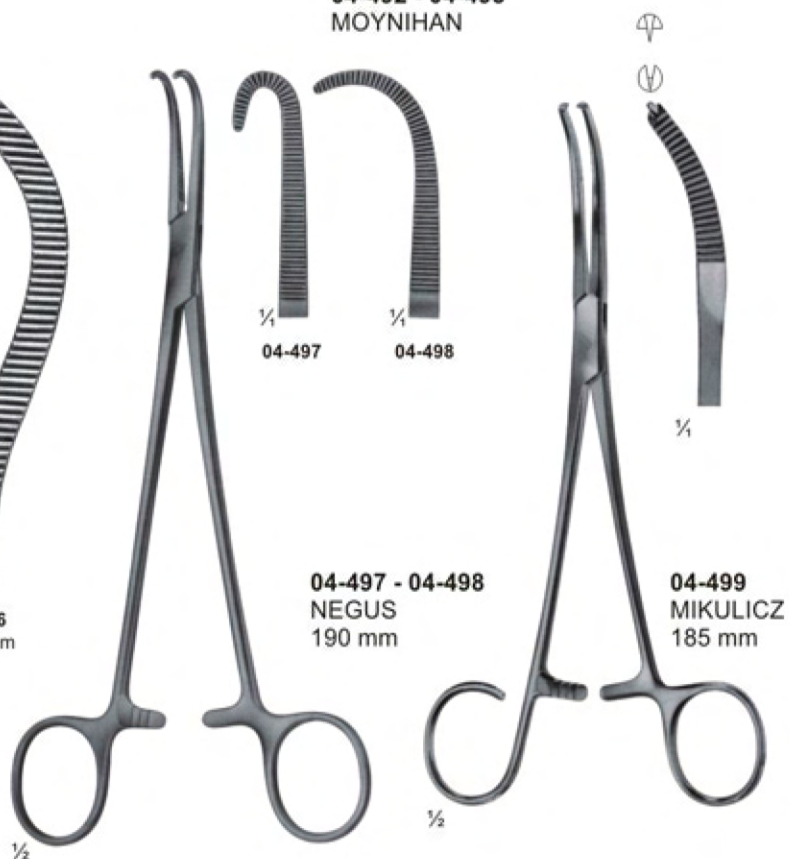

# Dissecting- and Ligature Forceps



**04-500**  
MIXTER-O'SHAUGNESSY  
190 mm

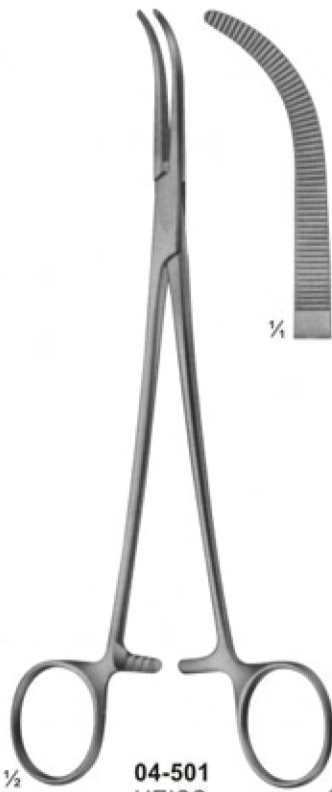

**04-501**  
HEISS  
195 mm

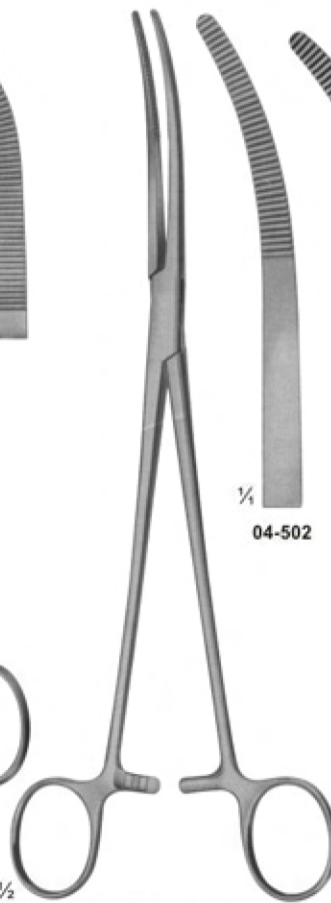

**04-502 - 04-506**  
RUMEL  
240 mm

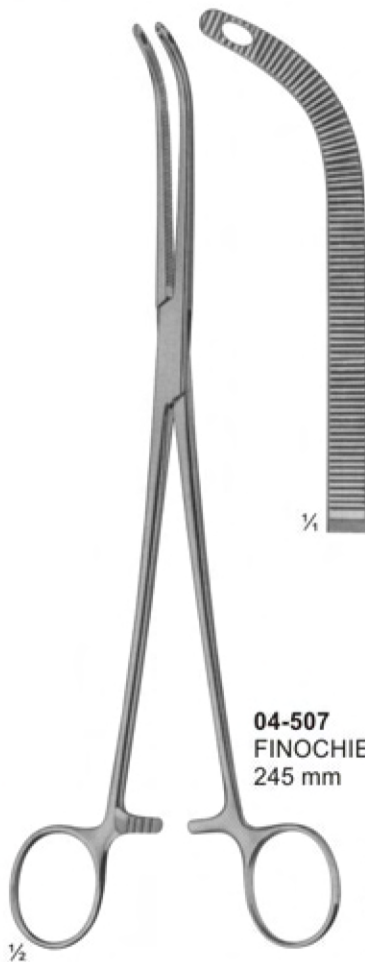
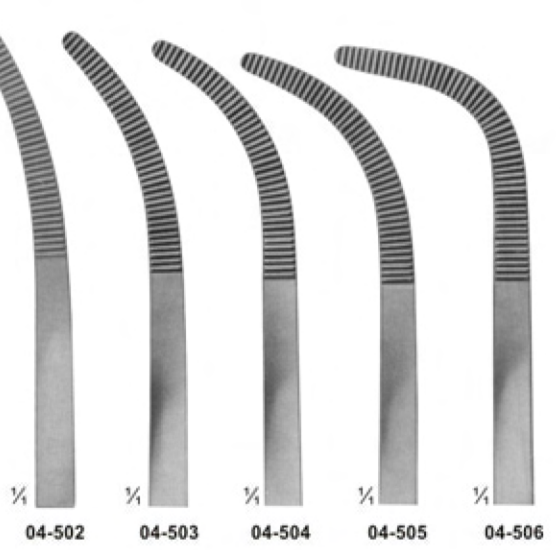

**04-507**  
FINOCHIETTO  
245 mm

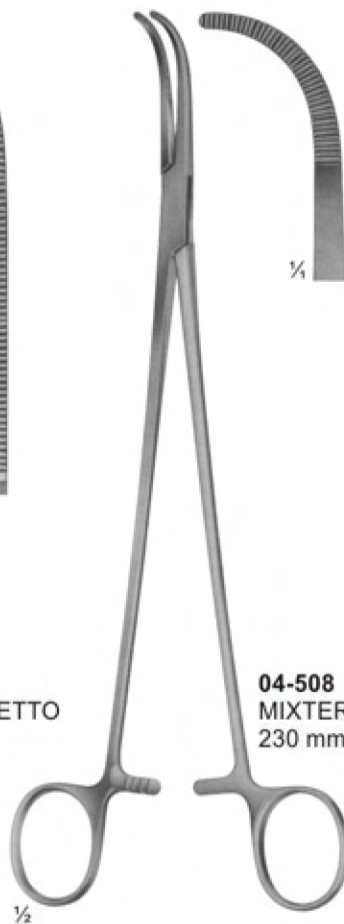

**04-508**  
MIXTER  
230 mm



**04-509**  
LAWRENCE  
270 mm

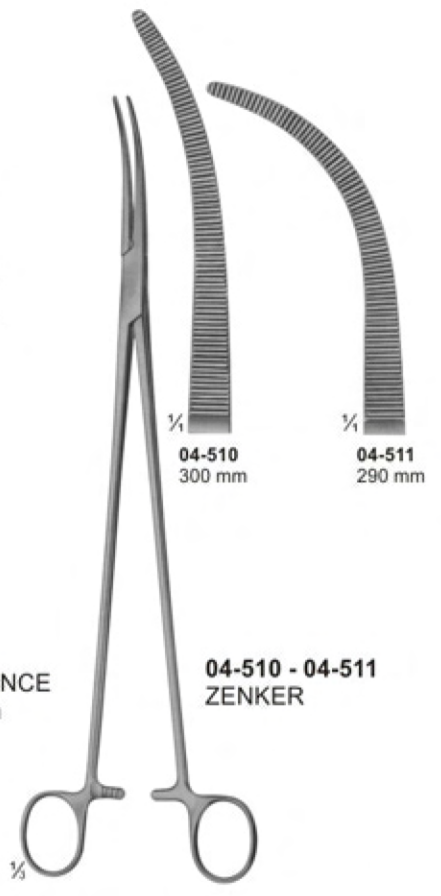

**04-510 - 04-511**  
ZENKER

# Hysterectomy Forceps, Vaginal Clamps and Compression Forceps



**04-512**  
**WERTHEIM**  
 Hysterectomy forceps  
 255 mm



**04-513**  
**WERTHEIM**  
 Parametrium clamp  
 260 mm



**04-514 - 04-516**  
**DICK**



**04-514**  
 255 mm

**04-515**  
 265 mm

**04-516**  
 275 mm



# Hysterectomy Forceps, Vaginal Clamps and Compression Forceps

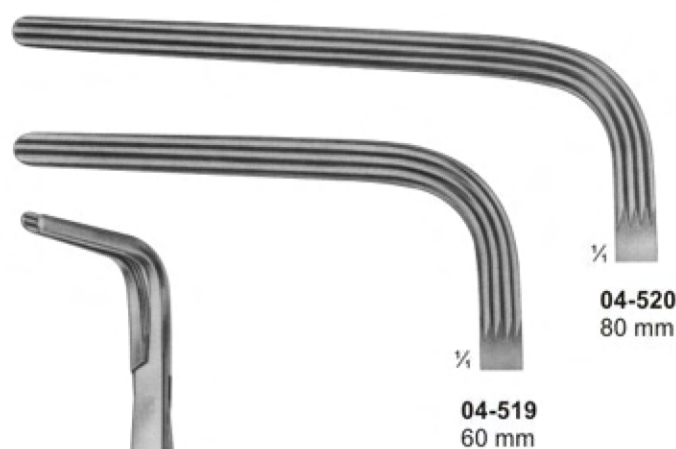
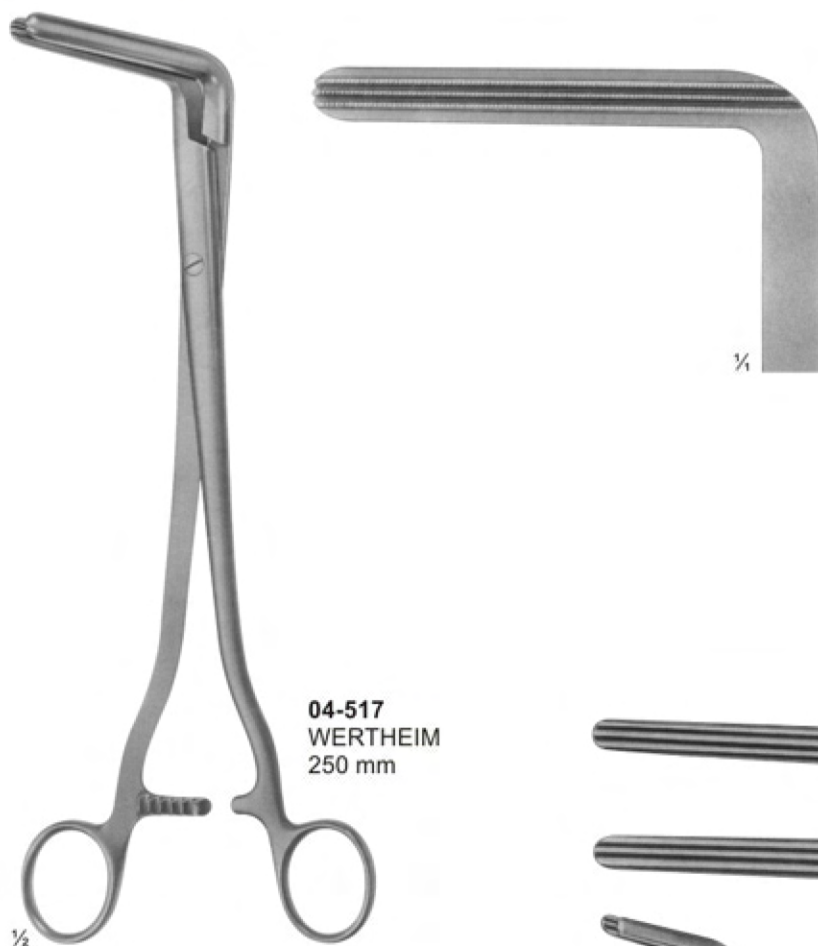

## Needle Holders for micro surgery



**05-101**  
ROHRSCHEIDER  
with copper inserts  
100 mm



**05-102**  
KALT  
with catch  
135 mm



**05-103**  
ARRUGA  
with catch  
135 mm



**05-104 - 105**  
CASTROVIEJO  
with catch  
145 mm



**05-106 - 107**  
without Catch  
160 mm



**05-108 - 109**  
without catch  
185 mm



**05-109**



**05-110 - 111**  
JACOBSON  
without catch  
185 mm

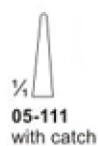

**05-111**  
with catch



**05-112**  
without catch  
195 mm



**05-113 - 114**  
YASARGIL  
with catch  
200 mm

# Needle Holders

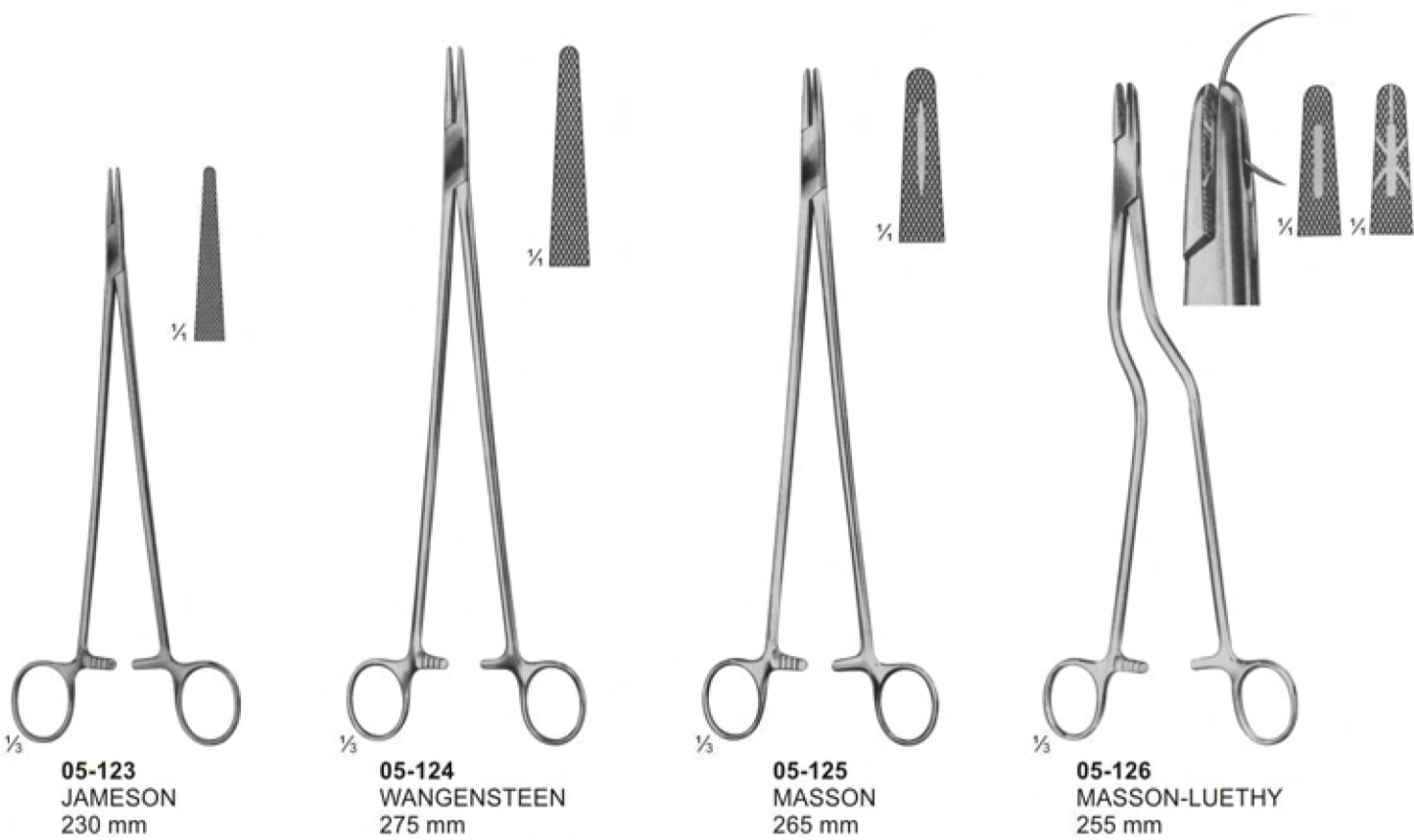

# Needle Holders

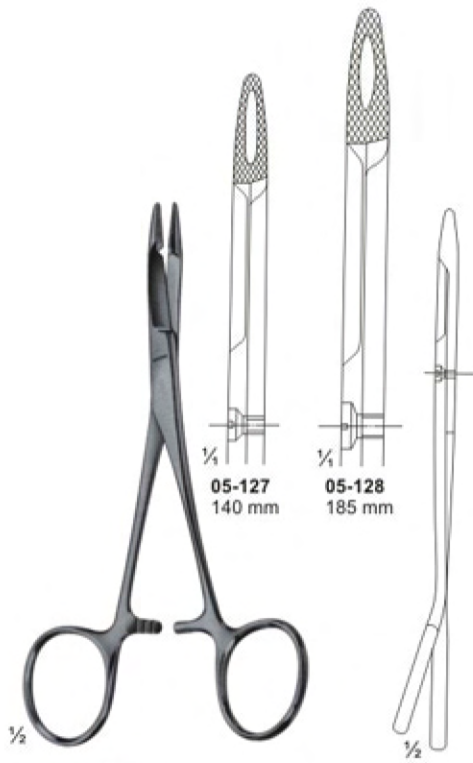

**05-127 - 128**  
**HEGAR-OLSEN**  
255 mm



**05-129**  
**GILLIES**  
150 mm



**05-130**  
**GILLIES**  
160 mm

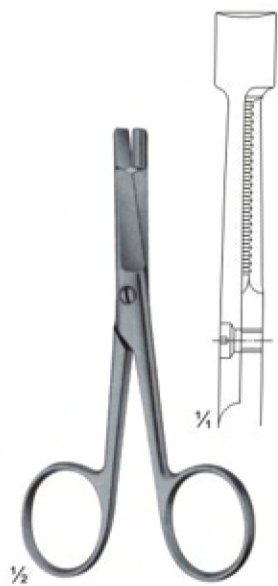

**05-131**  
**EISELSBERG**  
115 mm

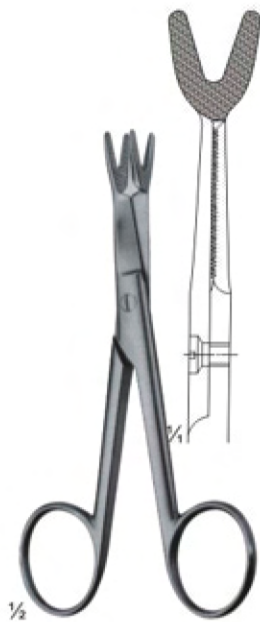

**05-132**  
**SCHOEMAKER-LOTH**  
125 mm



**05-133**  
**CRILE**  
150 mm



**05-134**  
**TOENNIS**  
Elastic pattern for dura-or  
intestinal suture. 180 mm



# Needle Holders

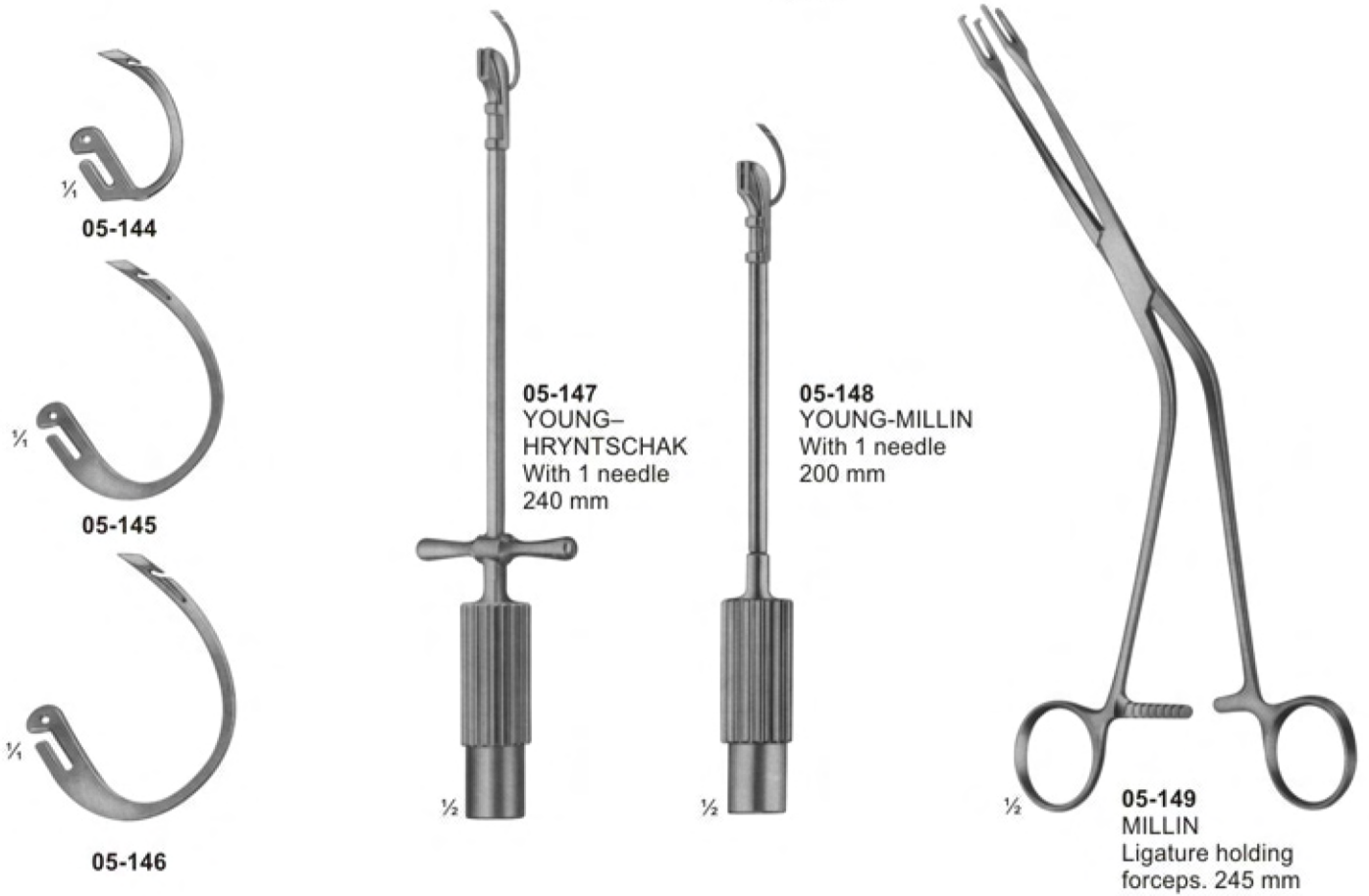
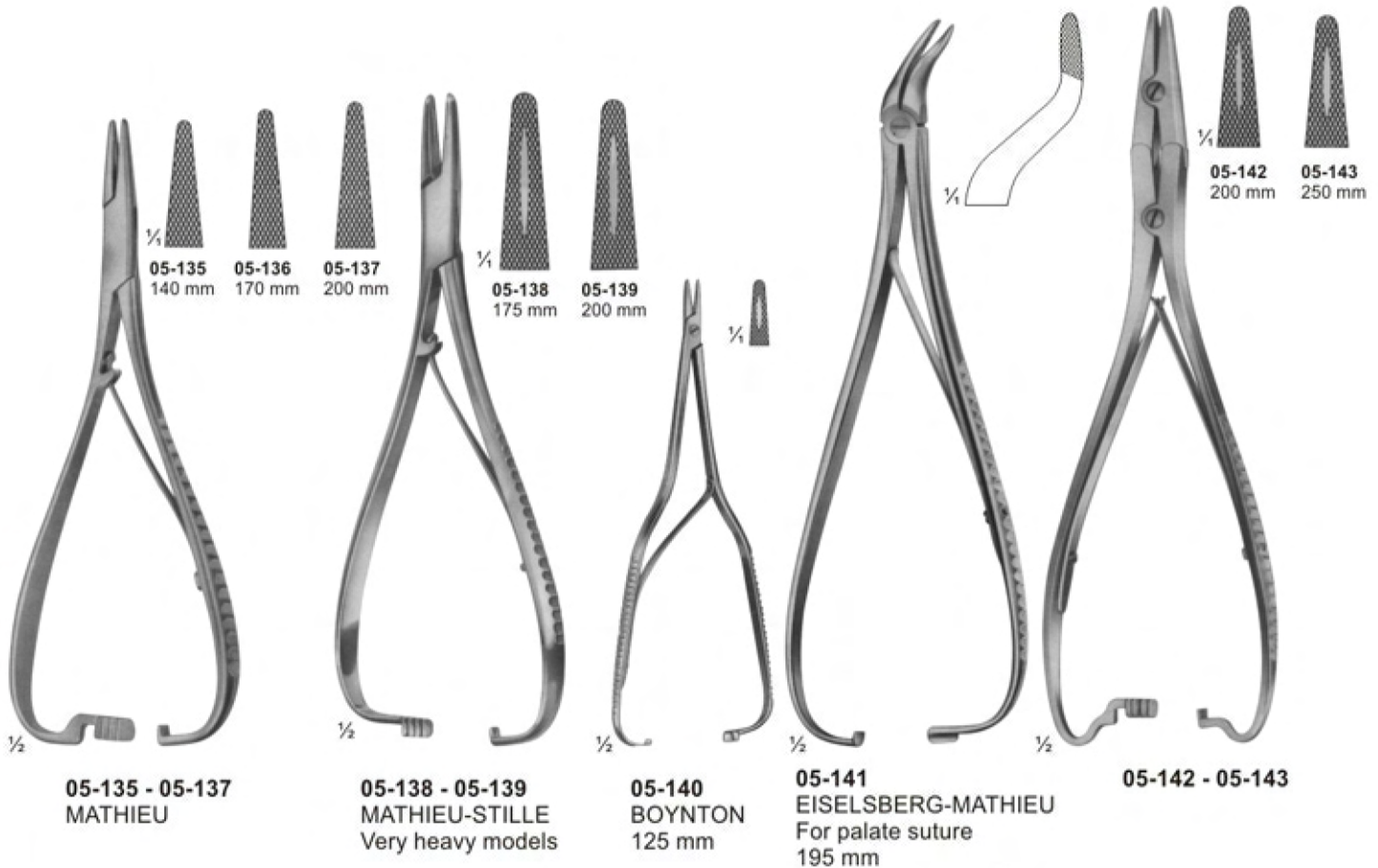

# Suture Instruments - Reverdin Needles

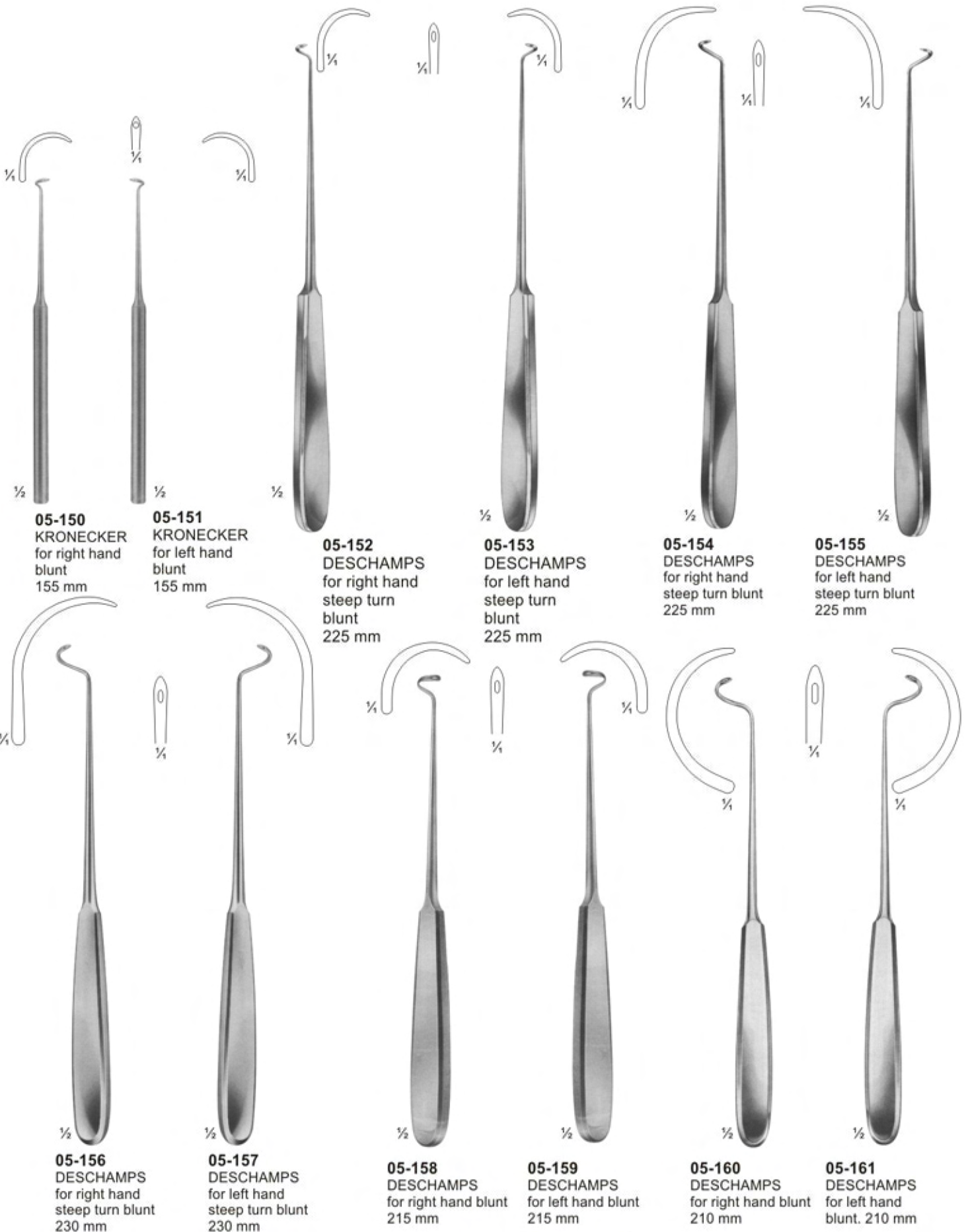

# Probes



05-162 130 mm  
05-163 145 mm  
05-164 160 mm  
Directors

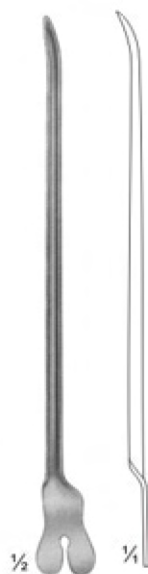

05-165  
DOYEN  
145 mm  
Directors

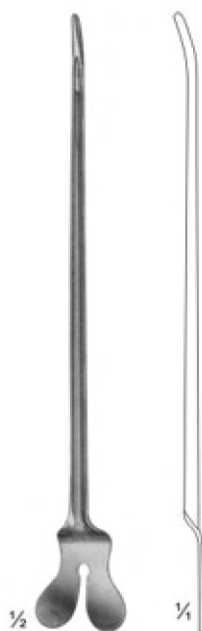

05-166  
NELATON  
160 mm  
Directors

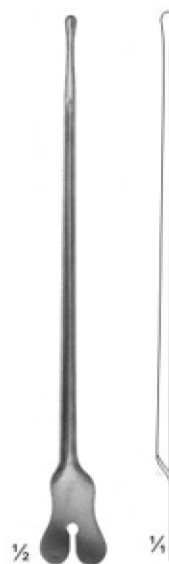

05-167  
Director with tip  
Diam. Of tip 3,3 mm  
140 mm

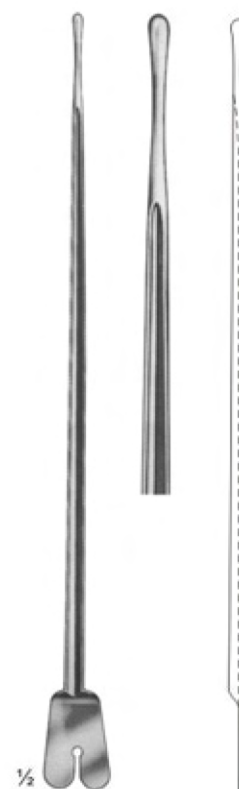

05-168  
BRODIE  
Director with tip,  
Diam. Of tip 3,5 mm  
200 mm

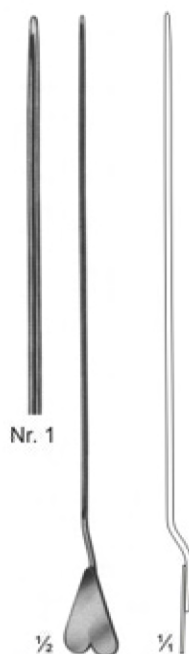

05-169  
LOCKHART-MUMMERY  
165 mm

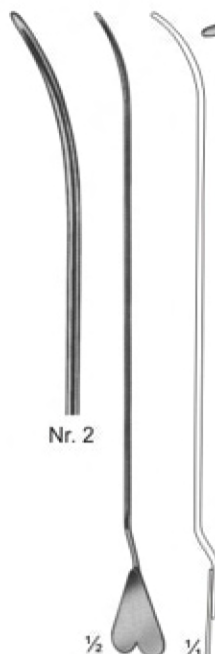

05-170  
LOCKHART-MUMMERY  
165 mm

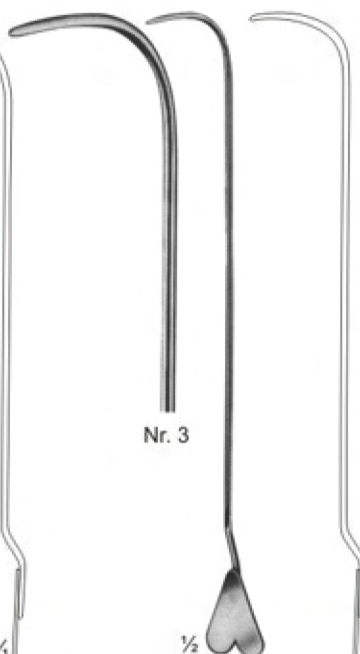

05-171  
LOCKHART-MUMMERY  
165 mm

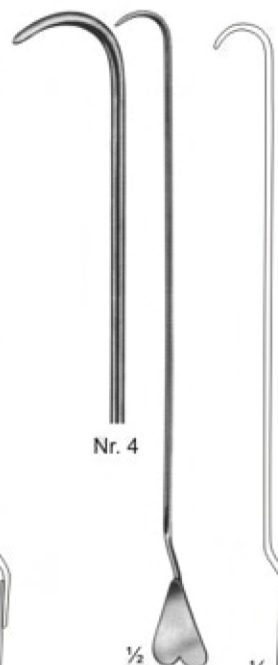

05-172  
LOCKHART-MUMMERY  
165 mm



05-173  
Director with wire  
loop, malleable  
190 mm

# Probes



05-174  
2,5 mm  
05-175  
2,5 mm  
05-176  
3,0 mm

05-174 145 mm  
05-175 160 mm  
05-176 200 mm  
Probes with eye



1,5 mm

05-177  
Myrtle leaf probe  
145 mm



2,0 mm

05-178 130 mm  
05-179 145 mm  
05-180 160 mm  
05-181 180 mm  
05-182 200 mm



05-183  
Probes



05-184  $\frac{1}{2}$   
Double ended probe,  
malleable, diam. of tips  
3 mm with hole  
190 mm



05-185  
Double ended probes,  
tin, malleable,  
diam. of tips  
3,5 mm with hole  
250 mm, 300 mm



05-186  $\frac{1}{4}$   
Double ended probes,  
tin, malleable,  
diam. of tips 4 mm  
400 mm



$\frac{1}{8}$   $\varnothing$  tip  
05-187 1,5 mm  
05-188 2,0 mm  
05-189 2,5 mm  
300 mm



## Suturing Instrument Set, Pocket Instrument Set



### 05-190

Suturing instruments set, in metal case consisting of: Scissors, curved, sharp/sharp, 115mm  
25 MICHEL clip, 16 x 3mm  
1 Delicate tissue forceps, 130mm  
1 Scalpel, bellied  
1 MATHIEU needle holder, 140mm  
1 Perforated metal case, stainless containing:  
1 Suture needle  
1 item 1 item



### 05-191

Pocket instrument set, in metal case consisting of:

#### Bottom tray

1 MATHIEU needle holder, 140mm  
1 MICHEL clip forceps, combined  
1 Myrtle leaf probe, 130mm  
1 Sharp double curette  
1 Skin hook  
1 Detachable scalpel handle, no.4  
1 Perforated metal case, containing  
6 Scalpel blades  
1 Perforated metal case, stainless, containing  
1 Suture needle  
1 item  
1 item



#### Top tray

1 Tissue forceps, 130mm  
1 KOCHER haemostatic forceps, 130mm  
1 Straight surgical scissors, 130mm  
1 Dissecting forceps, 130mm  
1 FEILCHENFELD splinter forceps, 115mm  
25 MICHEL clip, 16 x 3mm  
1 Flacon of suture skin, sterile in alcohol



### 05-192

Pocket instrument set, in metal case consisting of:

#### Bottom tray

1 MAYO-HEGER needle holder, 150mm  
1 MICHEL clip forceps, combined  
1 Myrtle leaf probe, 130mm  
1 Sharp double curette  
1 Skin hook  
1 Detachable scalpel handle, no. 4  
1 Perforated metal case, consisting  
6 Scalpel blades  
1 Perforated metal case, stainless, consisting:  
1 Suture needle  
1 item, & 1 item



#### Top tray

1 Tissue forceps, 130mm  
1 CRILE haemostatic forceps, 140mm  
1 Straight surgical scissors, 130mm  
1 Dissecting forceps, 130mm  
1 FEILCHENFELD splinter forceps, 115mm  
25 MICHEL clip, 16 x 3mm  
1 Flacon of suture silk, sterile in alcohol

## Fine Wound Retractors (Dura- and Skin Retractors)

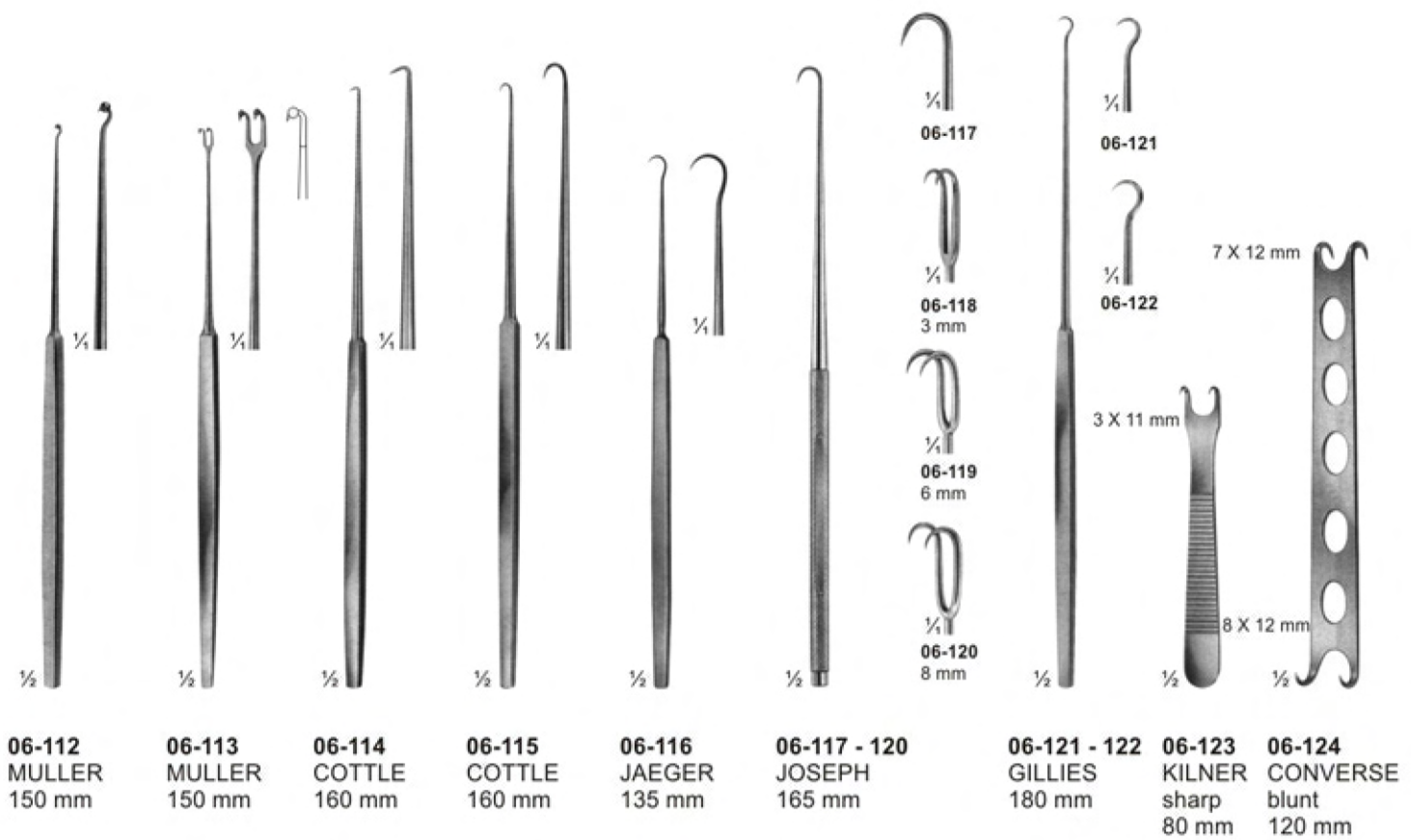
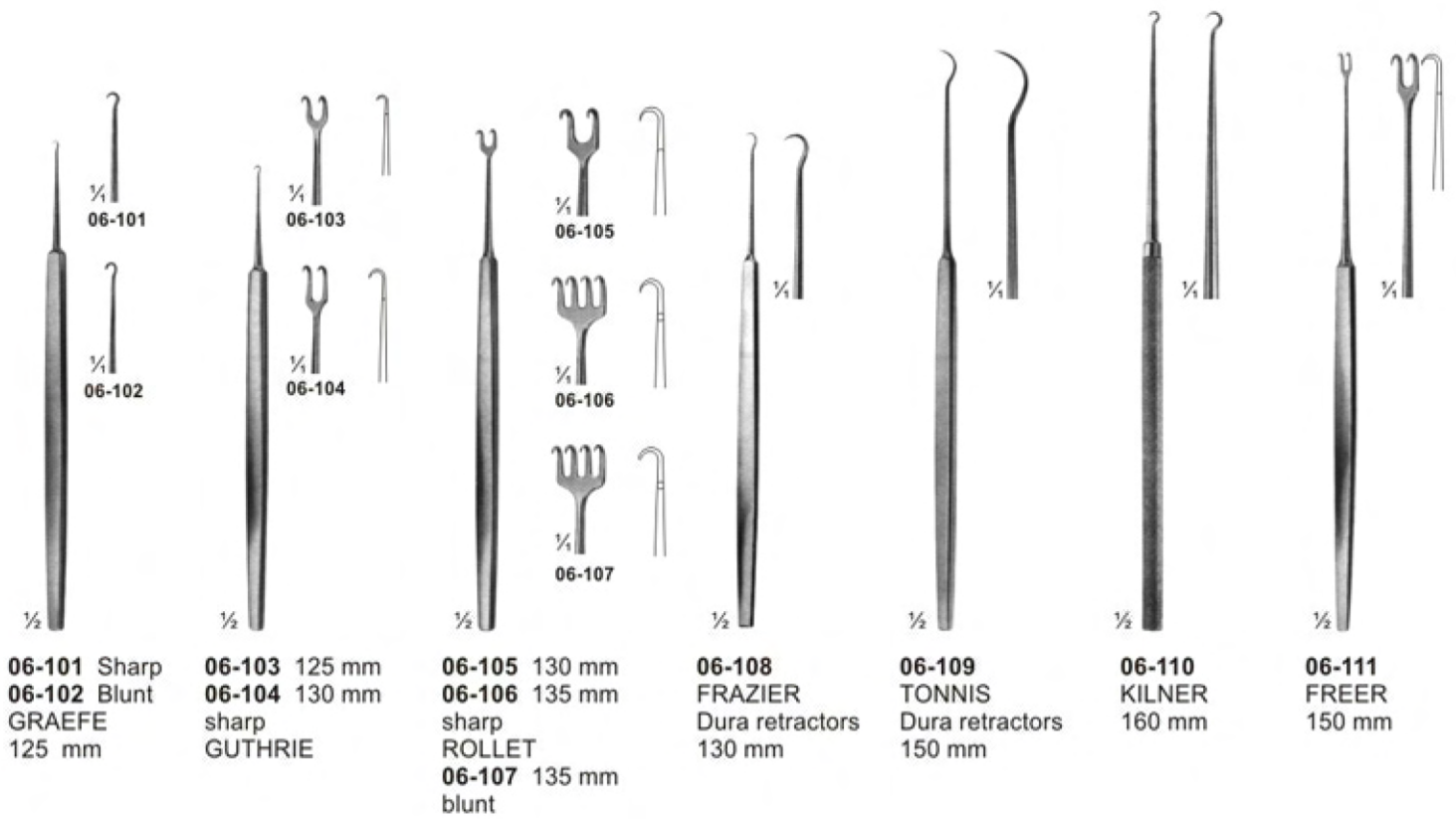

## Retractors With treangle handle

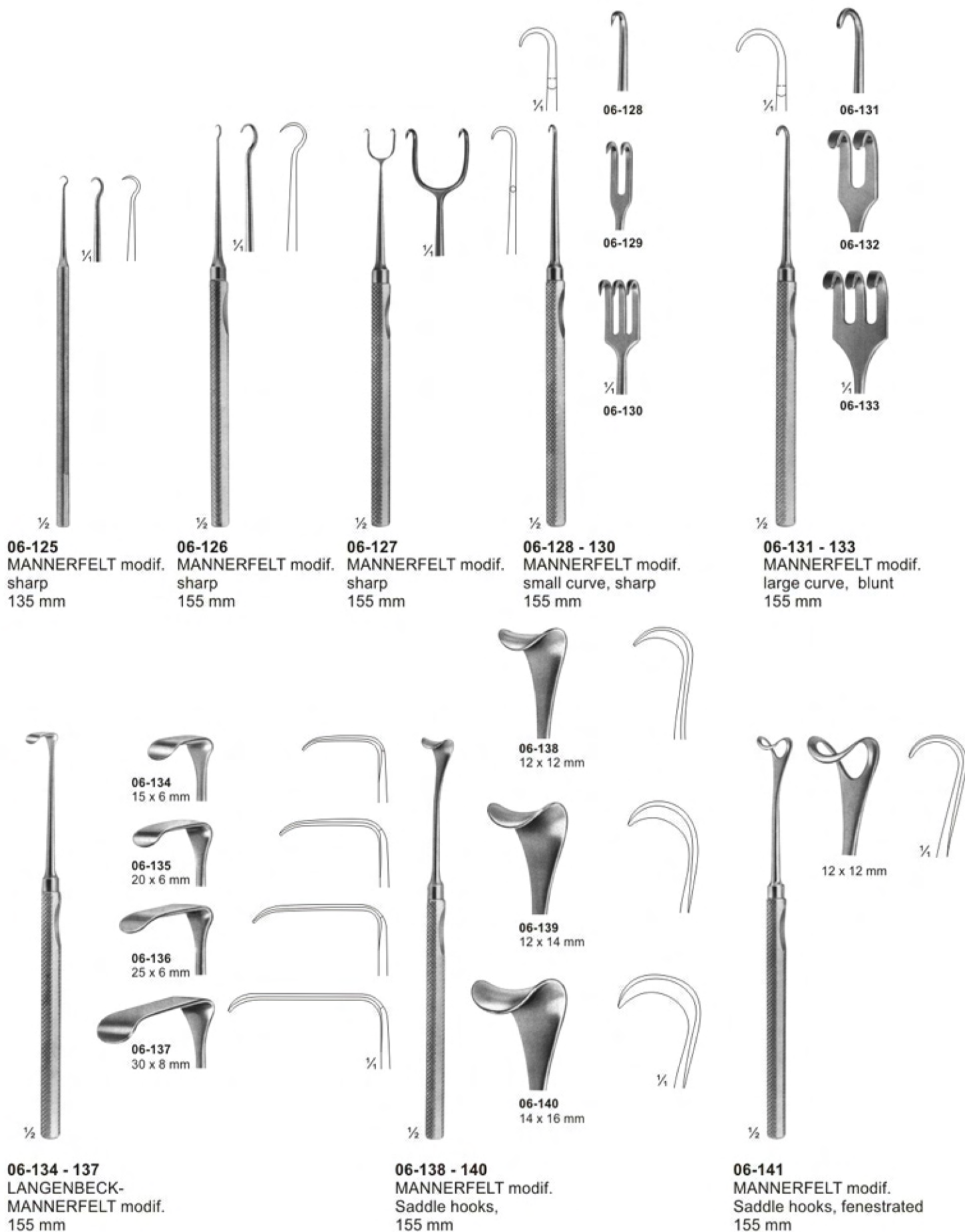



# Retractors



**06-142**  
MASING  
140 mm

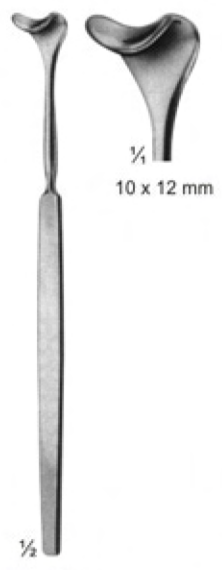

**06-143**  
COTTLE  
140 mm

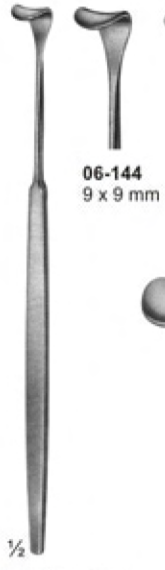

**06-144 - 148**  
DESMARRES  
140 mm

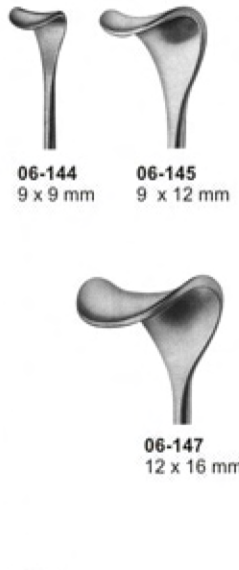

**06-144**  
9 x 9 mm



**06-145**  
9 x 12 mm



**06-146**  
11 x 14 mm



**06-147**  
12 x 16 mm



**06-148**  
13 x 18 mm

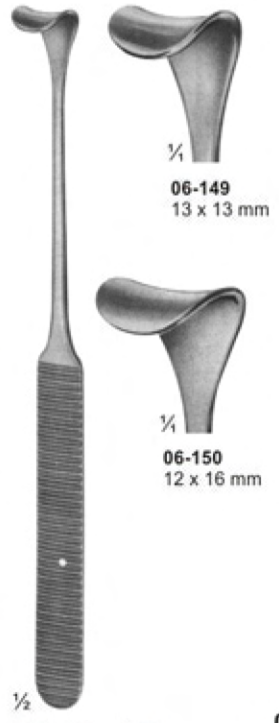

**06-149 - 150**  
KONIG  
180 mm

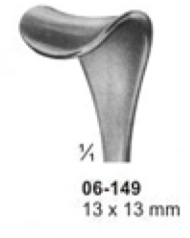

**06-149**  
13 x 13 mm

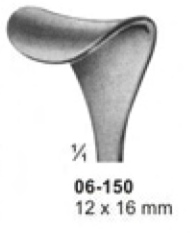

**06-150**  
12 x 16 mm



**06-151**  
CUSHING-KOCHER  
175 mm



**06-152 - 153**  
KOCHER  
205 mm

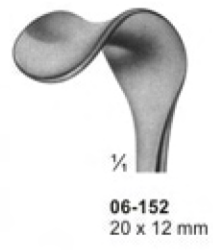

**06-152**  
20 x 12 mm

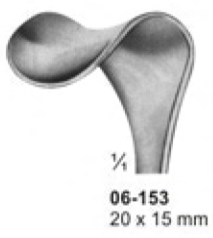

**06-153**  
20 x 15 mm

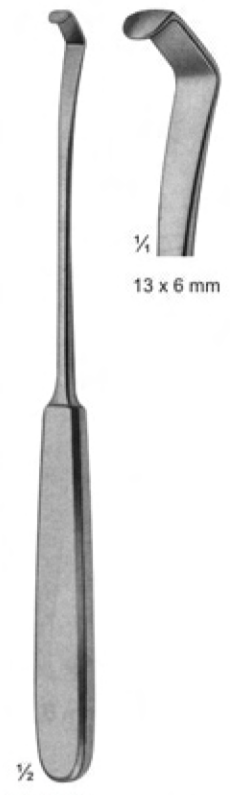

**06-154**  
SCHOENBORN  
200 mm



**06-154**  
13 x 6 mm

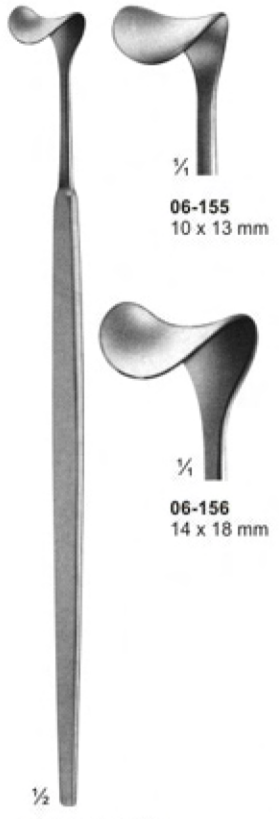

**06-155 - 156**  
CUSHING  
205 mm

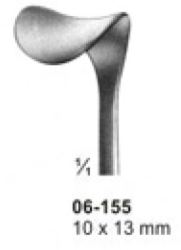

**06-155**  
10 x 13 mm

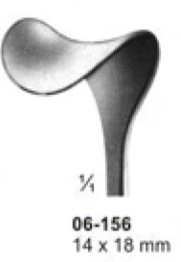

**06-156**  
14 x 18 mm



**06-157**  
CUSHING  
205 mm



20 x 15 mm



20 x 19 mm



**06-158 - 160**  
CUSHING  
250 mm



**06-158**  
11 x 14 mm

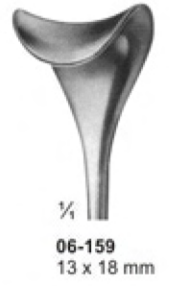

**06-159**  
13 x 18 mm

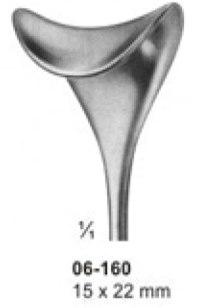

**06-160**  
15 x 22 mm



# Retractors

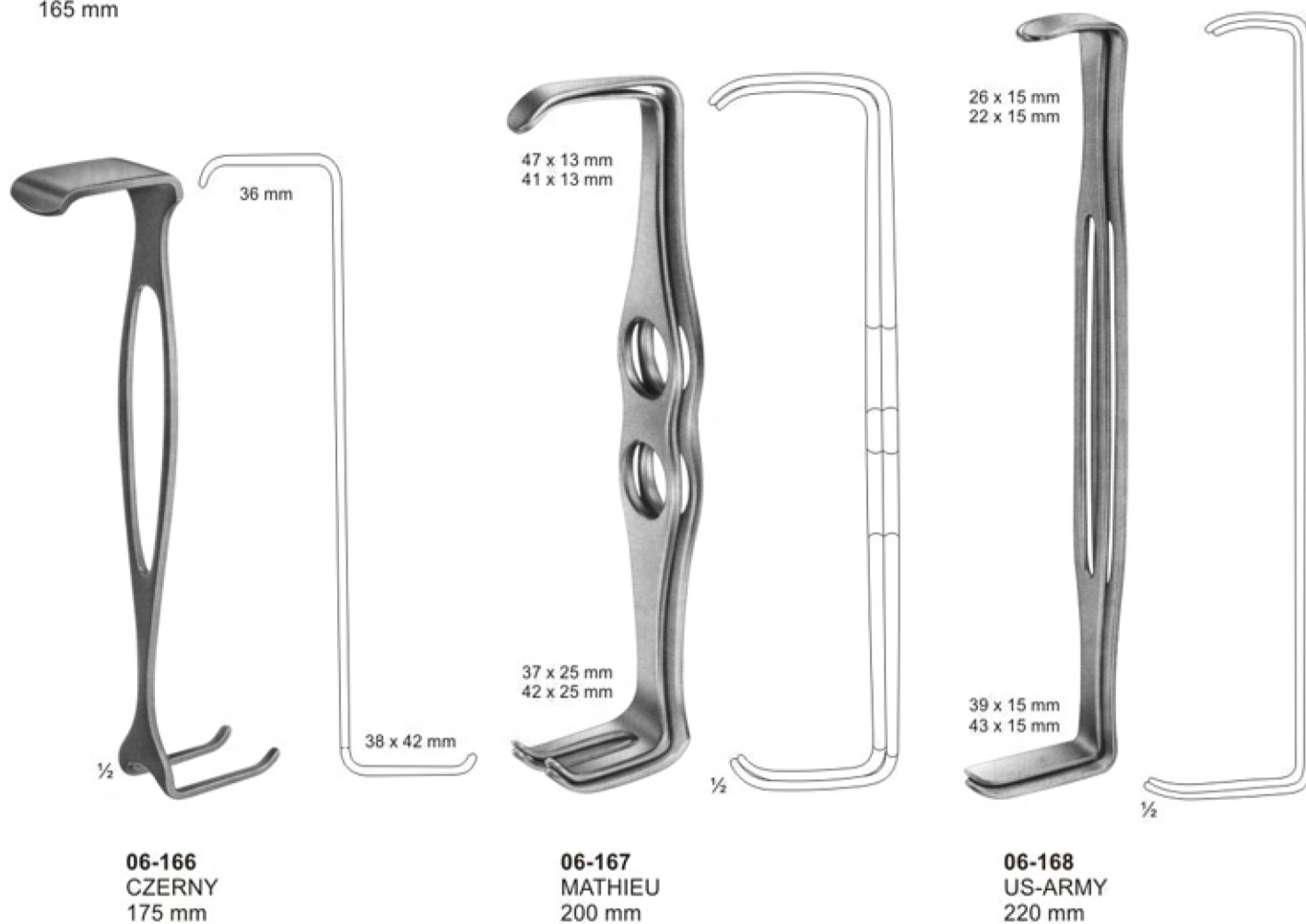
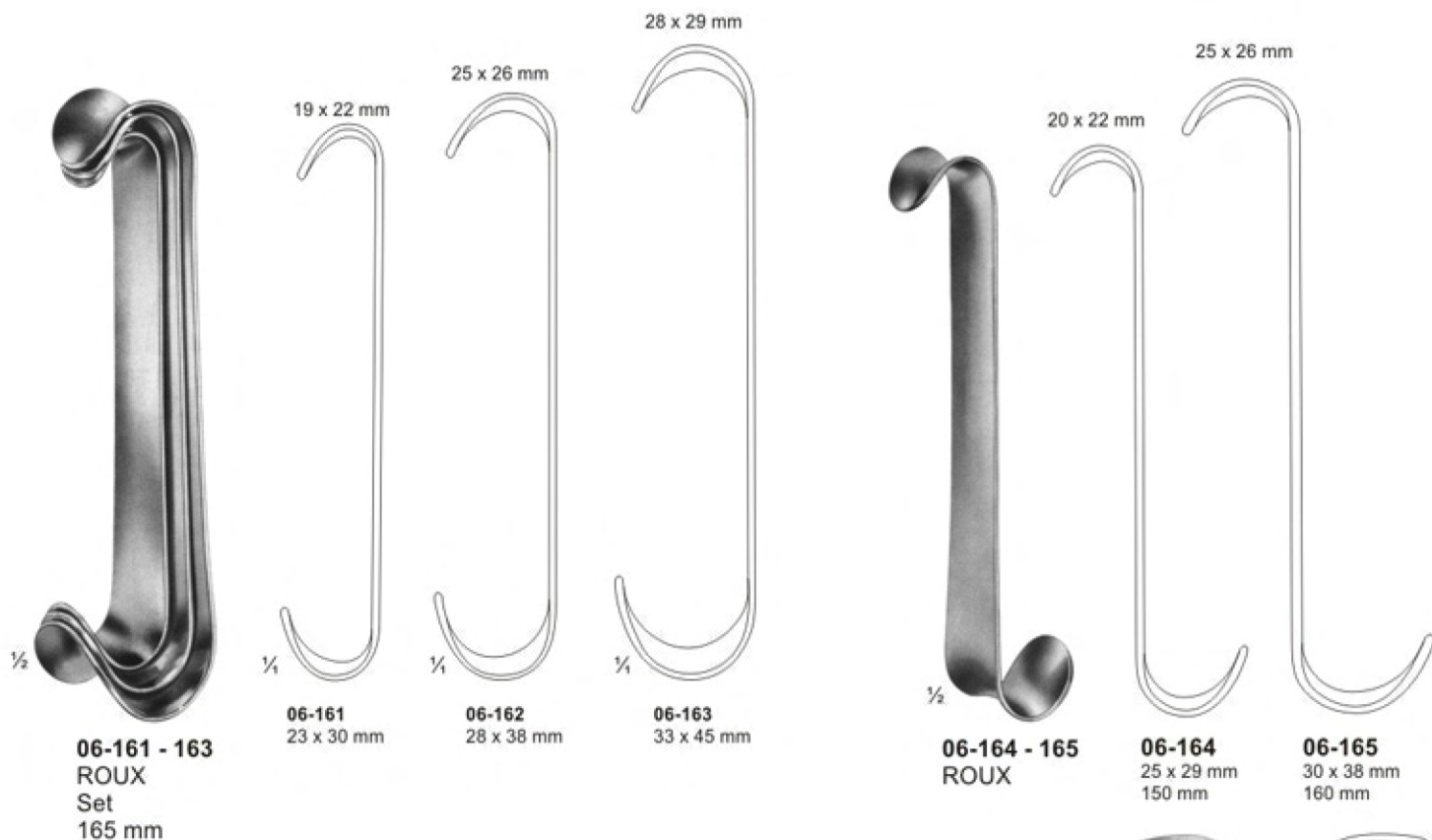

# Retractors

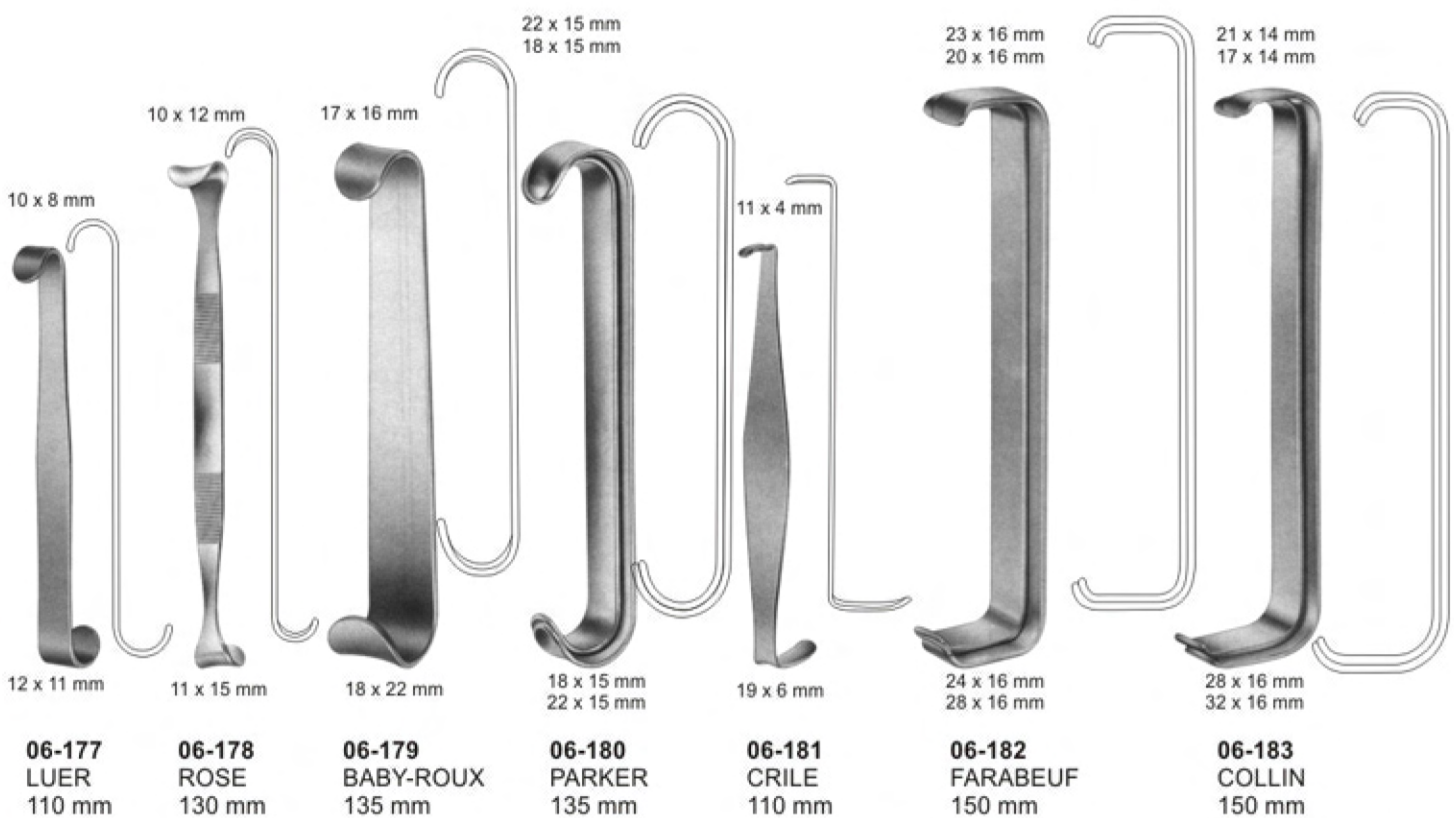

# Bone Retractors and Retractors



**06-184**  
KOCHER  
sharp  
205 mm



**06-185**  
KOCHER  
sharp  
220 mm



**06-186**  
KOCHER  
sharp  
220 mm



**06-187**  
VOLKMANN  
blunt  
220 mm



**06-188**  
VOLKMANN  
sharp  
220 mm



**06-189 - 06-196**  
VOLKMANN  
225 mm

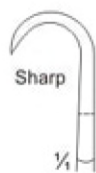

**06-189**  
9 x 8 mm



**06-190**  
9 x 13 mm



**06-191**  
9 x 19 mm



**06-192**  
9 x 29 mm

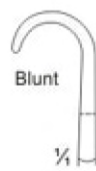

**06-193**  
8,5 x 8 mm



**06-194**  
8,5 x 13 mm



**06-195**  
8,5 x 19 mm

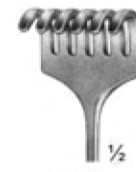

**06-196**  
8,5 x 29 mm

# Retractors



$\frac{1}{2}$   
**06-197**  
 15 x 15 mm  
 220 mm



$\frac{1}{2}$   
**06-198**  
 20 x 22 mm  
 215 mm



$\frac{1}{2}$   
**06-199**  
 28 x 28 mm  
 235 mm



$\frac{1}{2}$   
**06-197 - 06-199**  
 MIDDELDORPF



$\frac{1}{2}$   
**06-200**  
 BUCHS  
 205 mm



38 x 18 mm



67 x 17 mm



$\frac{1}{2}$   
**06-201**  
 CASPAR  
 210 mm

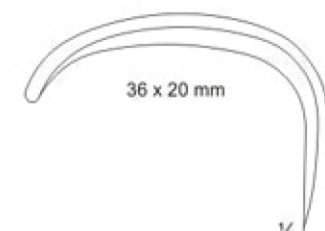

36 x 20 mm

$\frac{1}{2}$   
**06-202**  
 KOCHER  
 230 mm



# Retractors, Vario Retractor System



06-203 80 x 20 mm



06-203- 06-209  
BRUNNER  
275 mm

- 06-203 80 x 20
- 06-204 100 x 25
- 06-205 120 x 25
- 06-206 130 x 30
- 06-207 140 x 30
- 06-208 160 x 30
- 06-209 180 x 30

1/2



06-210  
Handle with cold  
light carrier for  
retractor blades.  
280 mm

1/2

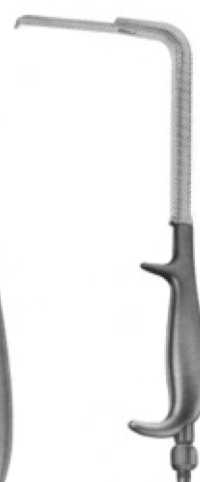

Handle arrange-  
ment verriable

# Retractors, Lung Spatulas



## Retractors for deep surgery (Abdominal Retractors)

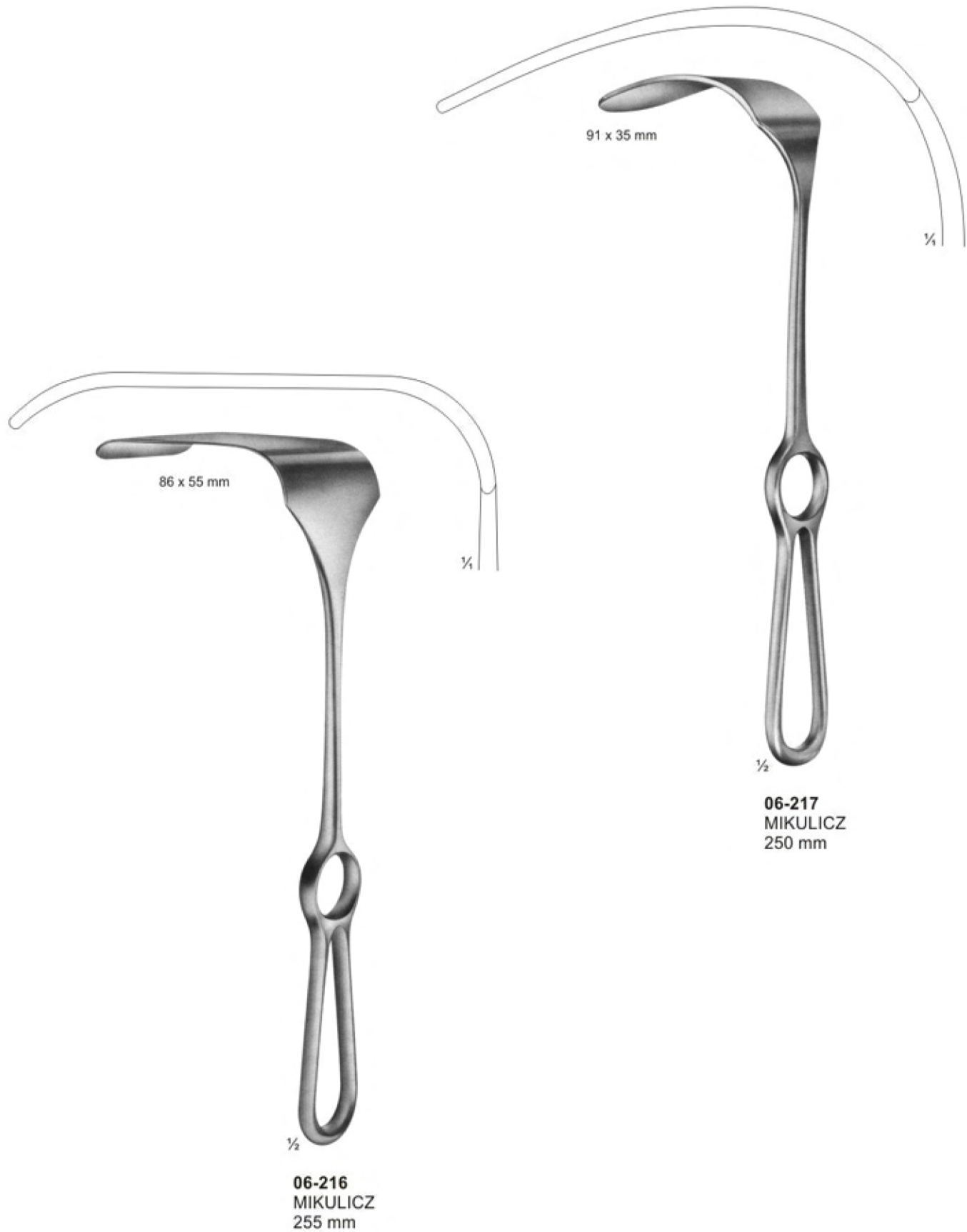

# Retractors, Abdominal Retractors



slightly concave

53 x 80 mm

- 06-229 Fig.1 32 x 40 mm
- 06-230 Fig.2 34 x 50 mm
- 06-231 Fig.3 41 x 60 mm
- 06-232 Fig.4 46 x 75 mm
- 06-233 Fig.5 64 x 85 mm

**06-218 - 06-228**  
DOYEN  
240 mm

**06-229 - 06-233**  
FRITSCH  
240 mm

**06-234**  
DOYEN  
250 mm

	width of blades	
	35 mm, 45 mm, 60 mm	
length of blades		
62 mm	06-218, 06-222, 06-226	
92 mm	06-219, 06-223, 06-227	
122 mm	06-220, 06-224, 06-228	
160 mm	06-221, 06-225	



# Abdominal- and Intestinal Spatulas Bauch- und Darmspatel



**06-235**  
LERICHE  
255 mm

**06-236**  
KUMMEL  
Mealleable  
285 mm

**06-237**  
MIKULICZ  
29 mm  
250 mm

**06-238 - 06-239**  
KADER  
**06-238** 30 mm  
**06-239** 40 mm  
270 mm

# Self-Retaining Retractors

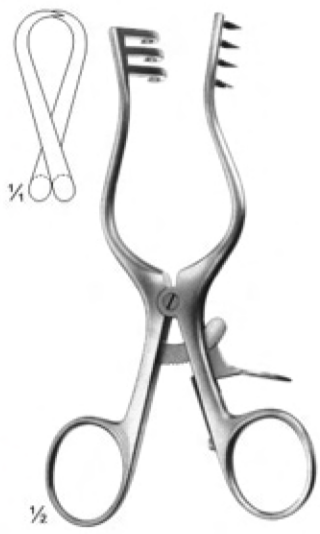

**06-240**  
WEITLANER  
sharp  
130 mm

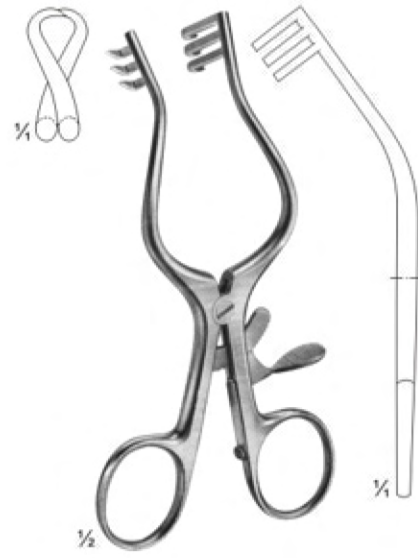

**06-241**  
WULLSTEIN  
sharp  
130 mm

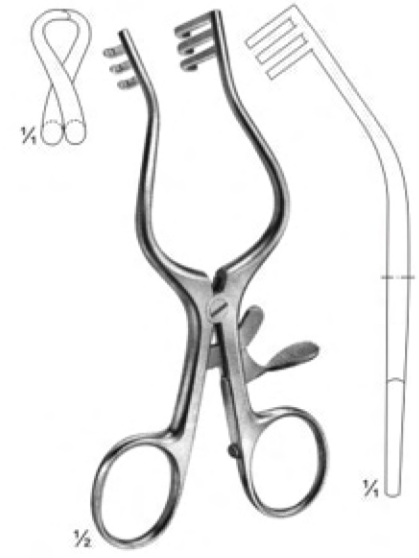

**06-242**  
WULLSTEIN  
blunt  
130 mm



**06-243**  
WEITLANER  
sharp  
165 mm



**06-244**  
PLESTER  
blunt  
110 mm



**06-245**  
PERKINS  
130 mm

# Special Retractors



1/2

**06-246**  
**JOLL ( FRIEDMAN )**  
 Thyroid- and vaginal retractor  
 155 mm



1/2

**06-247**  
**JACKSON BURROWS**  
 Retractor, blunt  
 185 mm



1/4



1/2

**06-249**  
**GELPI**  
 Skin- and vaginal retractor  
 175 mm



1/4



1/2

**06-250**  
**DE BAKEY**  
 Femur retractor  
 145 mm

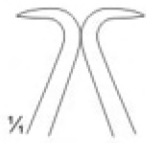

1/4



1/2

**06-248**  
**GELPI**  
 Vaginal retractor  
 135 mm

# Lamina Spreaders



**06-251**  
CLOWARD  
155 mm



**06-252**  
CLOWARD  
135 mm



**06-253**  
INGE  
170 mm

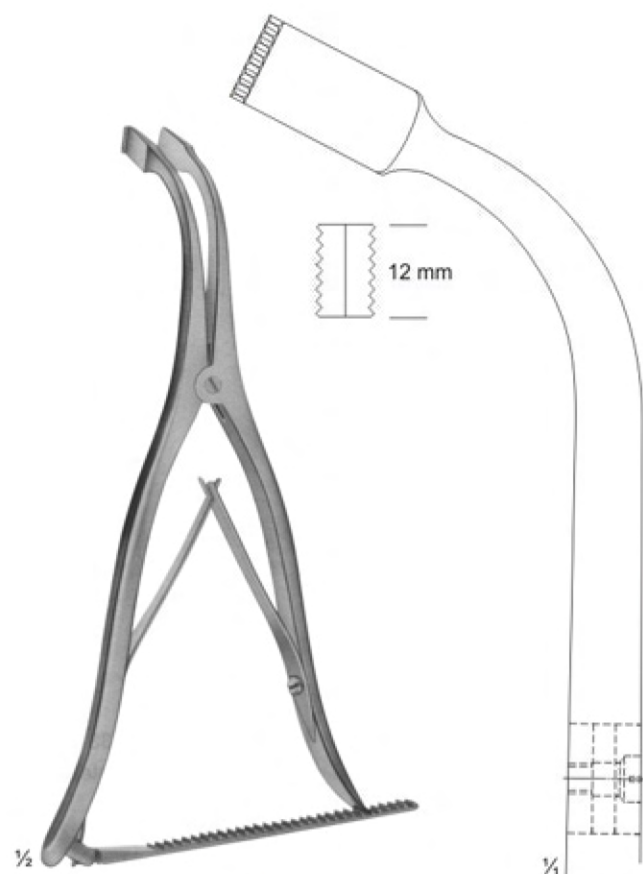

**06-254**  
INGE  
275 mm



# Abdominal Retractors

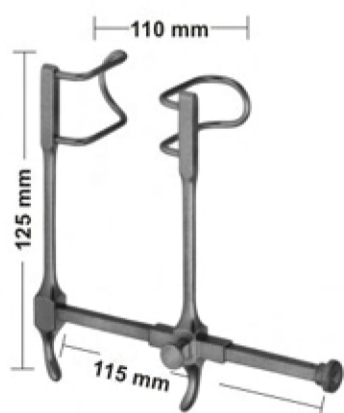

**06-255**  
GOSSET  
Blades:38 mm deep

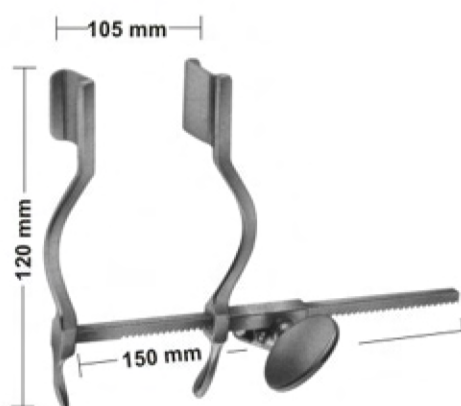

**06-256**  
HERTZLER  
Blades 20 X 25 mm

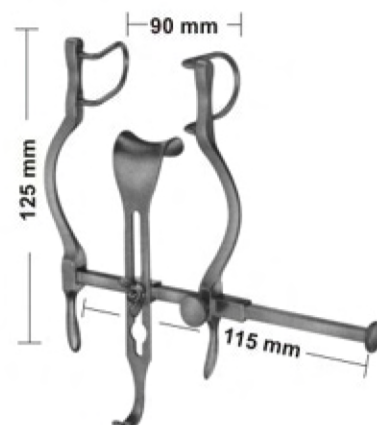

**06-257**  
BALFOUR-BABY  
Lateral blades 27 mm deep  
Center blade 21x24 mm

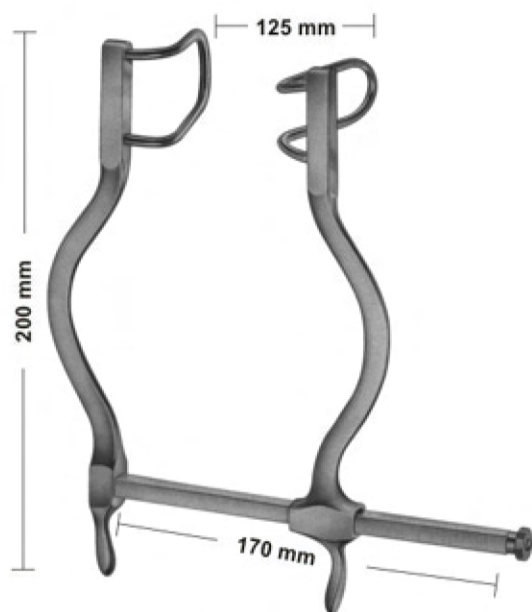

**06-258**  
GOSSET  
Blades:55mm deep

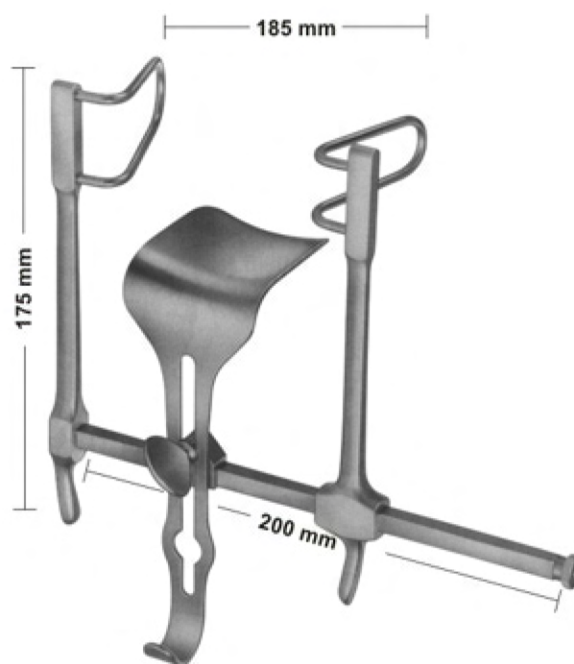

**06-259**  
GOSSET  
Lateral blades 58 mm deep  
Center blade 59 x 57 mm

# Abdominal Retractors

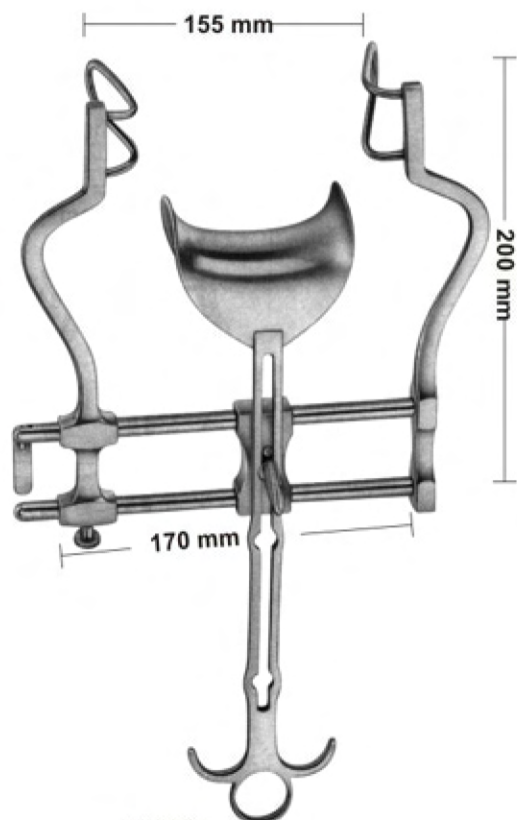

**06-260**  
BALFOUR  
Lateral blades 60 mm deep  
Center blade 47 x 80 mm

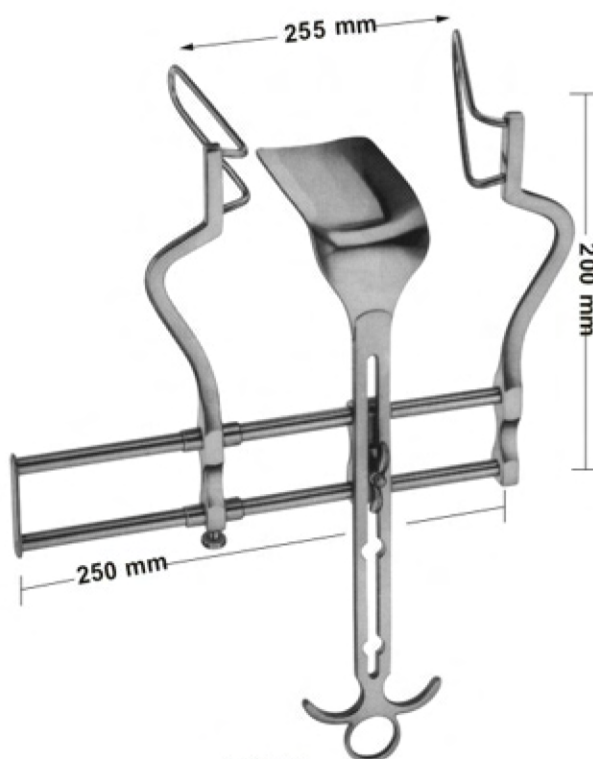

**06-261**  
BALFOUR  
Lateral blades 105 mm deep  
Center blade 107x 59 mm

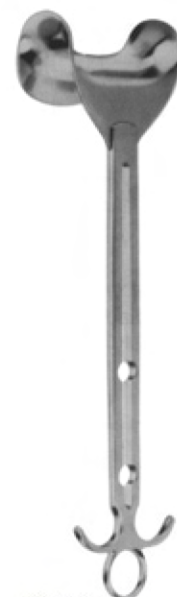

**06-262**  
Center blade only  
54x80 mm

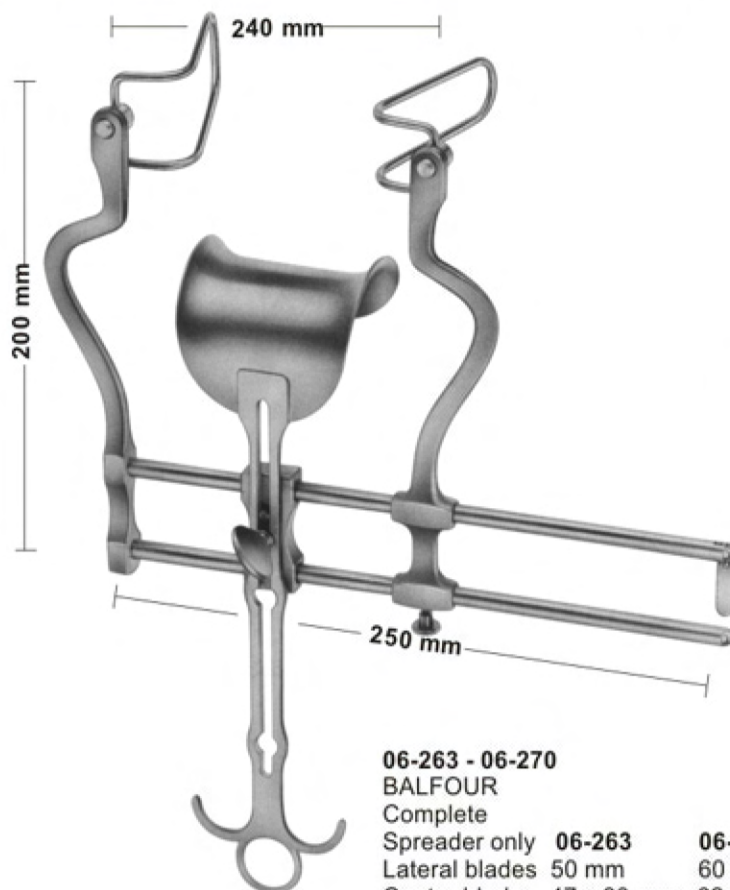

**06-263 - 06-270**  
BALFOUR  
Complete  
Spreader only

<b>06-263</b>	<b>06-264</b>	<b>06-265</b>	<b>06-266</b>
Lateral blades 50 mm	60 mm	75 mm	90 mm
Center blade 47 x 80 mm	62x76 mm	80x80 mm	80x80 mm



Lateral blades  
**06-267** 50 mm deep  
**06-268** 60 mm deep  
**06-269** 75 mm deep  
**06-270** 90 mm deep  
Sales Unit of blades: PR = pair

# Organ-, Tissue and Intestinal Grasping Forceps

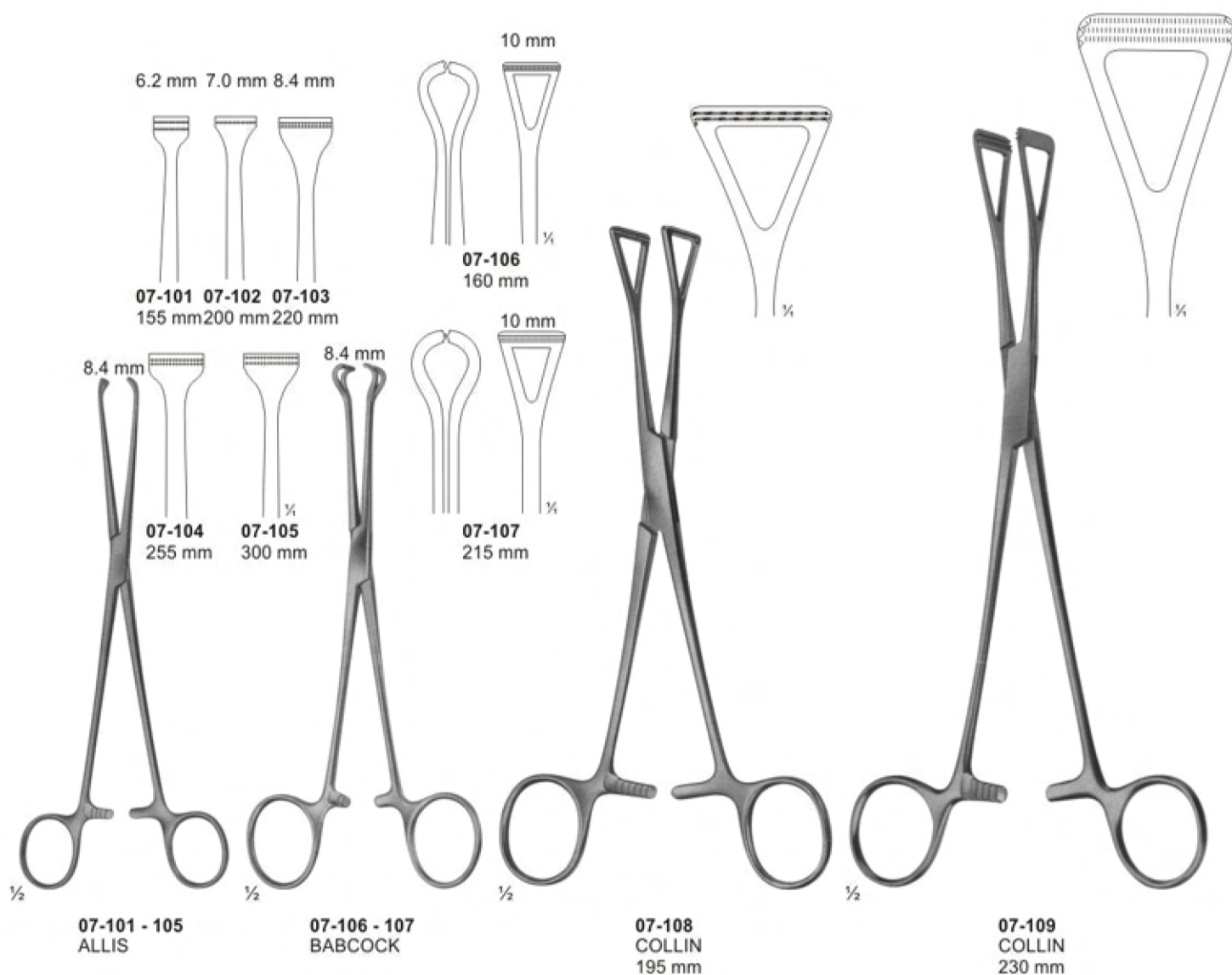

# Intestinal Clamps, soft elastic

## ATRAUMATA

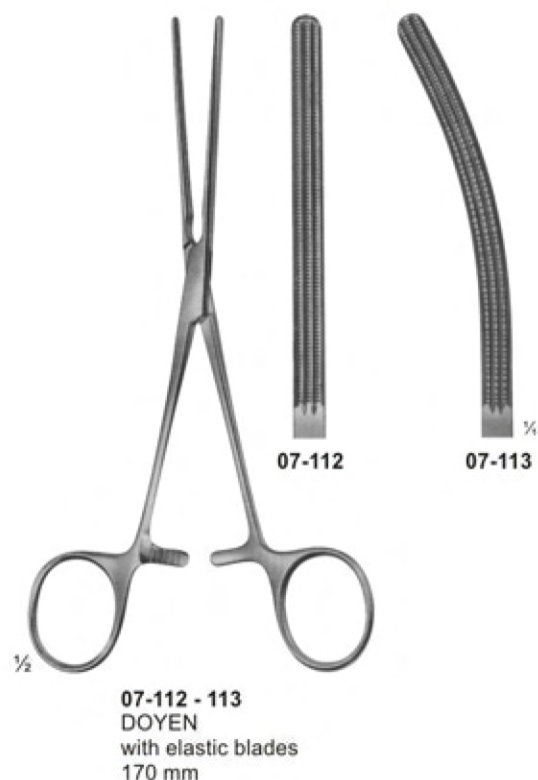
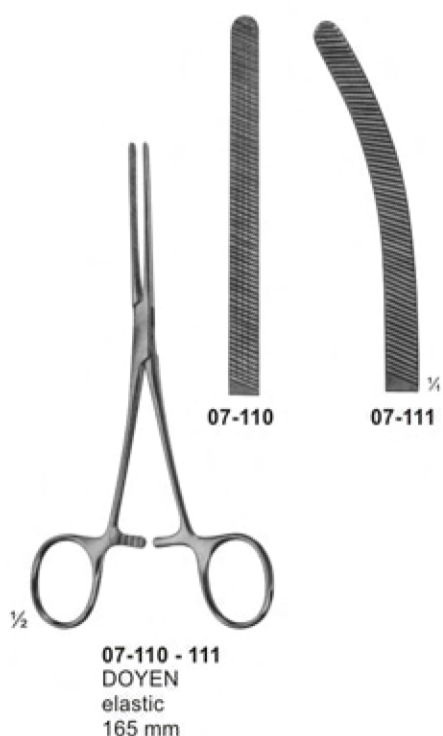

## ATRAUMATA

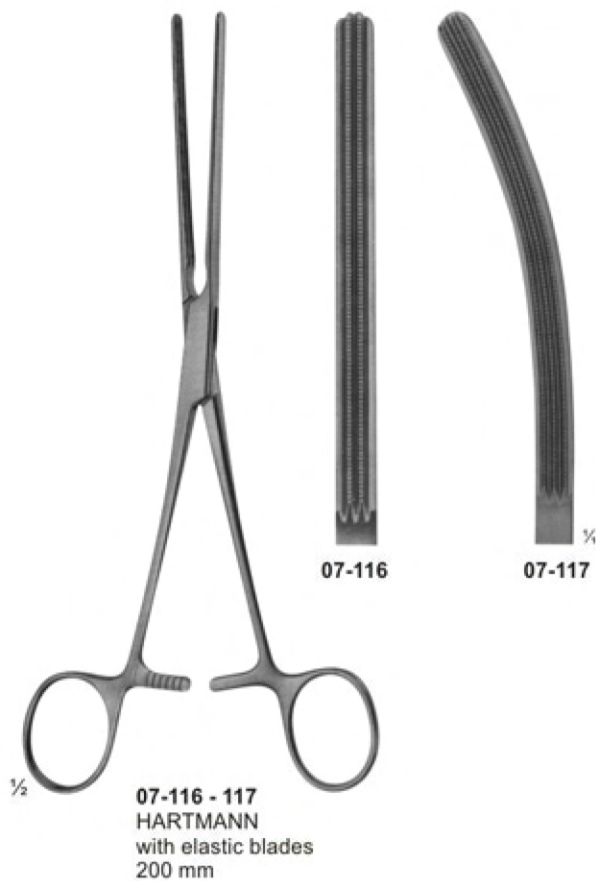
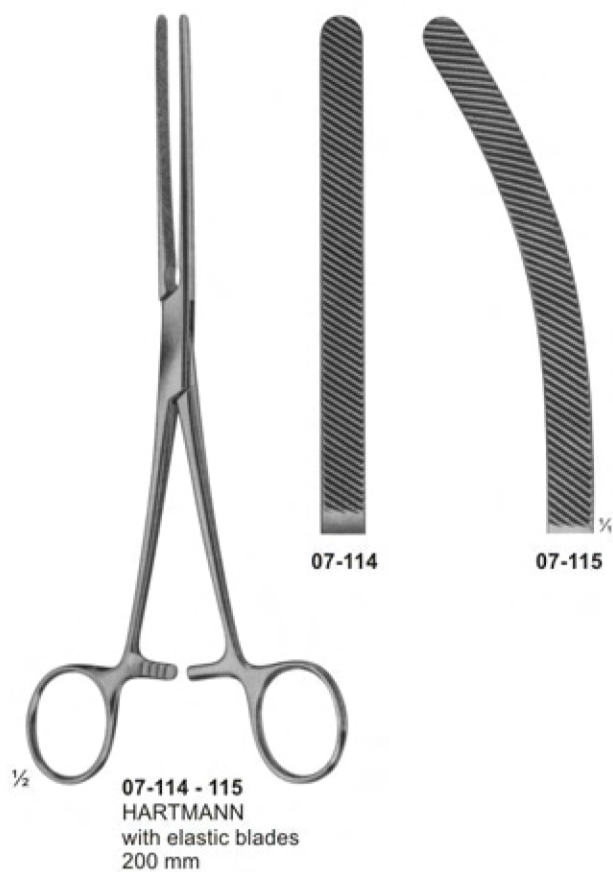



# Intestinal and Pylorus Clamps



**07-118**  
 PAYR  
 Intestinal clamp  
 light pattern,  
 for children  
 180 mm

**07-119**  
 PAYR  
 200 mm

**07-120**  
 PAYR  
 275 mm

**07-121**  
 PAYR  
 Pylorus clamp  
 315 mm

# ATRAUMATA

## Sigmoid Anastomosis Forceps

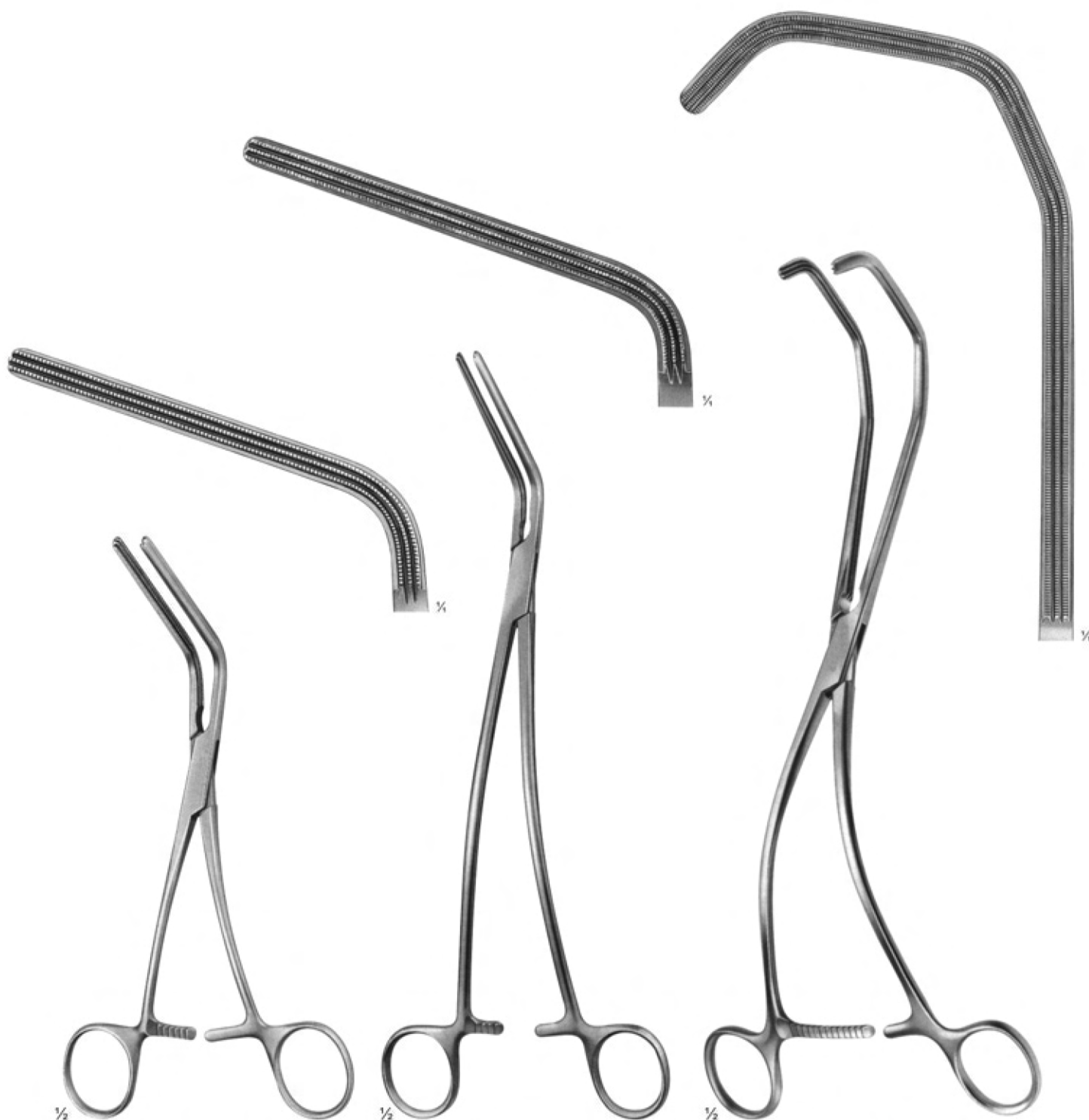

**07-122**  
MORRIS  
175 mm

**07-123**  
DE BAKEY  
(MORRIS modif.)  
240 mm

**07-124**  
KERSTING  
270 mm

# Nasal Specula



**08-101**  
Martin  
13 cm / 5 1/8"



**08-102**  
SIMS  
160 mm



**08-103**  
Tieck-Halle  
13 cm / 5 1/8"



**08-104**  
Killian

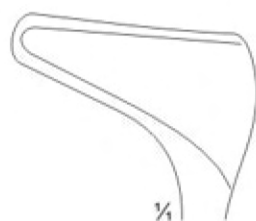

Fig. 1  
14 cm 5 4/8"  
35 mm

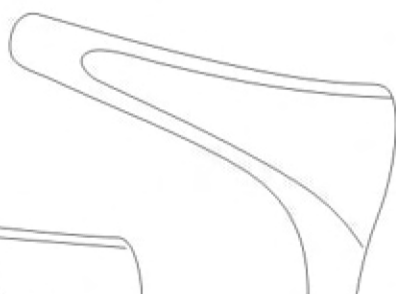

Fig. 2  
14,5 cm / 5 4/8"  
50 mm

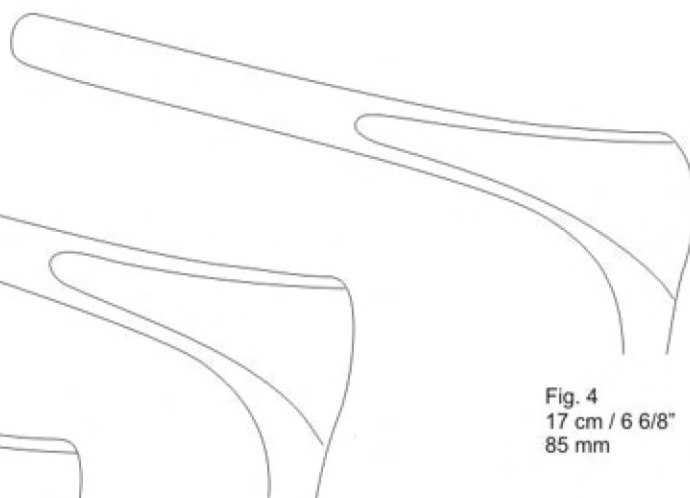

Fig. 3  
16 cm / 6 2/8"  
75 mm

Fig. 4  
17 cm / 6 6/8"  
85 mm

# Nasal Specula



**08-105**  
Cottle

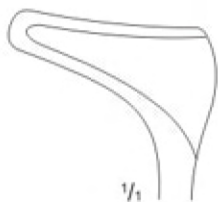

Fig. 1  
13,5 cm / 5 3/8"  
35 mm



Fig. 2  
14 cm / 5 4/8"  
50 mm

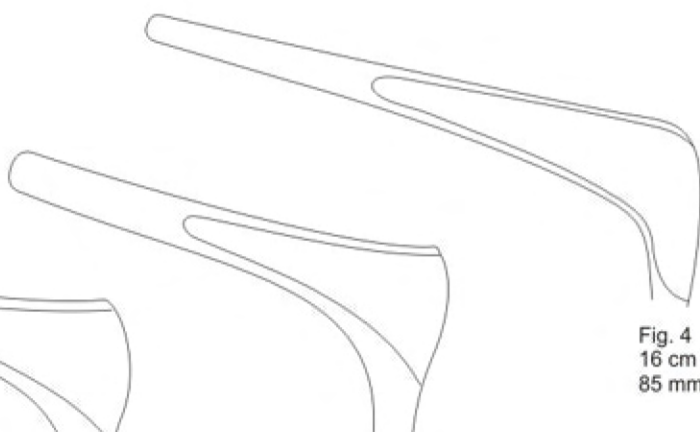

Fig. 3  
16 cm / 6 2/8"  
75 mm

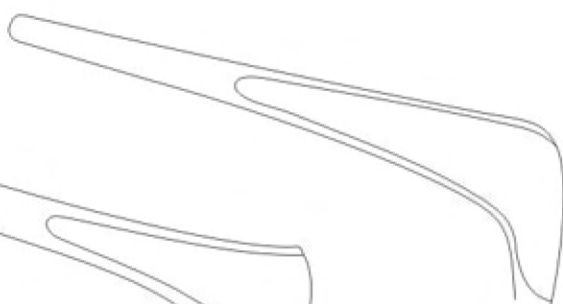

Fig. 4  
16 cm / 6 2/8"  
85 mm



**08-106**  
Goldsmith (Thudichum)  
6,5 cm / 2 4/8"



Fig. 1  
21,0 x 9,5 mm



Fig. 2  
21,0 x 10,5 mm



Fig. 3  
21,0 x 11,5 mm



**08-107**  
Mod. Wien 2  
13,5 cm / 5 1/8"



Fig. 1  
30 mm



**08-108**  
Hartmann-Halle  
16 cm / 6 1/8"



Fig. 1  
27 mm



Fig. 2  
31 mm



Fig. 3  
35 mm



# Anusopes-Sphincteroscopes



08-109  
IVES-FANSLER  
Anuscops  
145 mm  
Ø24mm



08-110  
KELLY  
Sphincteroscope  
160 mm  
Ø21mm



08-111  
KELLY  
Sphincteroscope  
160 mm  
Ø27mm

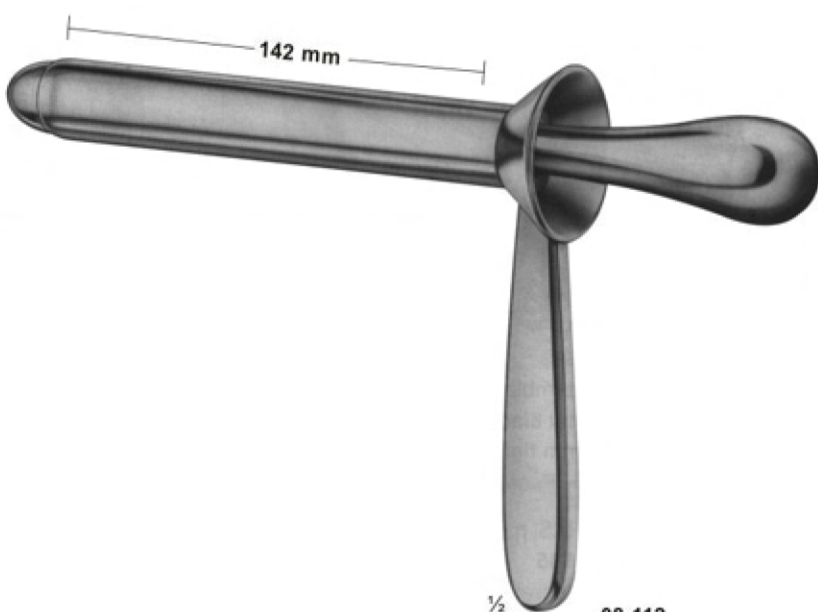

08-112  
KELLY  
Proctoscope  
140 mm  
Ø22mm

# Haemorrhoidal Forceps

## ATRAUMATA

## Pressure Clamp

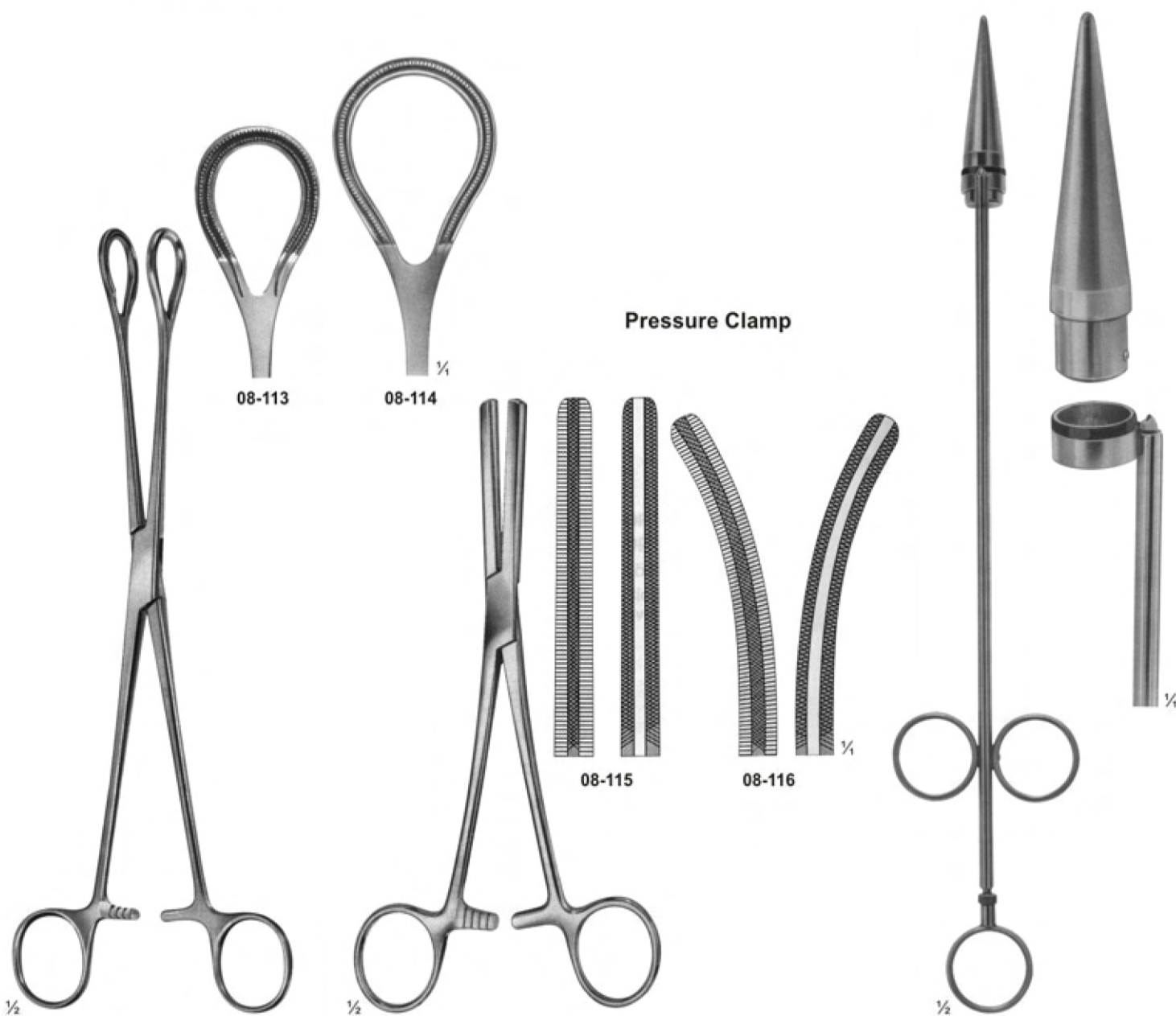

**08-113 - 08-114**  
250 mm  
08-114  
270 mm

**08-115 - 08-116**  
FERGUSSON  
200 mm

**08-117**  
RUDD  
Haemorrhoidal ligator  
with loading  
attachment and 100  
ligature rubber rings  
315 mm

# Gall Duct Forceps



**08-118**  
LOWER  
180 mm



**08-119**  
LAHEY ( SWEET )  
190 mm



**08-120**  
LAHEY  
220 mm



**08-121**  
DESJARDINS  
Gall duct-and cystic forceps  
210 mm



**08-122**  
NISSEN  
Gall duct-and cystic forceps  
215 mm

# Gall Duct Dilators and Gall Stone Scoops

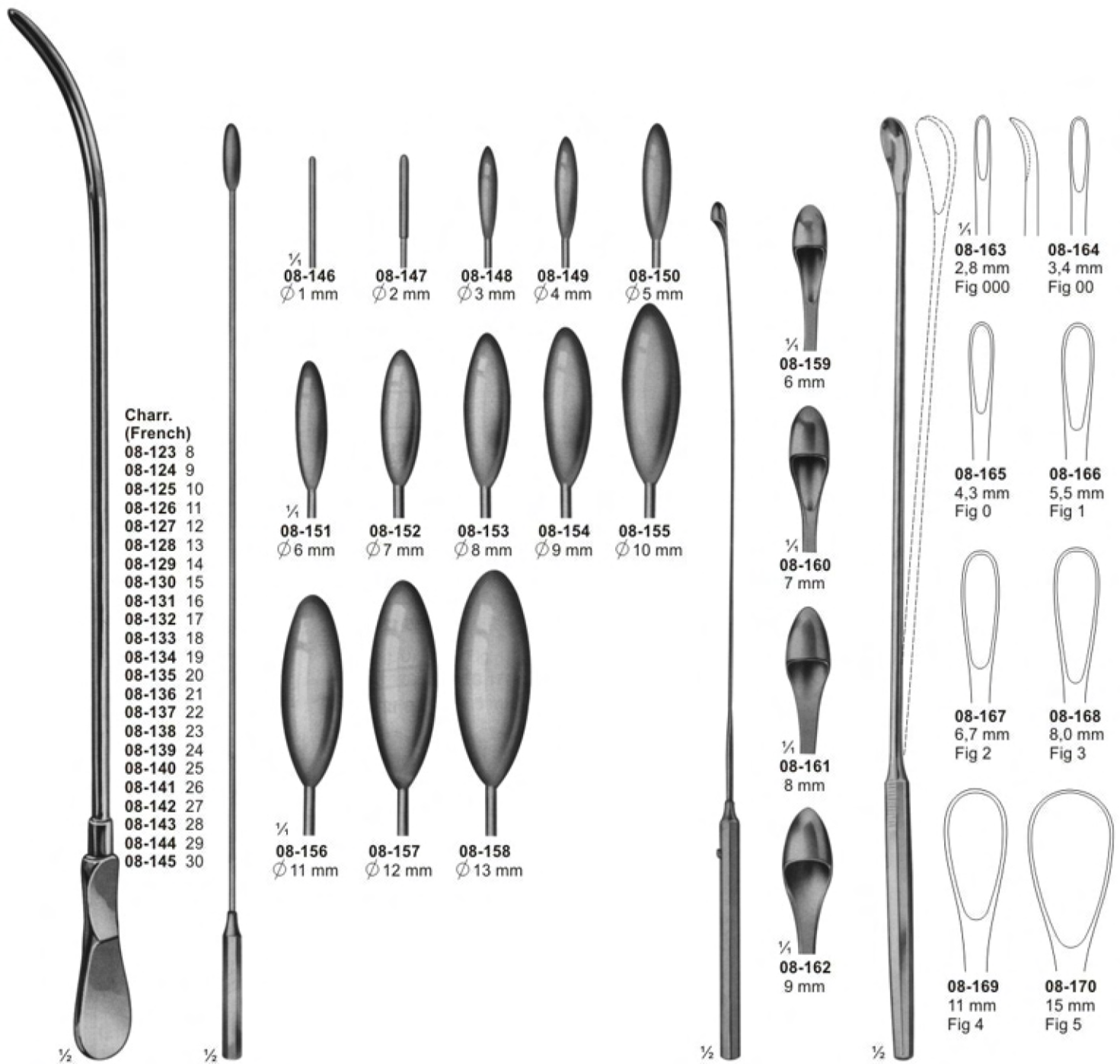

**08-123 - 08-145**  
DITTEL  
Metall bougies and dilating sounds, stiff  
345 mm

**08-146 - 08-158**  
BAKES  
Common bile duct dilators, malleable  
08-146 - 08-150 315 mm  
08-151 - 08-158 320 mm

**08-159 - 08-162**  
DESJARDINS  
Probe and catch with flexible shaft  
300 mm

**08-163 - 08-170**  
LUER-KOERTE modif  
with malleable shaft  
310 mm



# Gall Stone Forceps

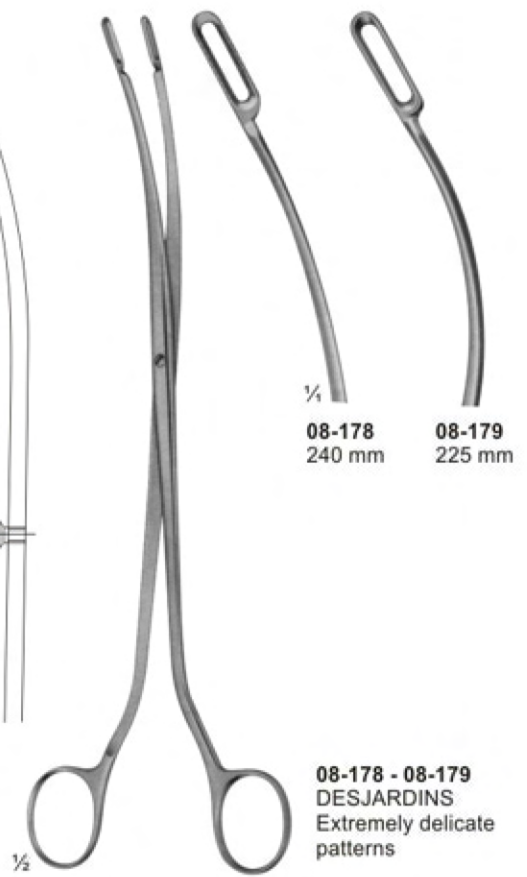
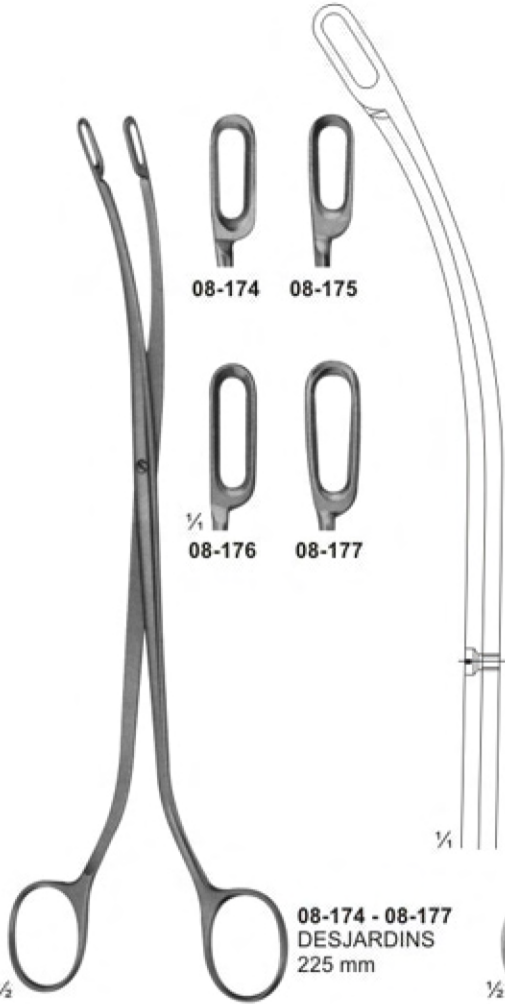
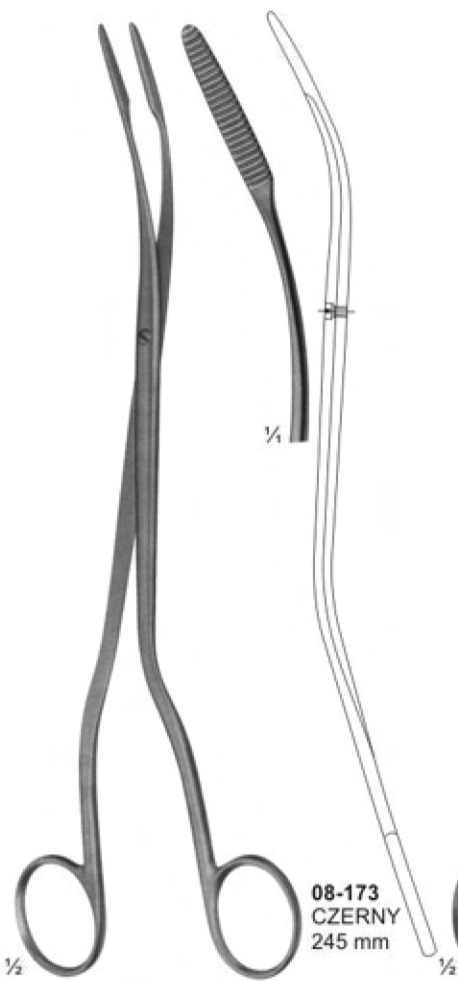
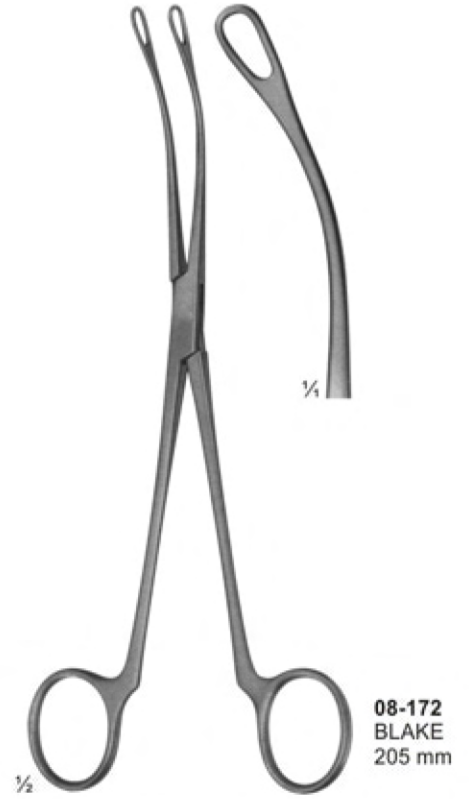

# Kidney Clamps

## ATRAUMATA

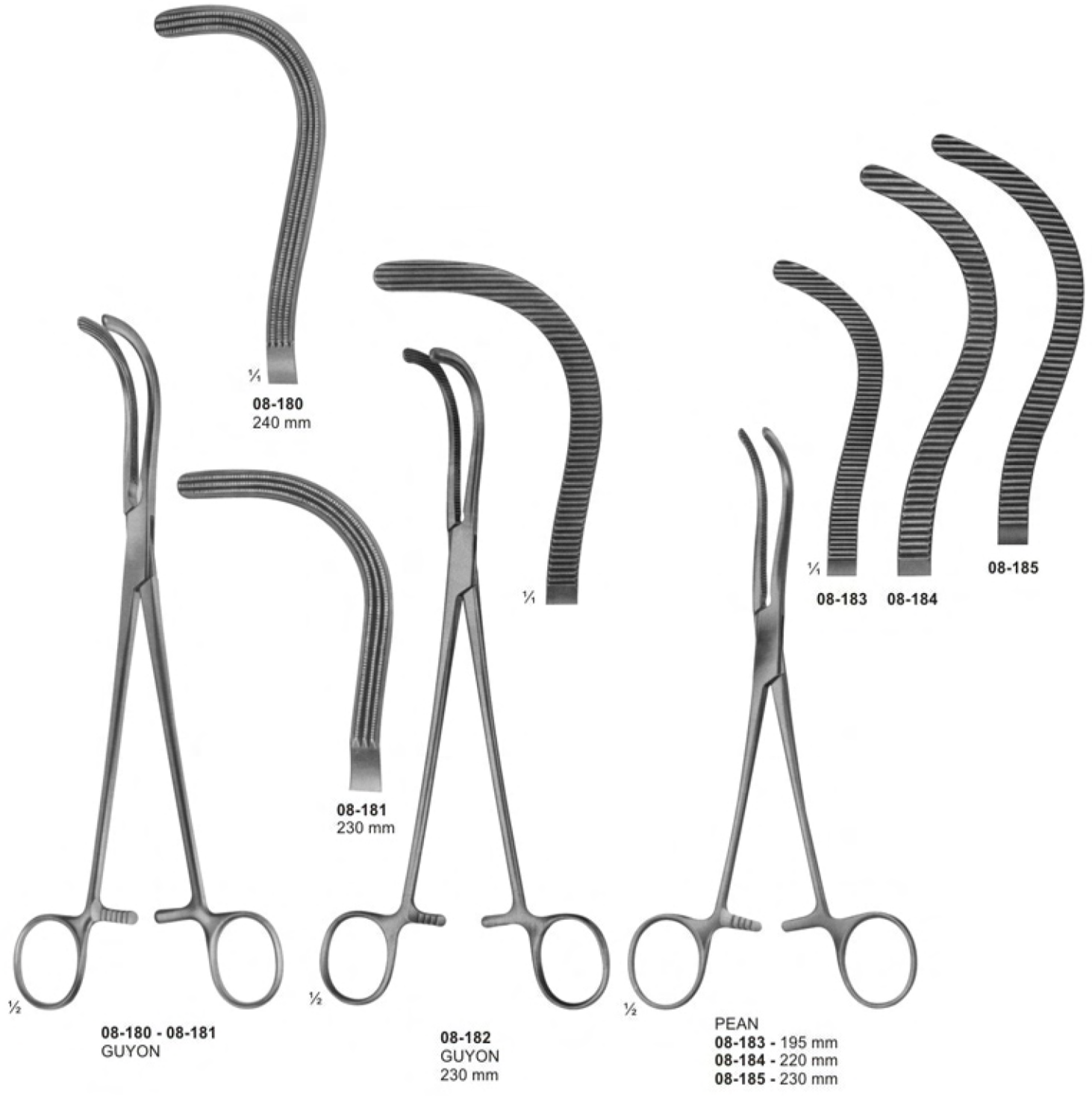

# Kidney Stone Forceps



08-186



08-187



08-188



$\frac{1}{4}$   
08-189



08-190



08-191



$\frac{1}{4}$   
08-192



$\frac{1}{2}$

08-186 - 08-189  
RANDALL  
225 mm



$\frac{1}{2}$

08-190 - 08-192  
RANDALL  
190 mm

# Bladder Retractors

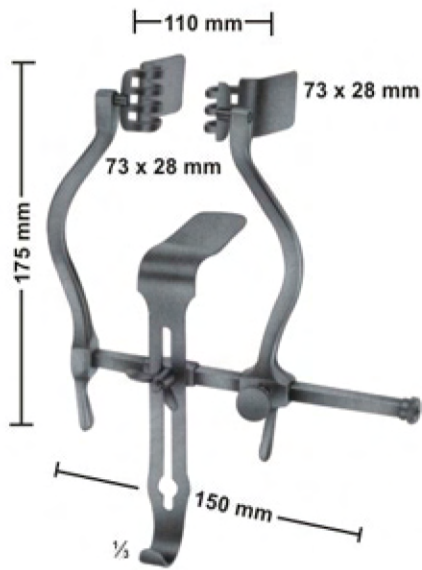

**09-101**  
**JUDD-MASSON**  
 Bladder-and suprapubic retractor

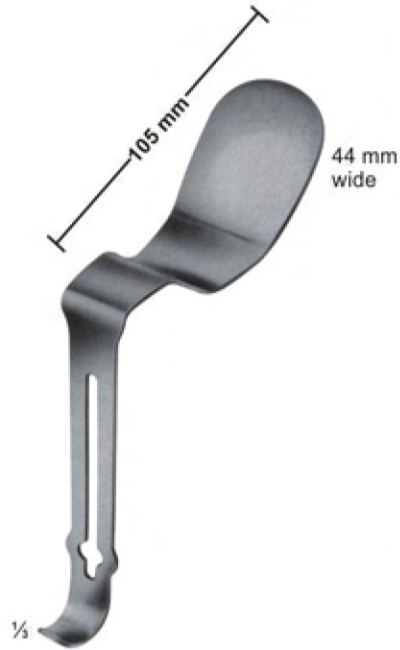

**09-102**  
**MILLIN**  
 Center bladder for retro pubic prostatectomy



**09-103**  
**MILLIN**  
 Bladder retractor, complete 105X45 mm



**09-104**  
**LEGUEU**  
 Bladder retractor Center blade 80 x 31 mm



**09-105**  
**KOCHER**  
 Bladder spatula 235 mm



# Trocars



**09-106**  
KLIMA ROSEGGER  
35 X 1,8 mm  
Sternal puncture needle



**09-107**  
Universal trocar  
with 4 tips



NELSON



**09-113 - 116**  
Inside diam. Outside diam  
**09-113** 2,2 mm 3,0 mm  
**09-114** 3,0 mm 4,0 mm  
**09-115** 4,0 mm 5,0 mm  
**09-116** 5,0 mm 6,0 mm  
for abdominal puncture,  
with stop-cock and lateral  
drain

**09-108 - 112**  
Inside diam. Outside diam  
**09-108** 2,2 mm 3,0 mm  
**09-109** 3,0 mm 4,0 mm  
**09-110** 4,0 mm 5,0 mm  
**09-111** 5,0 mm 6,0 mm  
**09-112** 5,5 mm 6,5 mm  
for hydrocele and abdominal  
puncture



**09-117 - 118**  
Inside diam. Outside diam  
**09-117** 6,5 mm 8,0 mm  
**09-118** 9,0 mm 10,0 mm  
Empyema trocar  
BUELEU



**09-119 - 122**  
Inside diam. Outside diam  
**09-119** 3,0 mm 4,0 mm  
**09-120** 3,6 mm 4,6 mm  
**09-121** 4,3 mm 5,3 mm  
**09-122** 5,0 mm 6,0 mm  
Gall bladder trocars. OCHSNER



**09-123**  
PIERCE  
Antrum trocar  
Ø 4,0 mm



**09-124**  
COAKLEY  
Antrum trocar  
3,0 mm

# Vaginal Specula

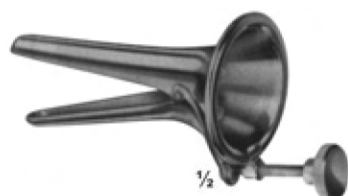

**10-101**  
COLLIN  
for children  
53 x 10 mm

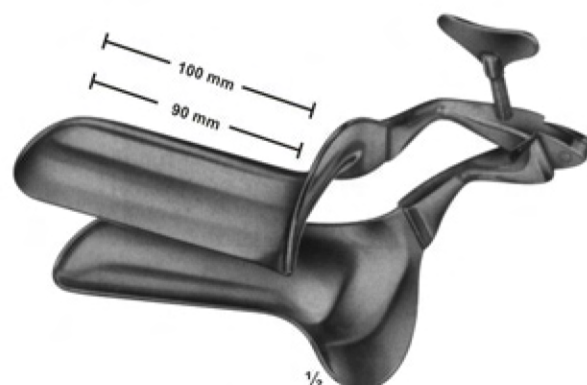

**10-102 - 105**  
COLLIN  

<b>10-102</b>	100/90mm	28 mm
<b>10-103</b>	100/90mm	32 mm
<b>10-104</b>	105/95mm	35 mm
<b>10-105</b>	115/105mm	40 mm

 Total length/working length      width



**10-106**  
COLLIN  
for virgins  
95/85 x 18 mm



**10-107**  
CUSCO  
for virgins  
75 x 17 mm



**10-108**  
CUSCO  
for virgins  
75 x 17 mm

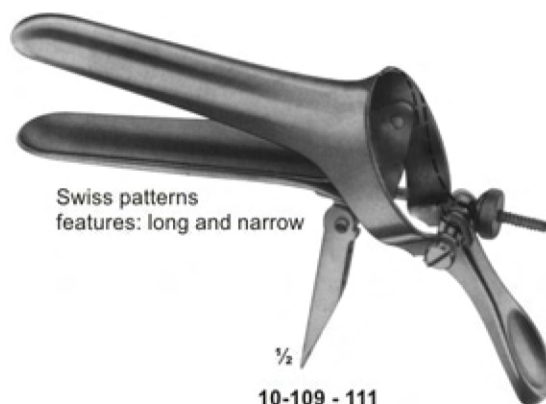

**10-109 - 111**  
CUSCO  

<b>10-109</b>	92X23-25 mm
<b>10-110</b>	100x25-27 mm
<b>10-111</b>	110x27-30 mm

## Vaginal Specula- Sets, upper and lower blades



**10-112 - 114**  
GRAVE  
10-112 75X20 mm  
10-113 95X30 mm  
10-114 105X33 mm

½



**10-115 - 116**  
PEDERSON  
10-115 100X22 mm  
10-116 120X25 mm

½



**10-117 - 118**  
BRIESKY  
10-117 72X25 mm / 77X30 mm 140 mm  
10-118 75X30 mm / 92X38 mm 170 mm

½



½

**10-119**  
SIMS  
70 X 26 mm / 75 X 30 mm  
75 X 30 mm / 80 X 35 mm  
80 X 36 mm / 90 X 40 mm  
175 mm

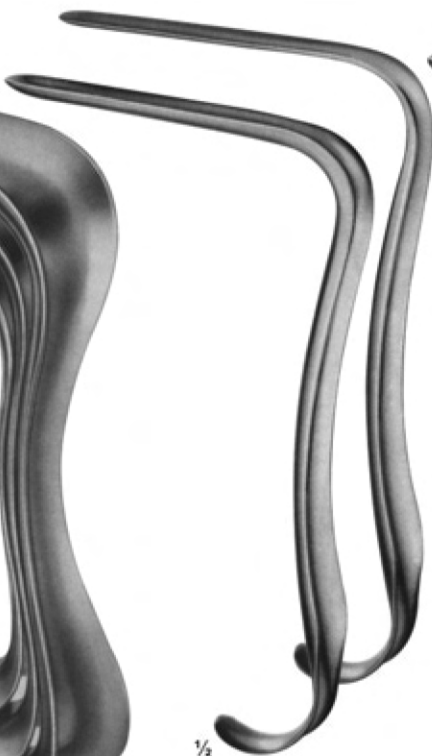

½

**10-120 - 122**  
SEIDL  
10-120 80X8 mm  
10-121 80X10 mm  
10-122 90X14 mm  
For children and infants  
170 mm



½

**10-123**  
KRISTELLER  
70X15 mm, ( 170 mm )  
For children



½

**10-124 - 10-126**  
KRISTELLER  
10-124 70X27 mm  
10-125 75X30 mm  
10-126 90X36 mm  
175 mm



# Vaginal Specula- upper and lower blades



**10-127 - 131**  
**KRISTELLER**  
 10-127 110X18 mm  
 10-128 110X20 mm  
 10-129 110X27 mm  
 10-130 110X30 mm  
 10-131 110X36 mm  
 220 mm

**10-132 - 10-135**  
**KRISTELLER**  
 Upper blades

**10-136 - 10-139**  
**KRISTELLER**  
 Lower blades



# Vaginal Specula



# Vaginal Retractors



1/2  
**10-154**  
**JOLL (FRIEDMAN)**  
 155 mm



1/2  
**10-155**  
**RICHTER**  
 170 mm



1/2  
**10-156**  
**GELPI**  
 135 mm



1/2  
**10-157**  
**GELPI**  
 175 mm

# Uterine Dilators



1/2

**11-101 - 143**  
HEGAR  
with very conical point  
185 mm

11-101	1	mm	11-123	23	mm
11-102	2	mm	11-124	24	mm
11-103	3	mm	11-125	25	mm
11-104	4	mm	11-126	26	mm
11-105	5	mm	11-127	1	1/2mm
11-106	6	mm	11-128	2	1/2mm
11-107	7	mm	11-129	3	1/2mm
11-108	8	mm	11-130	4	1/2mm
11-109	9	mm	11-131	5	1/2mm
11-110	10	mm	11-132	6	1/2mm
11-111	11	mm	11-133	7	1/2mm
11-112	12	mm	11-134	8	1/2mm
11-113	13	mm	11-135	9	1/2mm
11-114	14	mm	11-136	10	1/2mm
11-115	15	mm	11-137	11	1/2mm
11-116	16	mm	11-138	12	1/2mm
11-117	17	mm	11-139	13	1/2mm
11-118	18	mm	11-140	14	1/2mm
11-119	19	mm	11-141	15	1/2mm
11-120	20	mm	11-142	16	1/2mm
11-121	21	mm	11-143	17	1/2mm
11-122	22	mm			



1/2

**11-144 - 152**  
HEGAR  
205 mm

11-144	1+2	mm
11-145	3+4	mm
11-146	5+6	mm
11-147	7+8	mm
11-148	9+10	mm
11-149	11+12	mm
11-150	13+14	mm
11-151	15+16	mm
11-152	17+18	mm

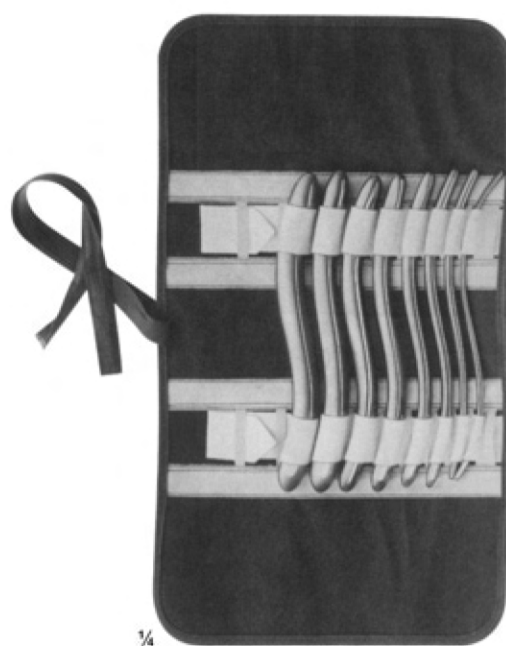

1/4

**11-153**  
HEGAR  
Uterine dilator set, in canvas  
roll with 8 dilators.

# Uterine Probes



**11-154**  
MAYO  
malleable  
330 mm



**11-155**  
SIMS  
malleable  
330 mm



**11-156**  
MARTIN  
330 mm



**11-157**  
SIMPSON  
malleable  
silver-plated  
290 mm



**11-158**  
BRAUN  
Uterine  
depressor  
270 mm



**11-159**  
Cotton  
applicator  
270 mm



# Uterine Dressing Forceps



11-160  
PELKMANN  
260 mm



11-161  
PELKMANN  
260 mm



11-162  
BOZEMANN  
250 mm

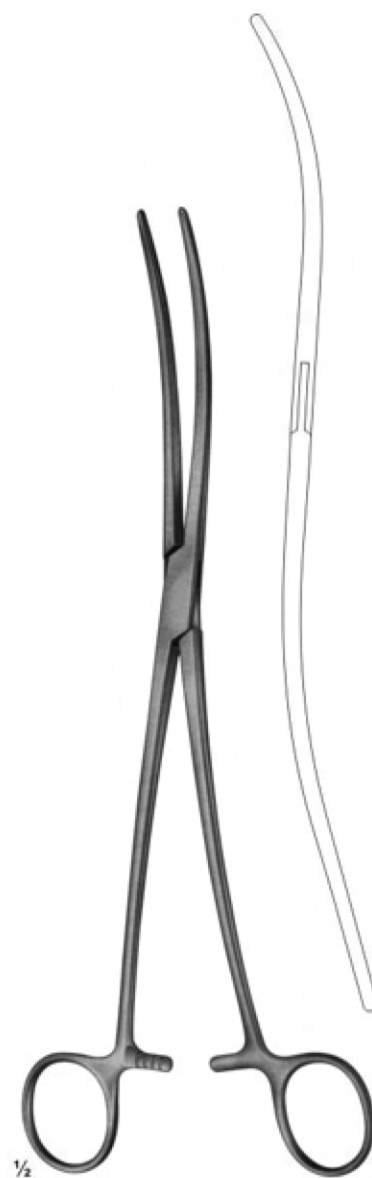

11-163  
BOZEMANN  
255 mm

Jaws with longitudinal groove

## Polypus-and Ovum Forceps

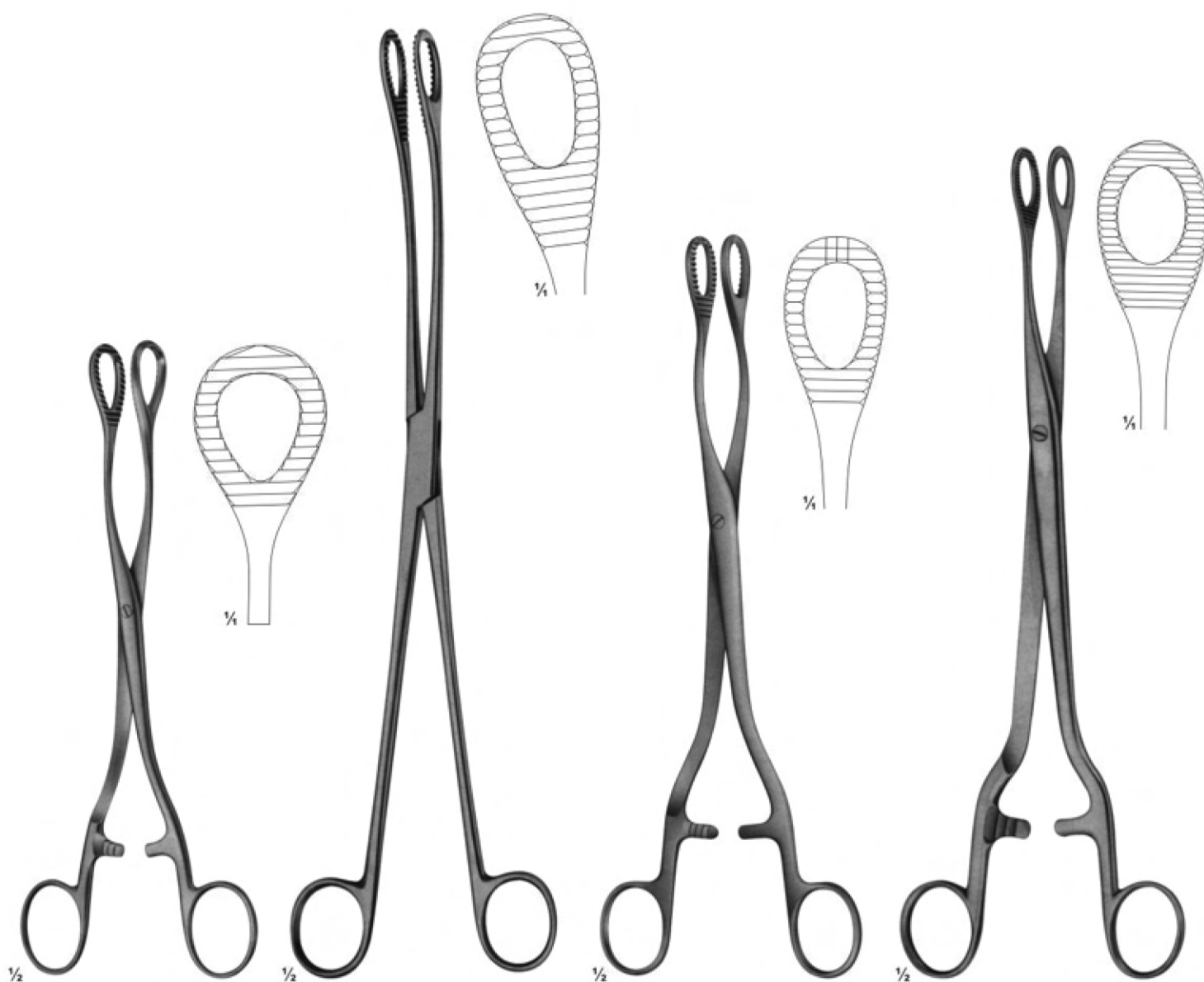

**11-164**  
HEYWOOD-SMITH  
200 mm

**11-165**  
KELLY  
320 mm

**11-166**  
HEYWOOD-SMITH  
250 mm

**11-167**  
NOTO  
280 mm

# Ear Currettes

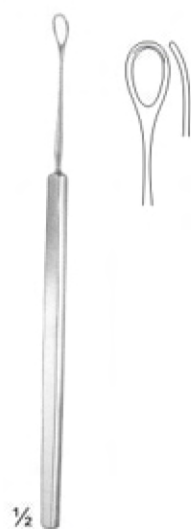

**12-101**  
Langenbeck  
13 cm / 5 1/8"

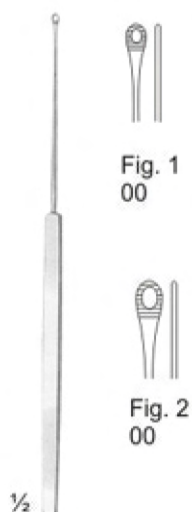

**12-102**  
Shapleigh  
15 cm / 5 1/8"

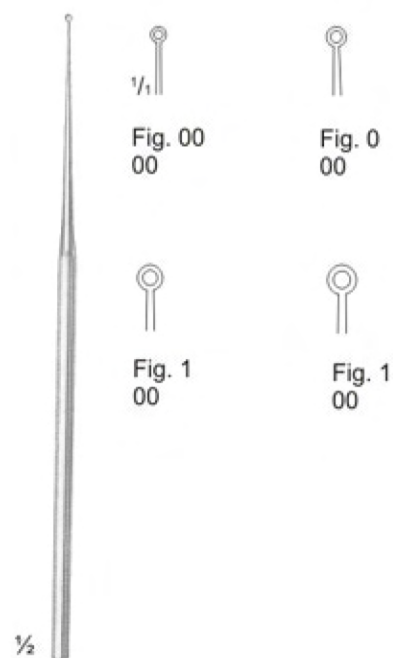

**12-103**  
Buck  
17cm / 6 6/8"



**12-104**  
Buck  
15 cm / 6 6/8"

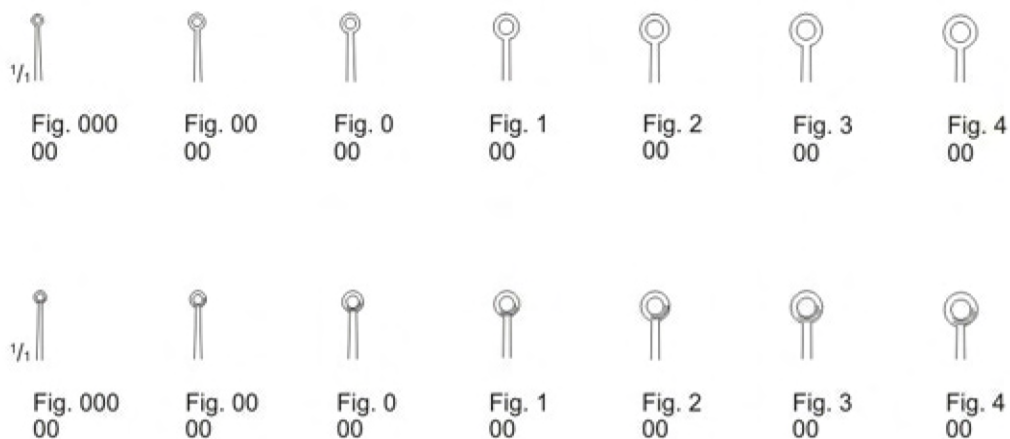

## Biopsy Curettes

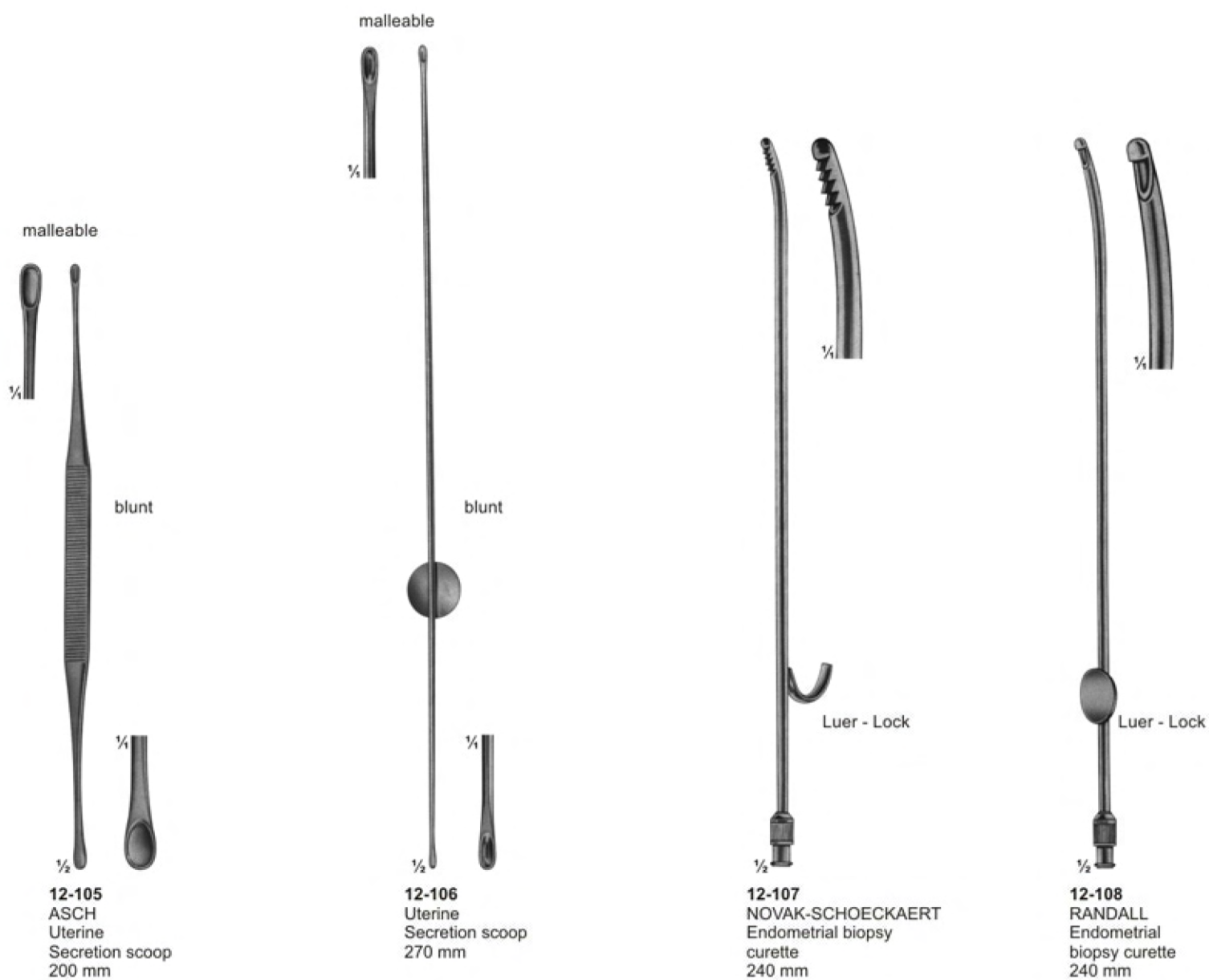



# Ear Polypus Forceps



**12-109**  
Hartmann-Wullstein  
shaft length  
85 mm



**12-110**  
Hartmann-Wullstein  
shaft length  
85 mm



**12-111**  
Hartmann  
shaft length  
85 mm



**12-112**  
Hartmann  
shaft length  
85 mm

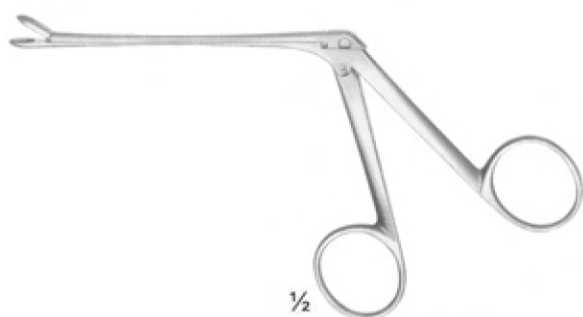

$\frac{1}{2}$   
**12-109 - 12-119**

**12-113**  
14 cm / 5 4/8"  
shaft length  
140 mm

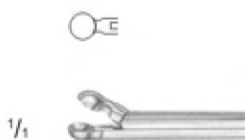

**12-114**  
Hartmann-Herzfeil  
2,0 mm  
shaft length  
85mm

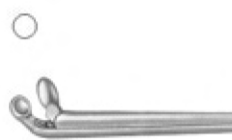

**12-115**  
Hartmann  
3 mm  
shaft length  
85mm

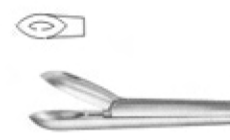

**12-116**  
shaft length  
85mm



**12-117**  
Hartmann-Hoffmar  
2,0 mm  
85mm

**12-118**  
2,5 mm  
85 mm

**12-119**  
3,0 mm  
85 mm

# Biopsy forceps for rectum

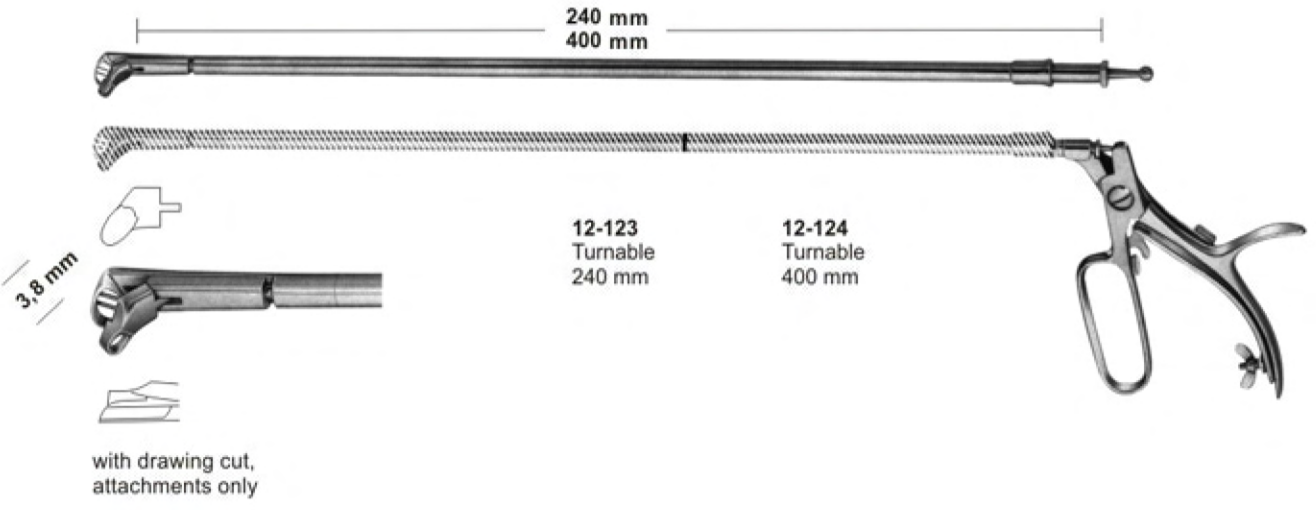
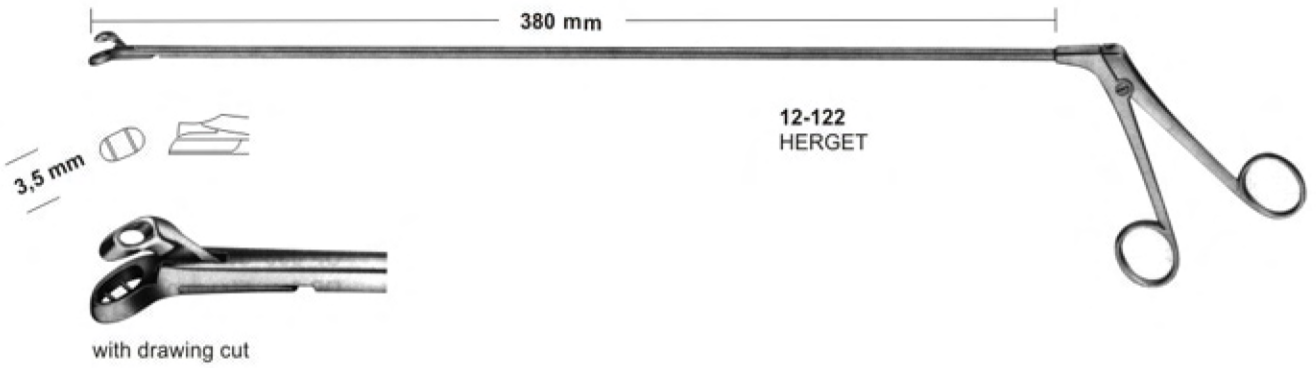
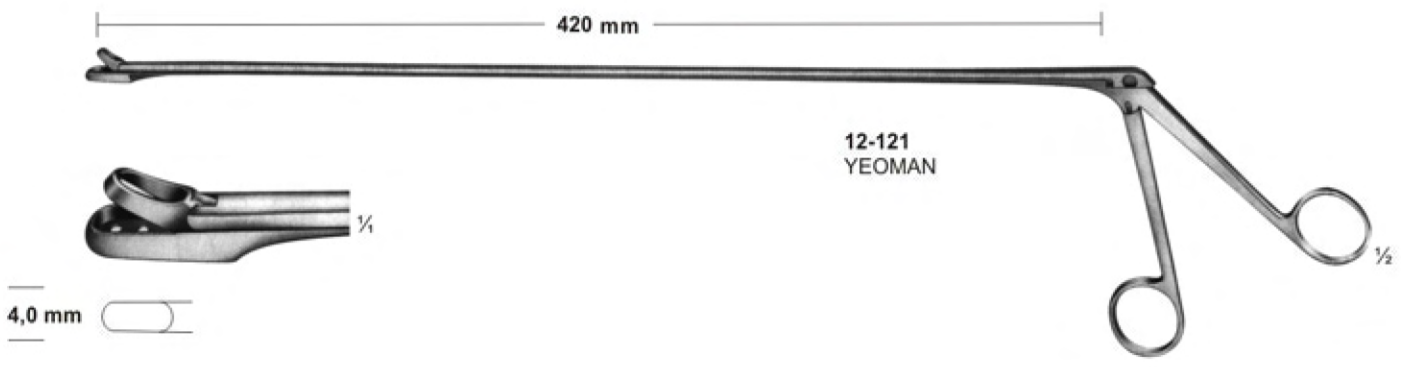
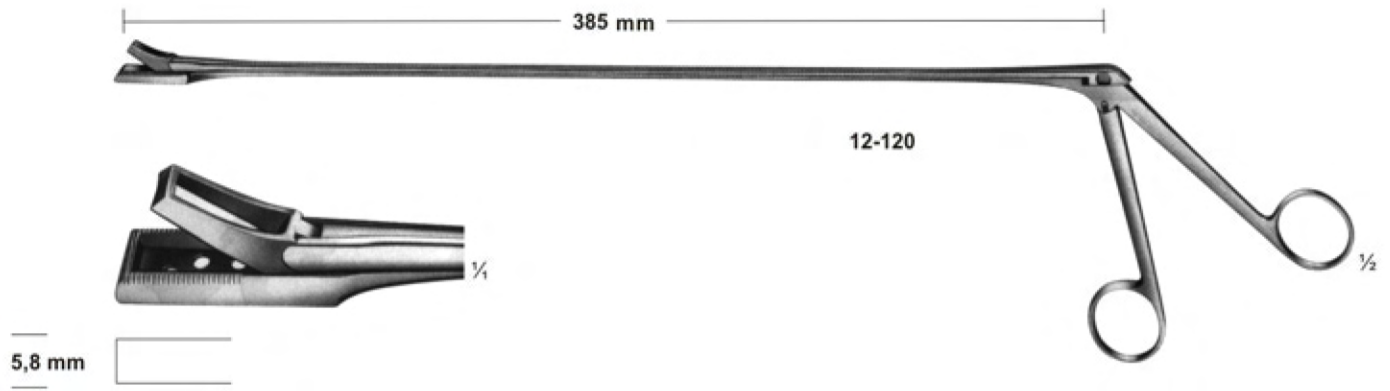

# Biopsy Forceps

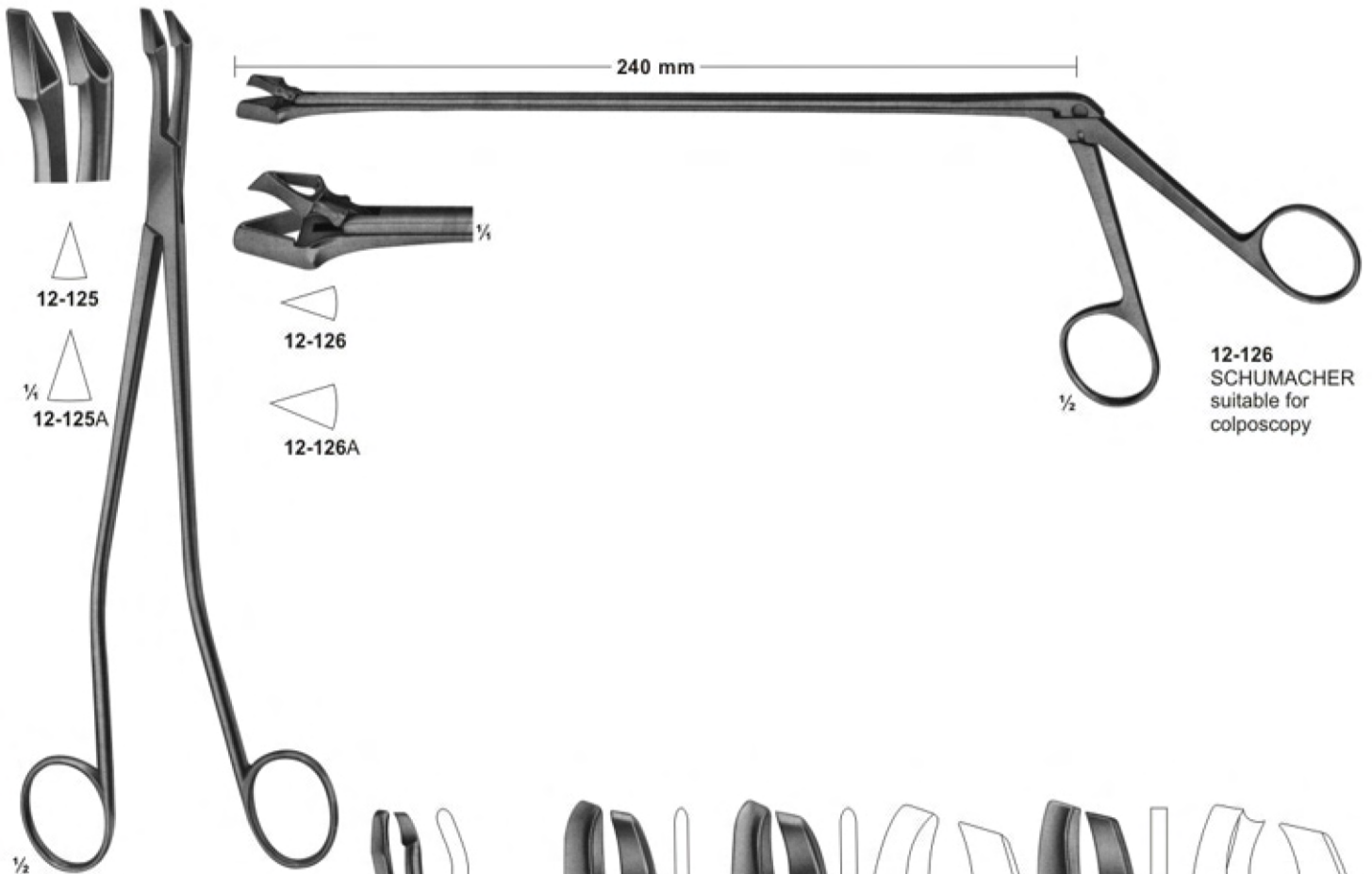

12-125

12-125A

240 mm

12-126

12-126A

12-126 SCHUMACHER suitable for colposcopy

12-125 SCHUMACHER 240mm

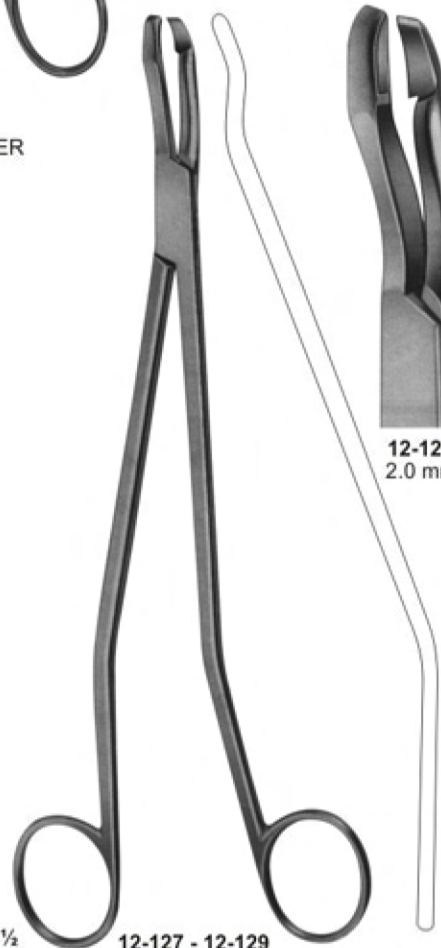

12-127 - 12-129 SEIDL DBP Biopsy forceps, bayonet shaped for portio, vagina and vulva 240mm



12-127 2.0 mm



12-128 2.4 mm



12-129 2.4 mm



# Biopsy Forceps

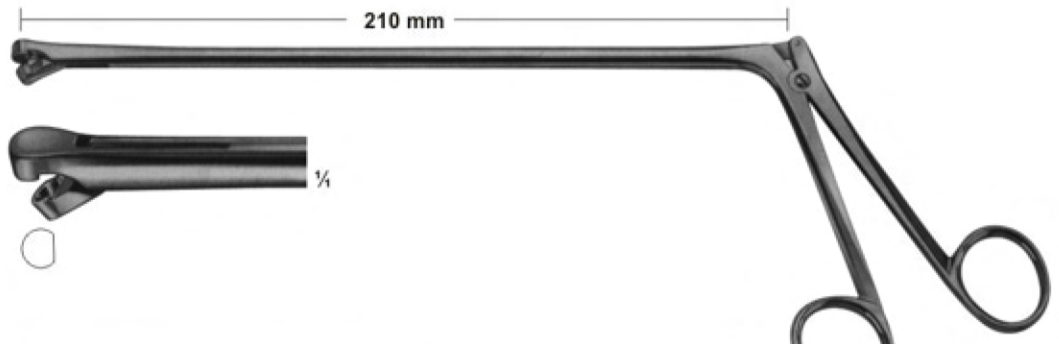

12-130 BERGER

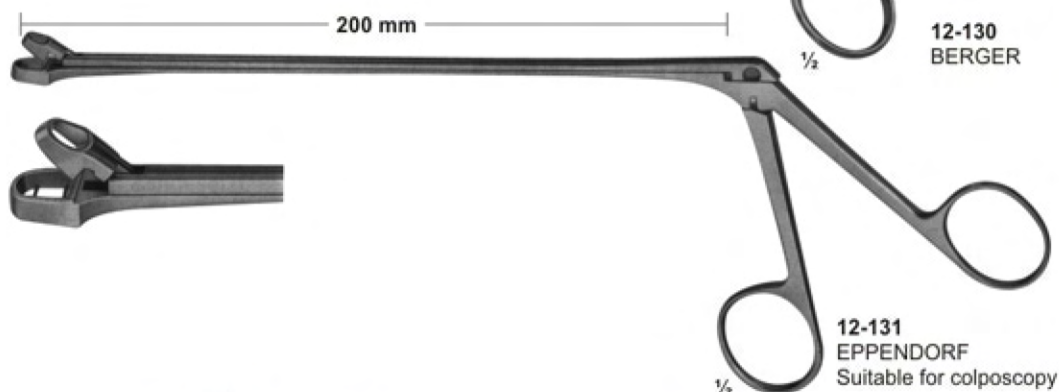

12-131 EPPENDORF Suitable for colposcopy

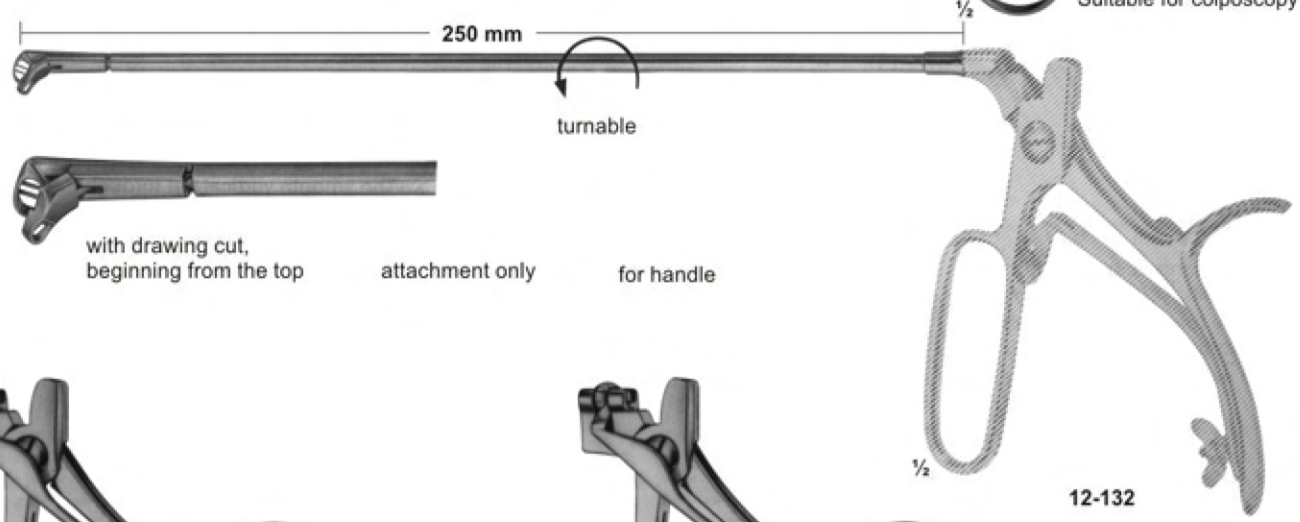

with drawing cut, beginning from the top attachment only for handle

12-132



12-133 AESCULAP 140 mm

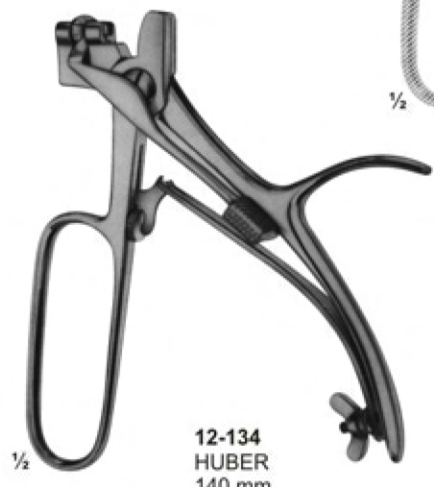

12-134 HUBER 140 mm



Extension cannulae

12-135 BRUENINGS 200 mm Length  
12-136 BRUENINGS 250 mm Length



12-137 12-137A 12-137 KRAUSE ( Biopsy tip )



12-138 SCHEINMANN ( Biopsy tip )



12-139 SCHUMACHER ( Biopsy tip ) with drawing cut



# Uterine Scoops

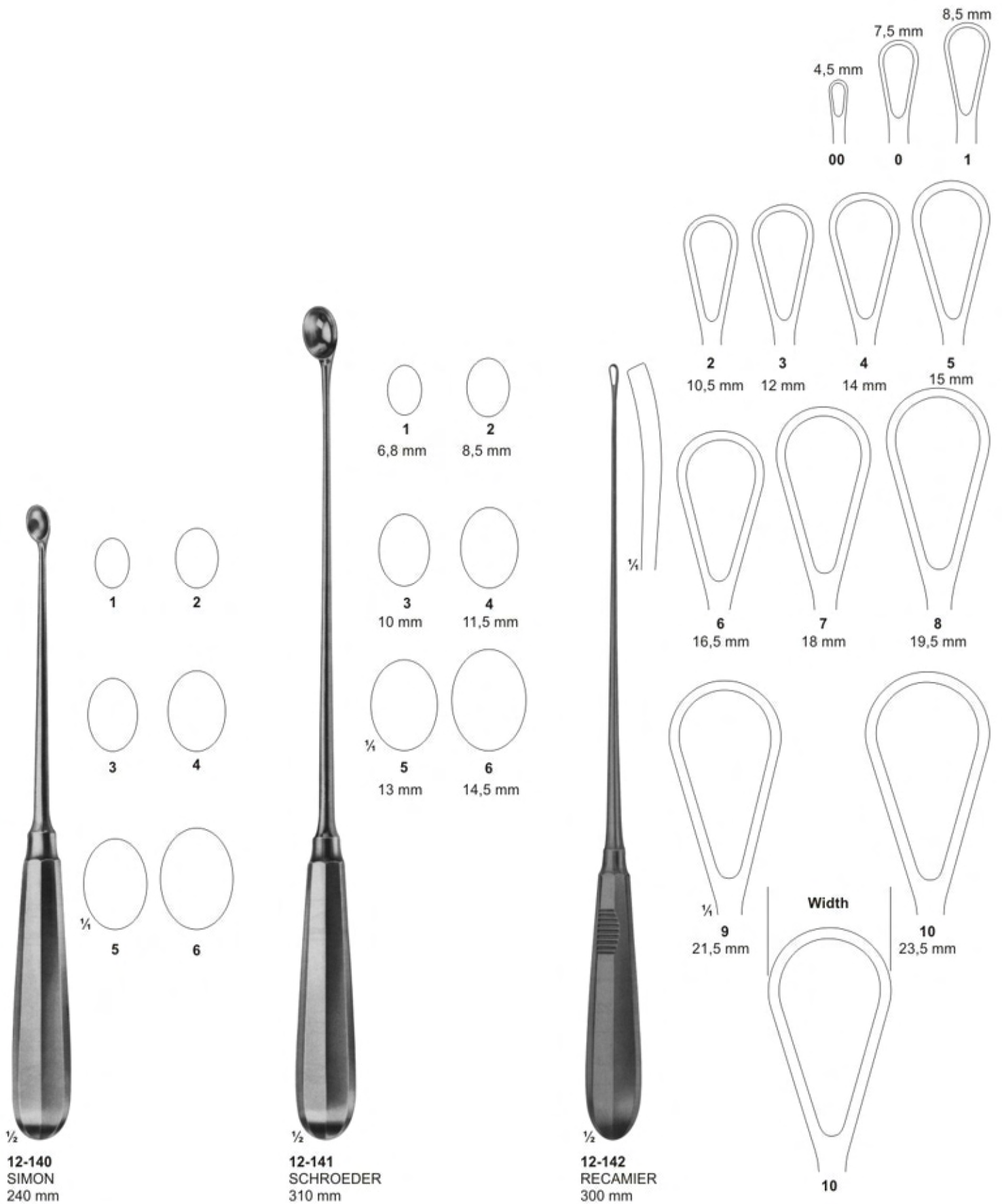

## Obstetrical Forceps

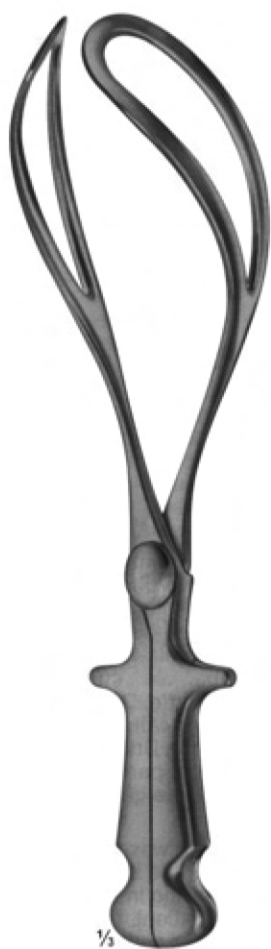

**13-101**  
NAEGELE  
355 mm



**13-102**  
NAEGELE  
400 mm



**13-103**  
SIMPSON-BRAUN  
305mm

# Obstetrics- Placenta and Ovum Forceps

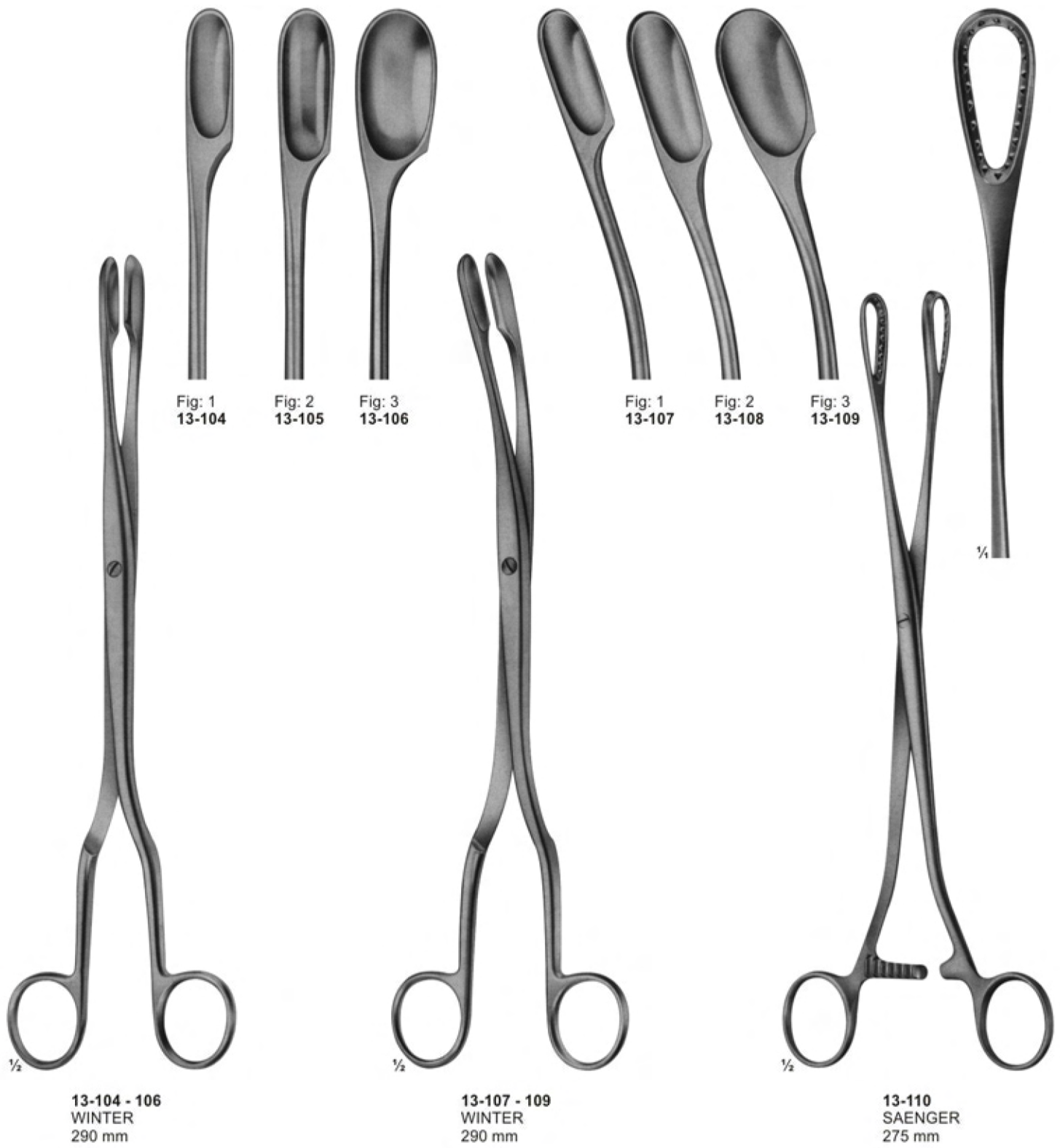

Fig: 1  
13-104

Fig: 2  
13-105

Fig: 3  
13-106

Fig: 1  
13-107

Fig: 2  
13-108

Fig: 3  
13-109

1/2

13-104 - 106  
WINTER  
290 mm

13-107 - 109  
WINTER  
290 mm

13-110  
SAENGER  
275 mm

## Tound-and Tracheal Hooks and Dilators



**13-111**  
BOSE  
165 mm



**13-112**  
BOSE  
165 mm



**13-113 - 115**  
180 mm

**13-113**  
sharp



**13-114**  
blunt



**13-115**  
stumpf/blunt



**13-116**  
FINSEN  
50 mm



**13-117**  
FINSEN  
70 mm



**13-118**  
TROUSSEAU  
120 mm



**13-119**  
LABORDE  
125 mm



**13-120**  
LABORDE  
strong pattern  
135 mm



**13-121**  
Cleaning Brush  
for tracheal tubes  
285 mm



# Vascular Spatulas

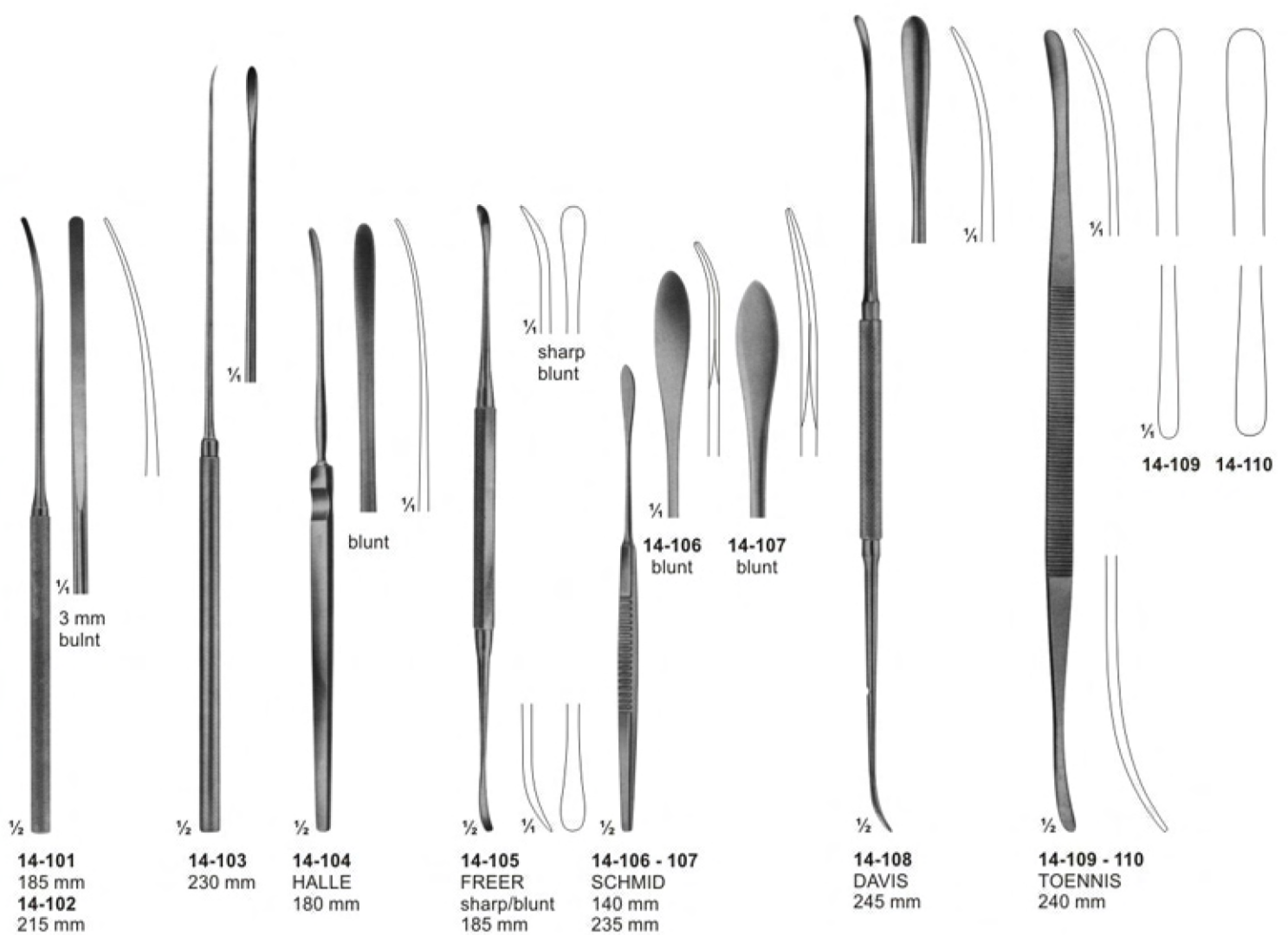

# ATRAUMATA Forceps

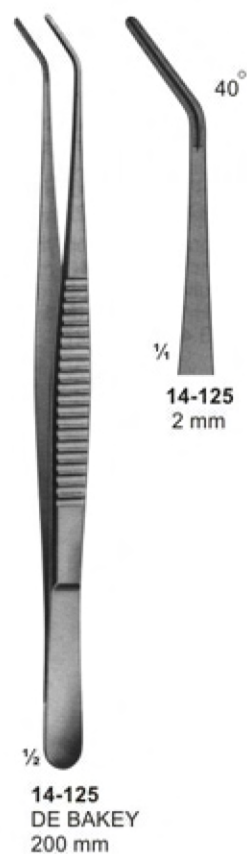
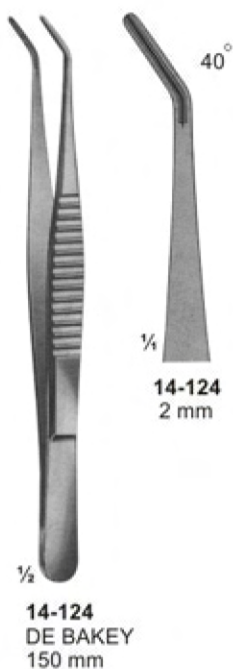
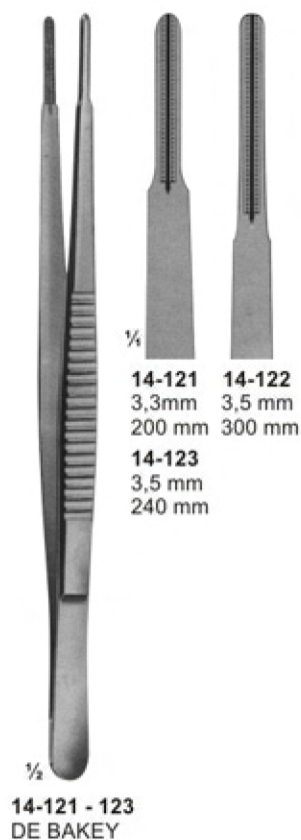
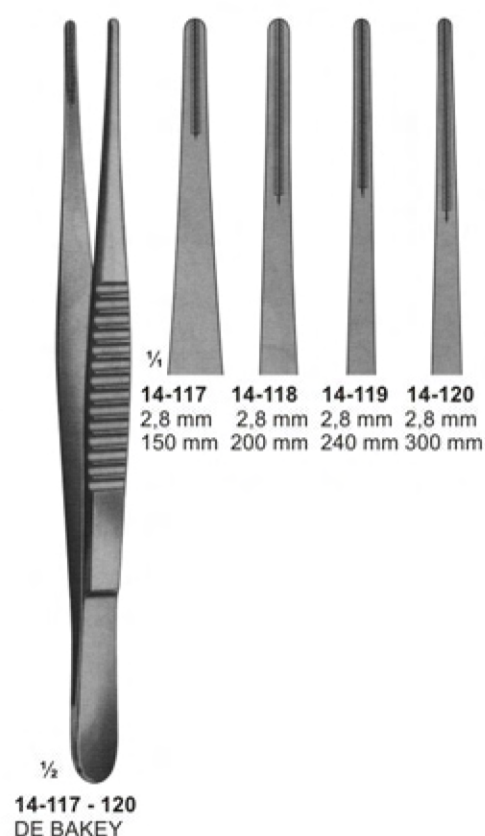
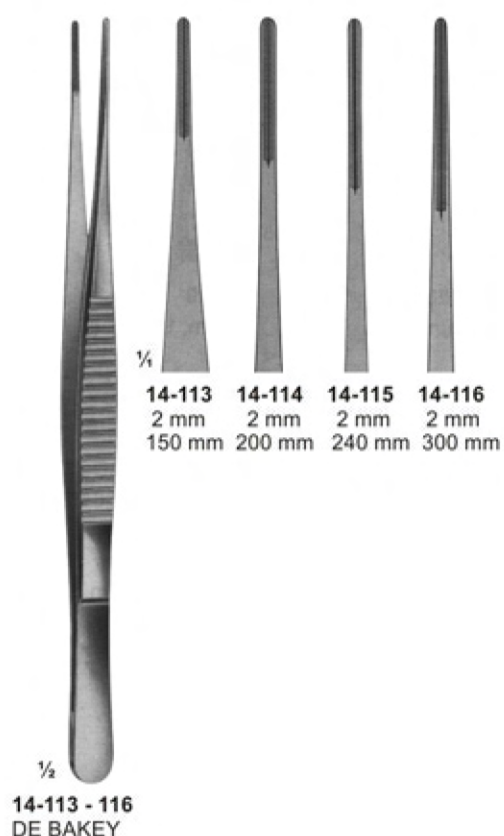
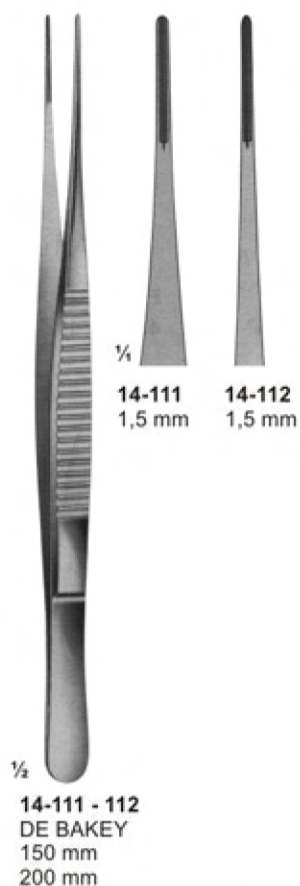

# ATRAUMATA

## Anastomosis- and Multi- Purpose- Clamps- Pediatric types

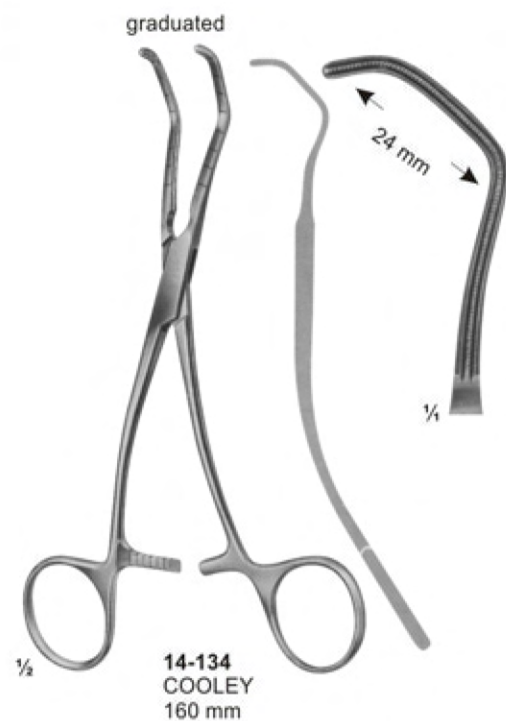
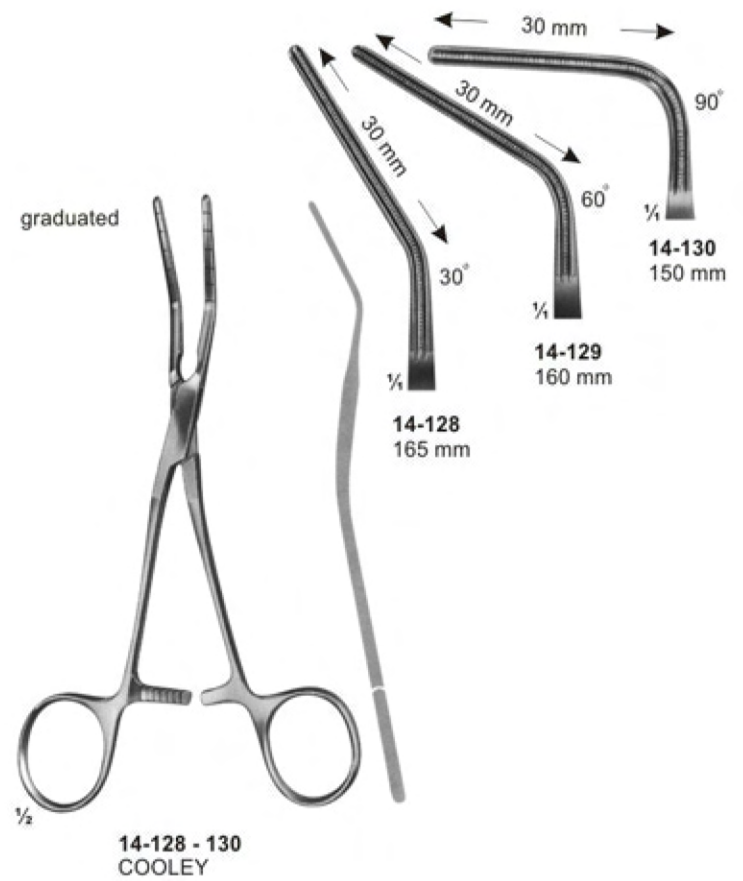
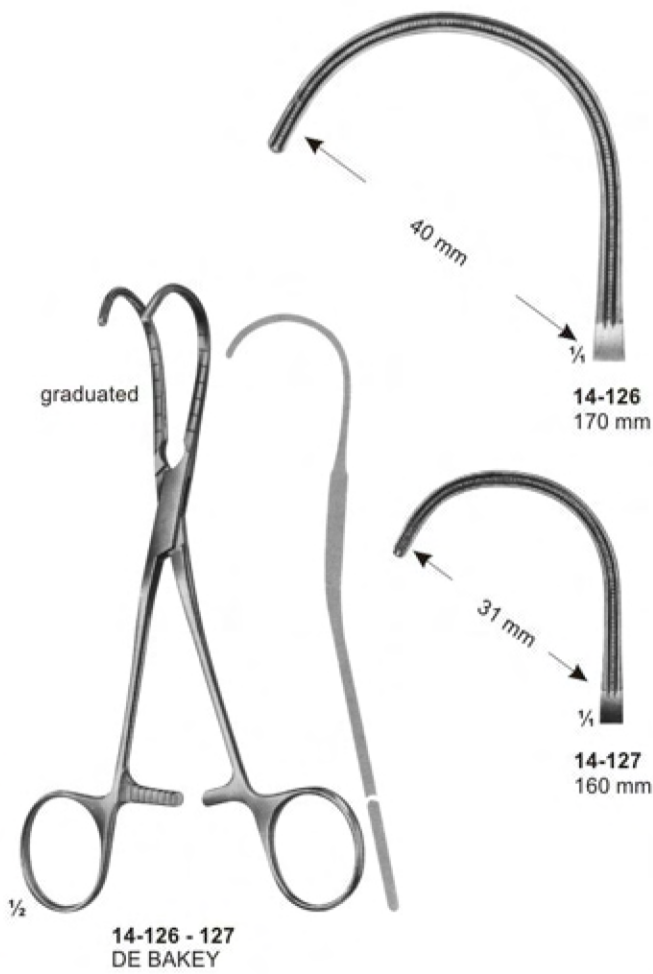

# ATRAUMATA

## Coarctation Clamps, Patent-Ductus & Peripheral-Vascular Clamps

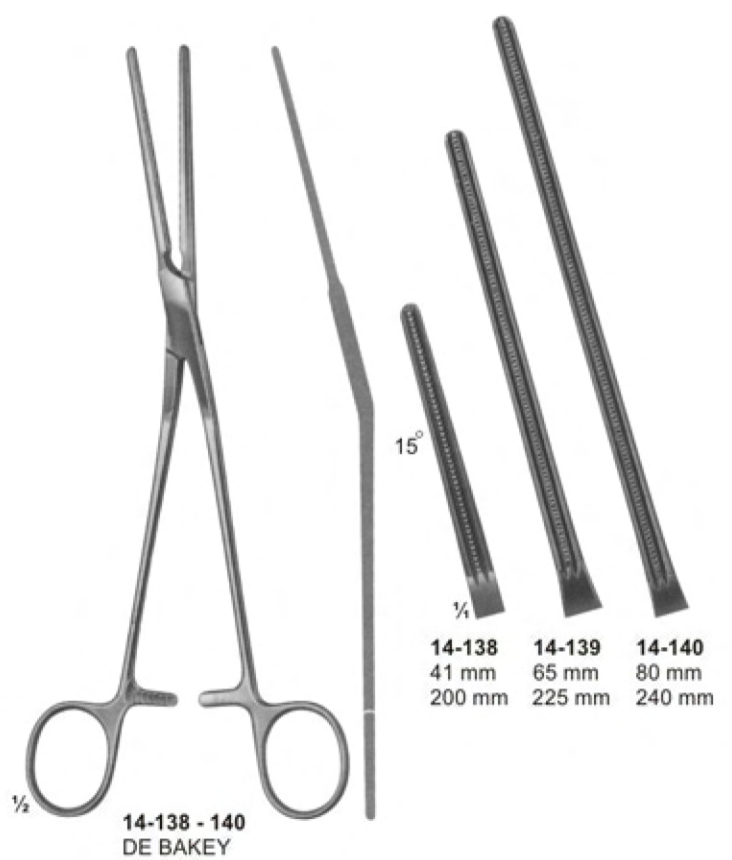
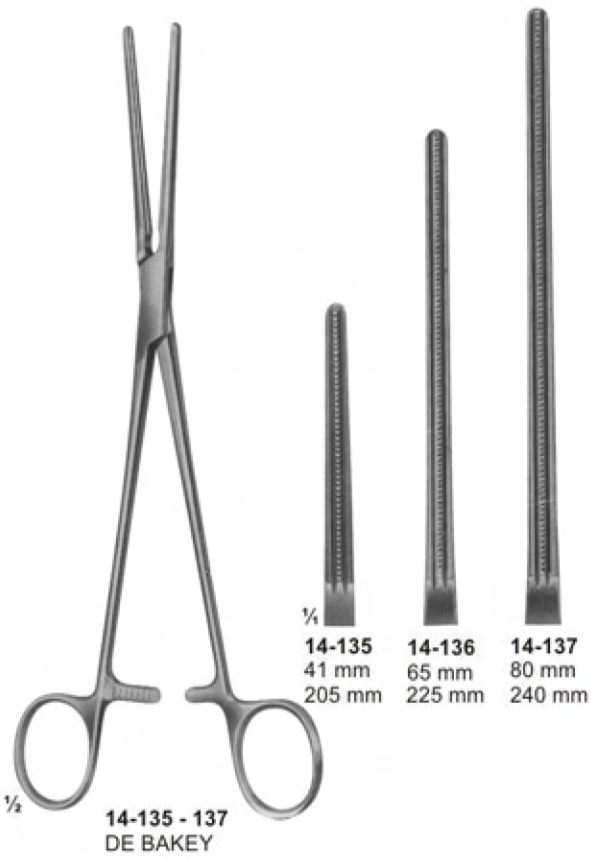



## Aorta- Anastomosis Clamps



**L**  
**14-144**  
WEBER  
260 mm



**R**  
**14-145**  
WEBER  
260 mm

# Multi- Purpose-Clamps



1/2 **14-146 - 149**  
DE BAKEY

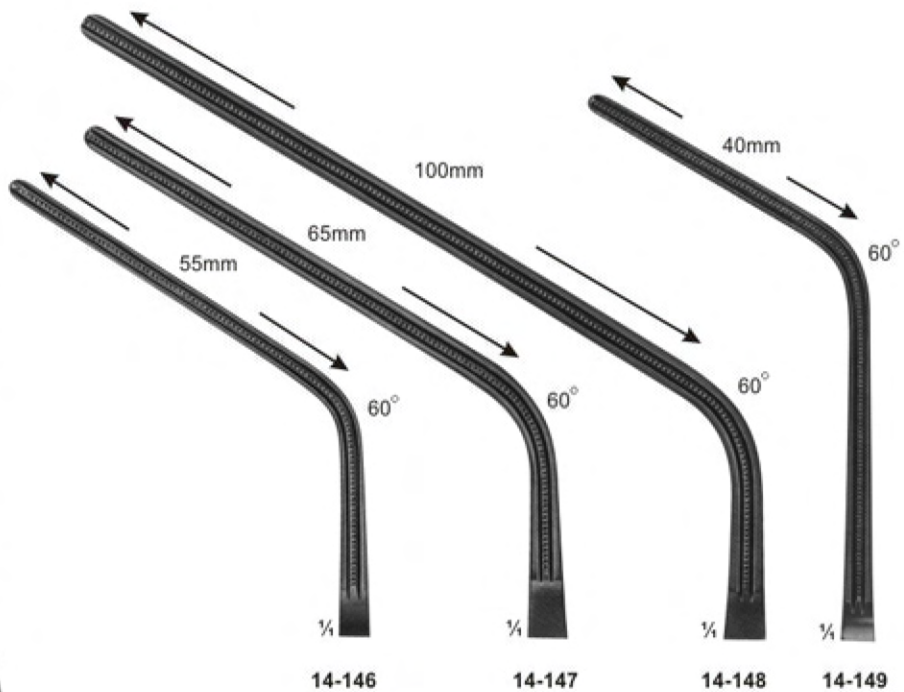

Total Length:	230 mm	280 mm	305 mm	240 mm
Length of jaws:	85 mm	100 mm	135 mm	93 mm



1/2 **14-150 - 153**  
DE BAKEY

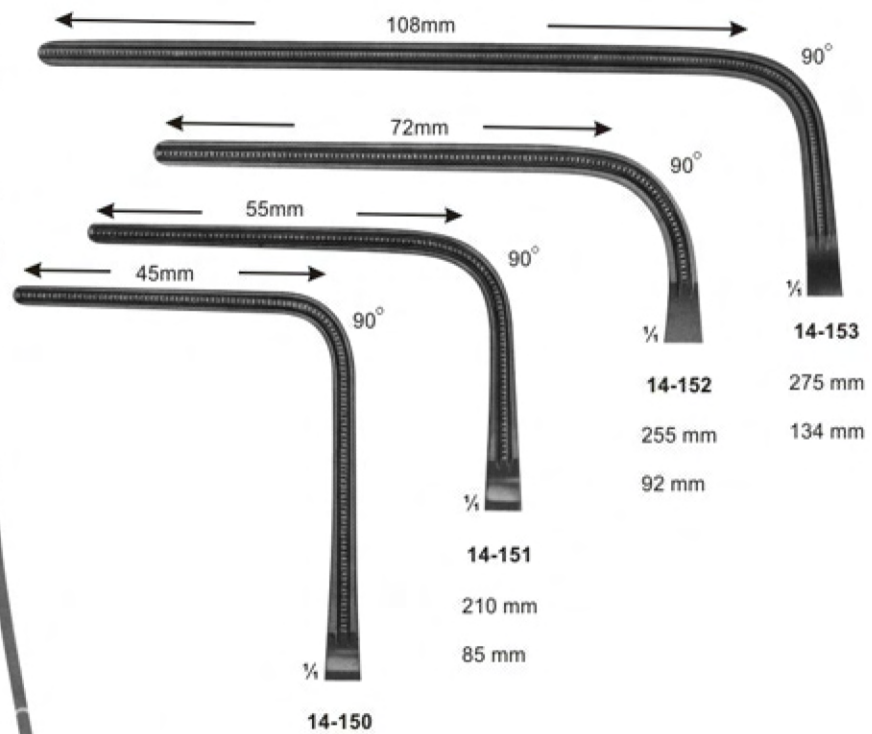

Total Length:	225 mm
Length of jaws:	93 mm

## Sternum Instruments and Rib Shears



**14-154**  
SCHUMACHER  
Sternum shears  
210 mm



**14-155**  
LEBSCHKE  
Sternum chisel  
200 mm



**14-156**  
230 mm



**14-157**  
COLLIN  
195 mm



**14-158**  
GLUCK  
190 mm



**14-159**  
BETHUNE  
340 mm



**14-160**  
BRUNNER  
Universal pattern  
340 mm



**14-161**  
GIERTZ-STILLE  
250 mm

# Rib Spreaders

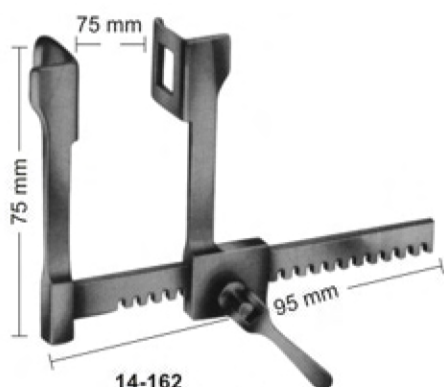

**14-162**  
FINOCHIETTO  
Blades  
18X21 mm

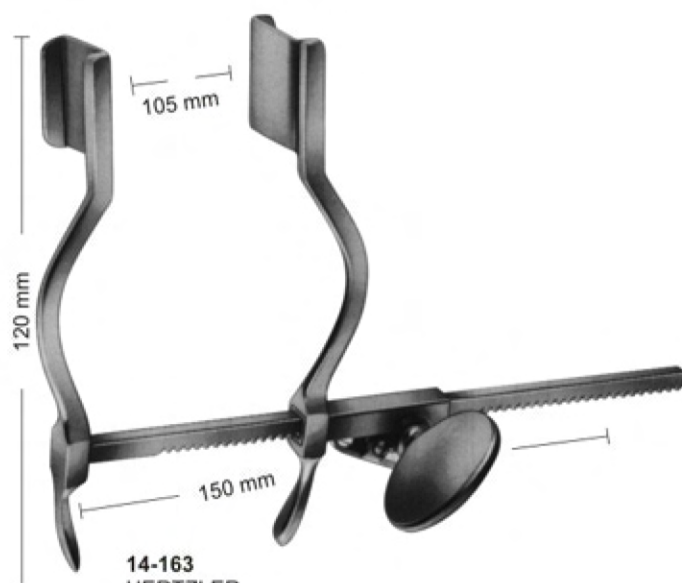

**14-163**  
HERTZLER  
Blades  
20X25 mm

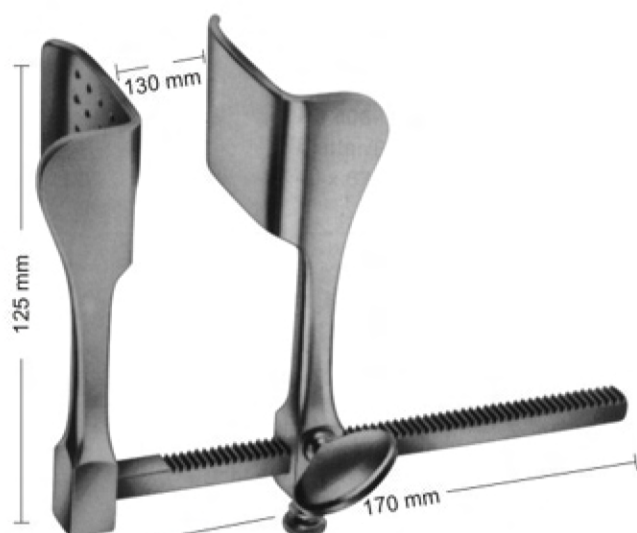

**14-164**  
TUFFIER  
Blades  
43X53 mm

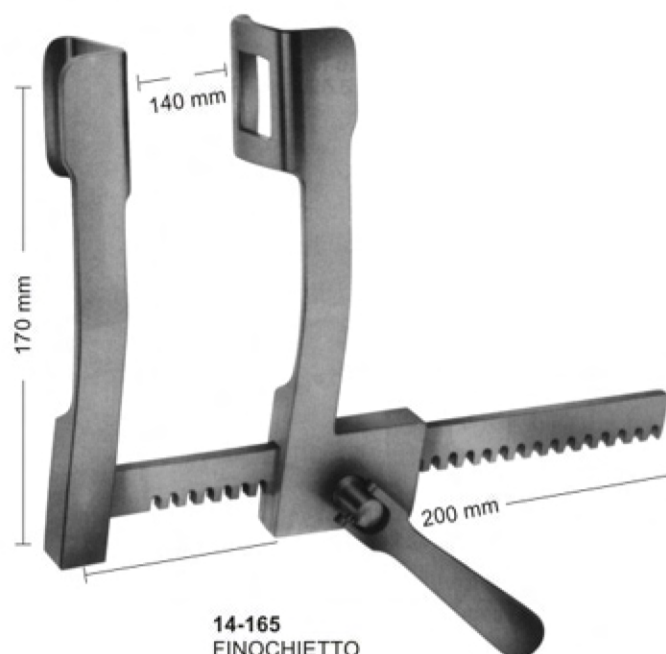

**14-165**  
FINOCHIETTO  
Blades  
36X45 mm



## Rib Spreaders-and Contractors



14-166  
SELLORS  
Rib spreader-and contractor  
with swivel blades  
200 mm



14-167  
BAILEY  
150 mm



14-168  
for children

14-169  
for adults

14-168 - 169  
BAILEY  
200 mm

# Punches

**130°** upwards cutting

**15-101**  
1 mm

KERRISON - JACOBY

FERRIS-SMITH-KERRISON

**15-102**  
2 mm

**15-103**  
3 mm

**15-104**  
4 mm

**15-105**  
5 mm

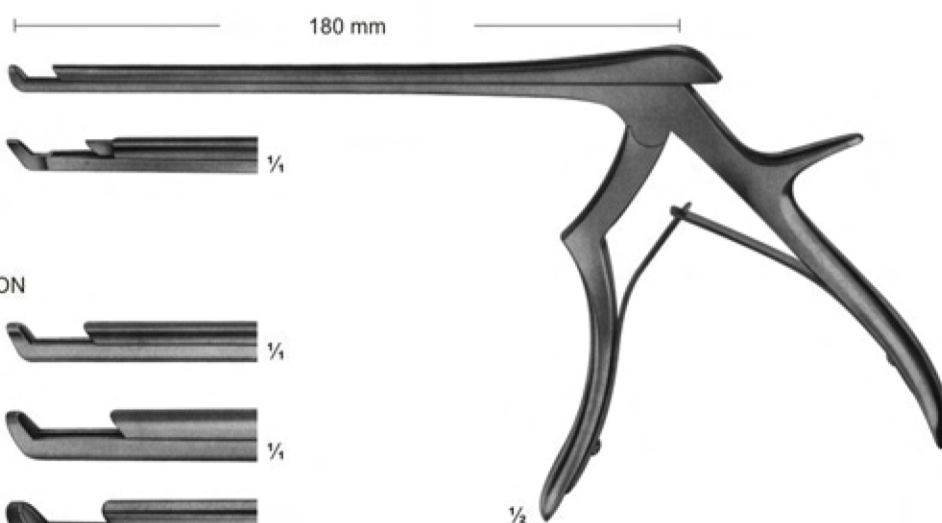

15-101 - 105

**90°** upwards cutting

KERRISON - JACOBY

**15-106**  
1 mm

**15-107**  
2 mm

FERRIS-SMITH-KERRISON

**15-108**  
3 mm

**15-109**  
4 mm

**15-110**  
5 mm

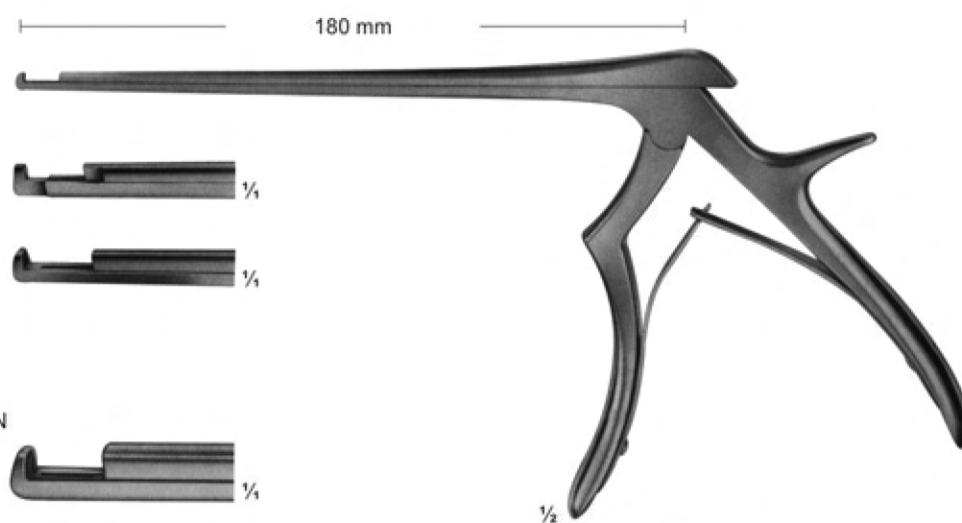

15-106 - 110

# Punches

90° upwards cutting

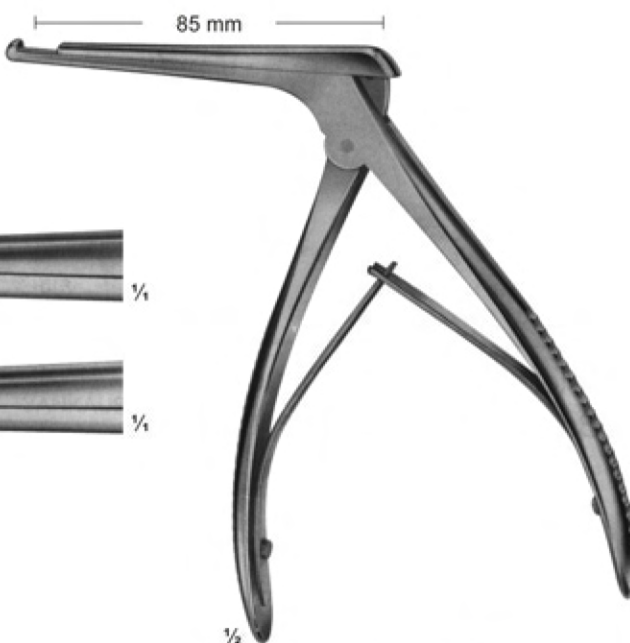

15-111  
4 mm



1/4

15-112  
5 mm



1/4

15-111 - 15-112  
KERRISON

90° upwards cutting

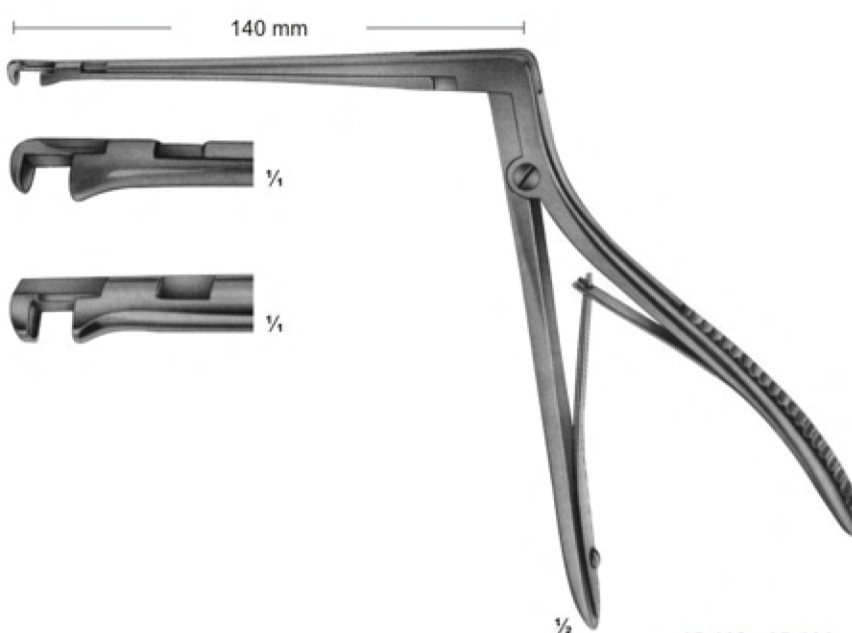

15-113  
3,3 mm



1/4

15-114  
4,0 mm



1/4

15-113 - 15-114  
HAJEK-KOFLER

# Rongeurs

LOVE-GRUENWALD

15-115  
2 X 10 mm



15-116  
3 X 10 mm



SPURLING  
15-117  
4 X 10 mm

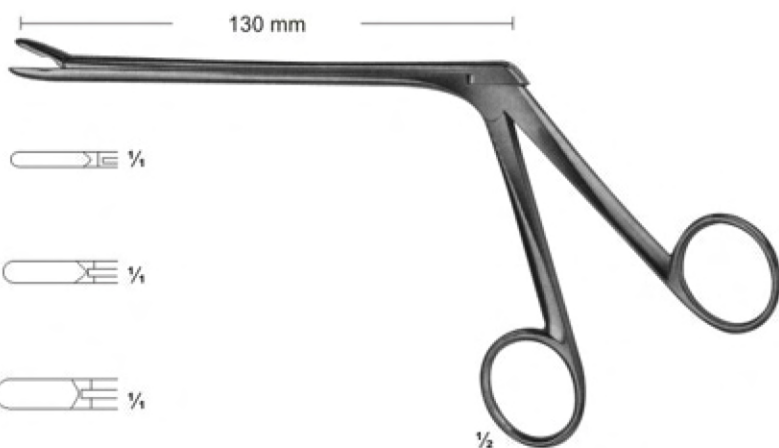

15-115 - 15-117

15-118  
2 mm



15-119  
3 mm



15-120  
4 mm



15-121  
5 mm

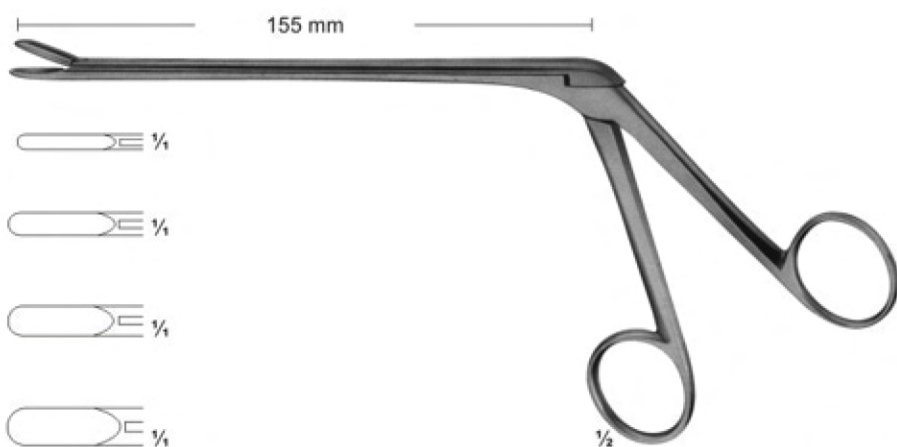

15-118 - 15-121  
CASPAR

150°

15-122  
2 mm



15-123  
3 mm



15-124  
4 mm

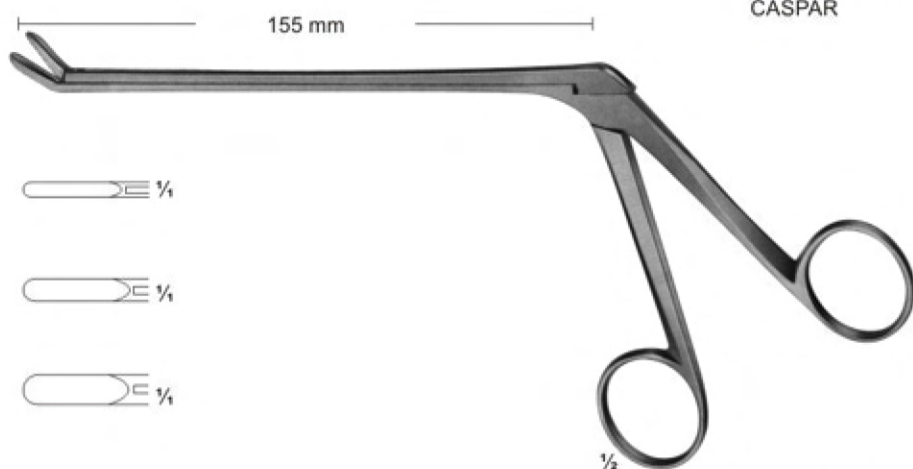

15-122 - 15-124  
CASPAR



# Rongeurs

Angled positions for rongeurs

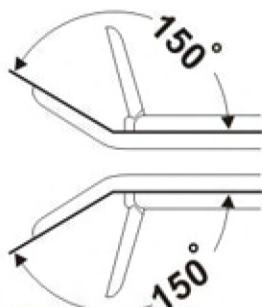

15-125  
3,0 mm

15-126  
3,6 mm

15-127  
4,2 mm

15-128  
4,8 mm

15-129  
5,8 mm

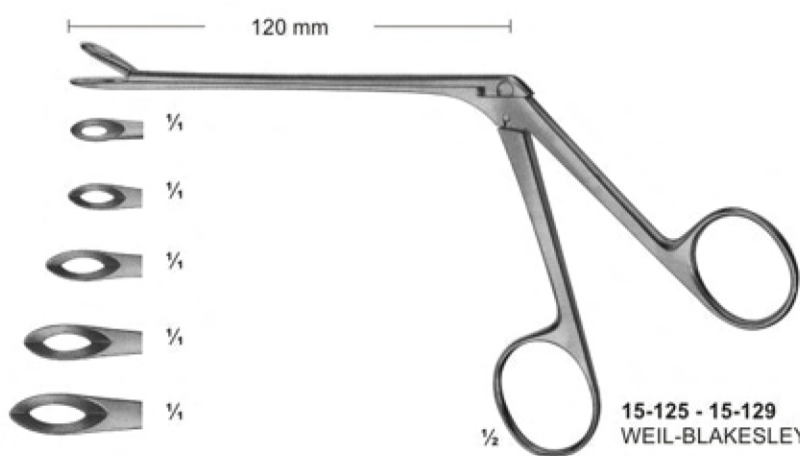
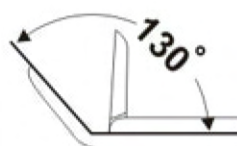
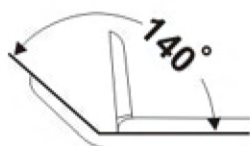

15-125 - 15-129  
WEIL-BLAKESLEY

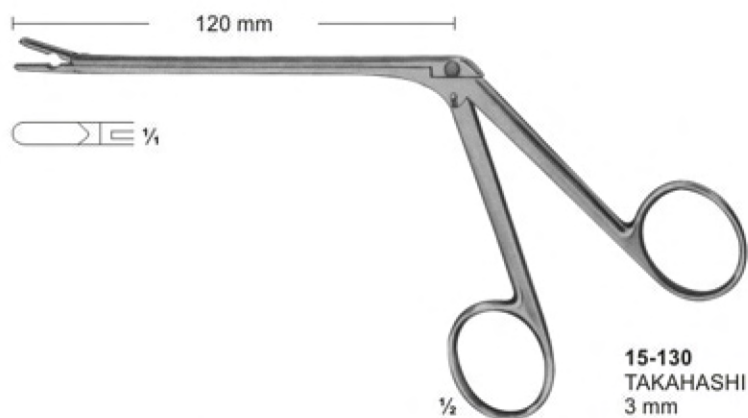

15-130  
TAKAHASHI  
3 mm

130°

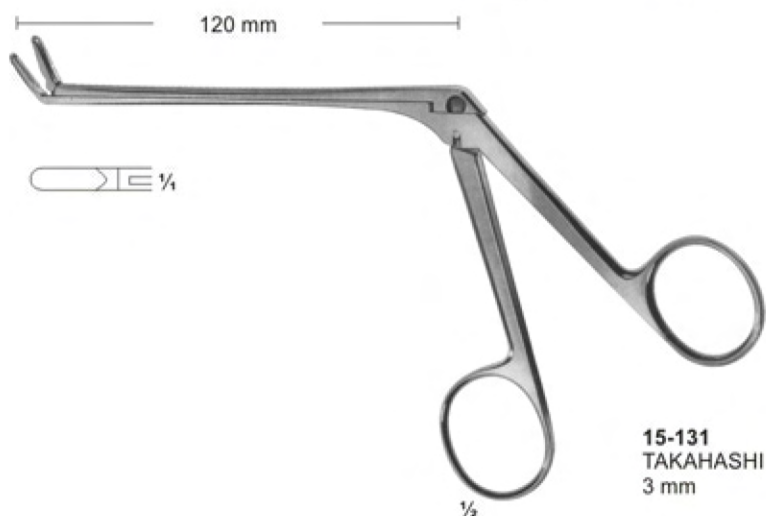

15-131  
TAKAHASHI  
3 mm

# Rongeurs

**150°**

Lower part of jaws movable

**15-132**  
2 mm

**15-133**  
3 mm

**15-134**  
4 mm

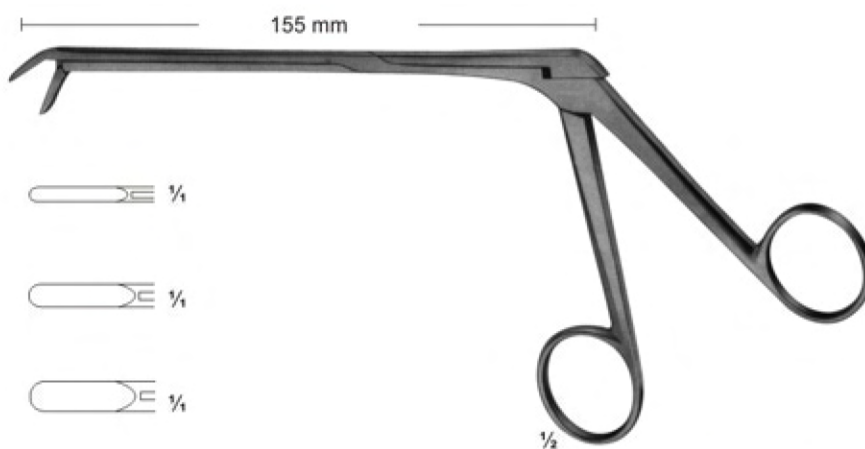

**15-132 - 15-134**  
CASPAR

Length of shaft 140 mm	Length of shaft 160 mm	Length of shaft 185 mm	size of jaws
<b>15-135</b>	<b>15-140</b>	<b>15-145</b>	2 X12 mm
<b>15-136</b>	<b>15-141</b>	<b>15-146</b>	3 X12 mm
<b>15-137</b>	<b>15-142</b>	<b>15-147</b>	4 X14 mm
<b>15-138</b>	<b>15-143</b>	<b>15-148</b>	5 X14 mm
<b>15-139</b>	<b>15-144</b>	<b>15-149</b>	6 X16 mm

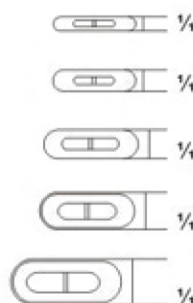

**15-135 - 15-149**  
CASPAR

**150°**

Length of shaft 140 mm	Length of shaft 160 mm	Length of shaft 185 mm	size of jaws
<b>15-150</b>	<b>15-153</b>	<b>15-156</b>	3 X12 mm
<b>15-151</b>	<b>15-154</b>	<b>15-157</b>	4 X14 mm
<b>15-152</b>	<b>15-155</b>	<b>15-158</b>	5 X14 mm

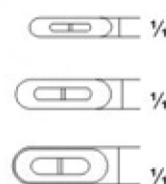

**15-150 - 15-158**  
CASPAR

# Rongeurs

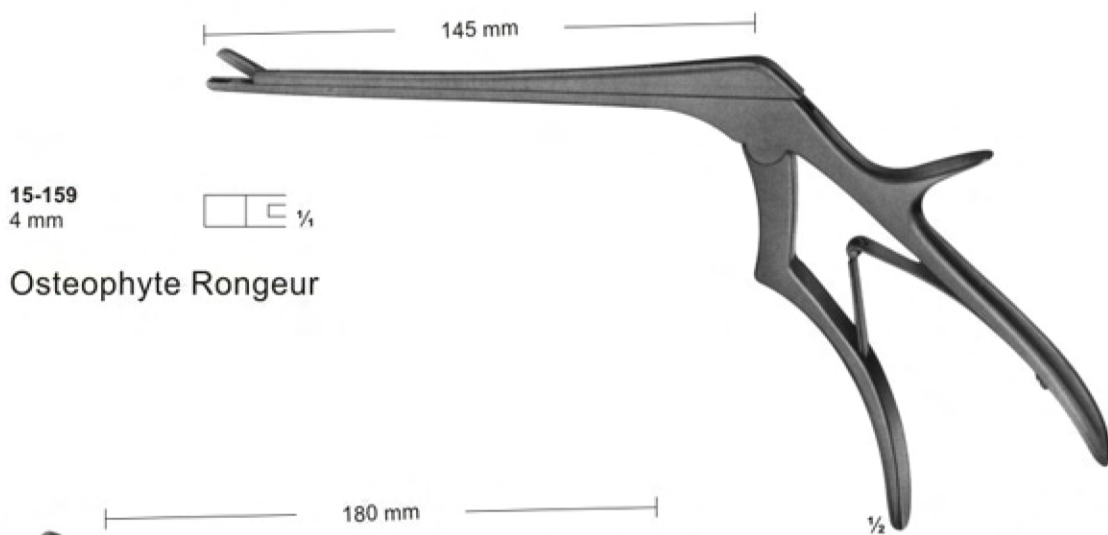

15-159  
CASPAR

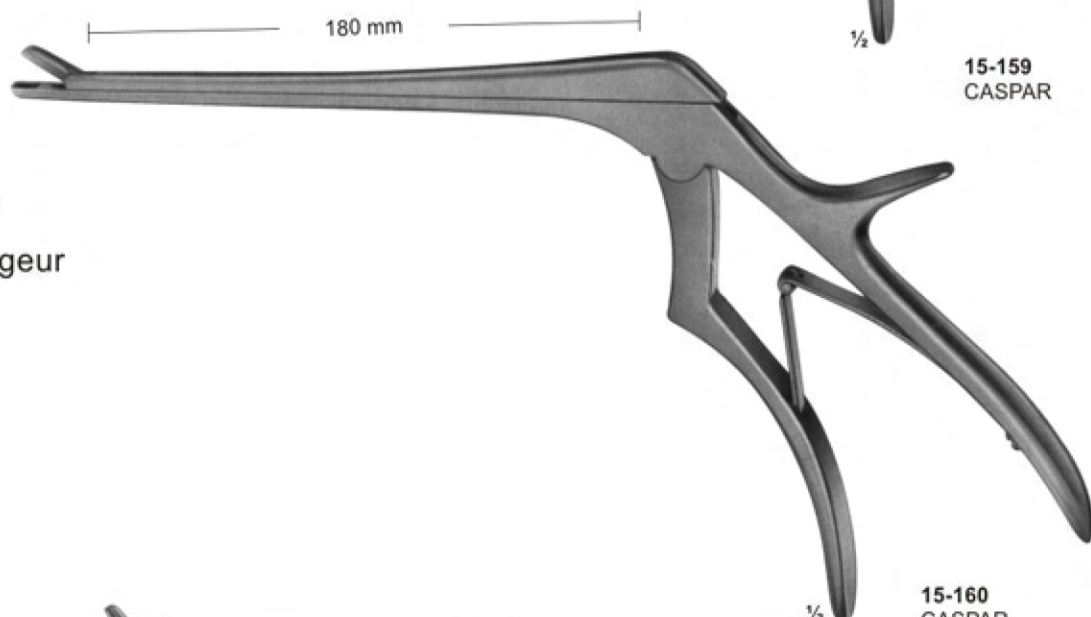

15-160  
CASPAR

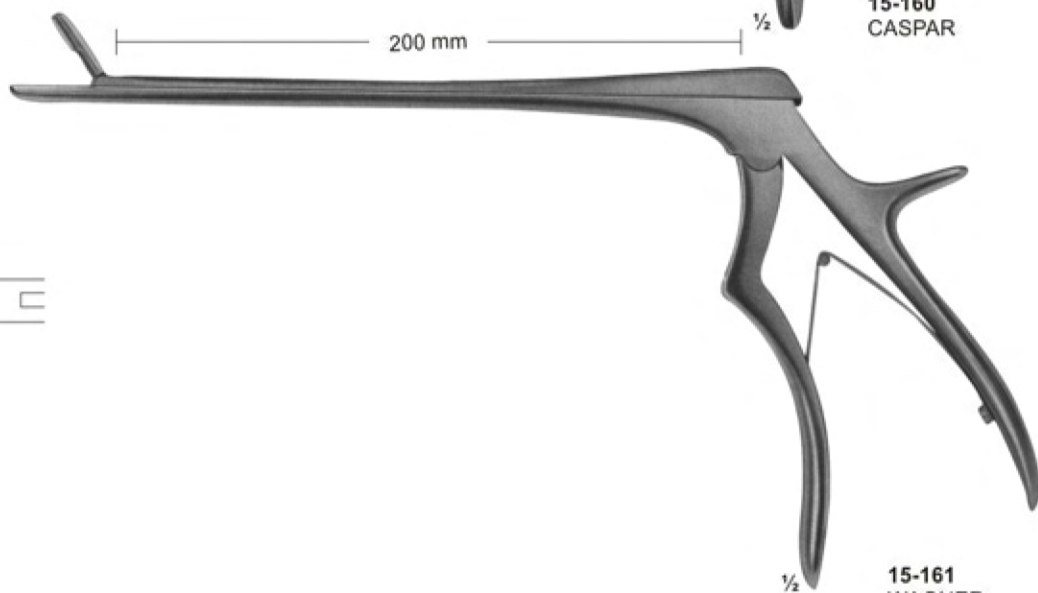

15-161  
WAGNER

# Elevators and Bone Levers

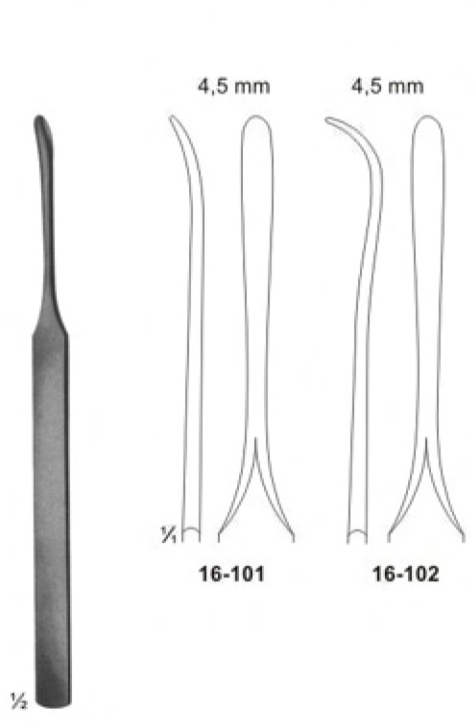

**16-101 - 102**  
KONIG  
155 mm

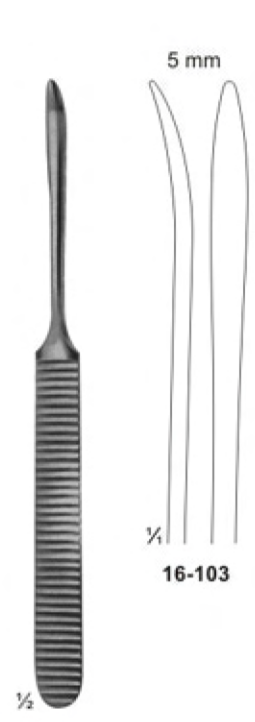

**16-103**  
WILLIGER  
165 mm

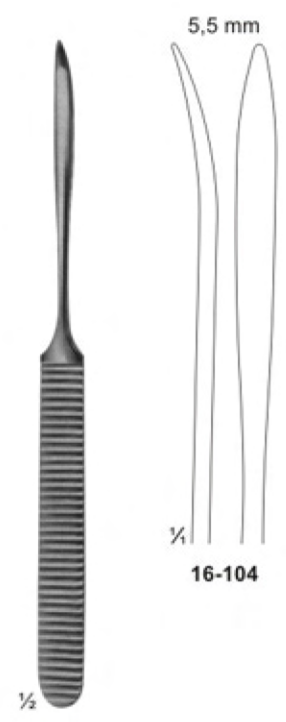

**16-104**  
WILLIGER  
170 mm

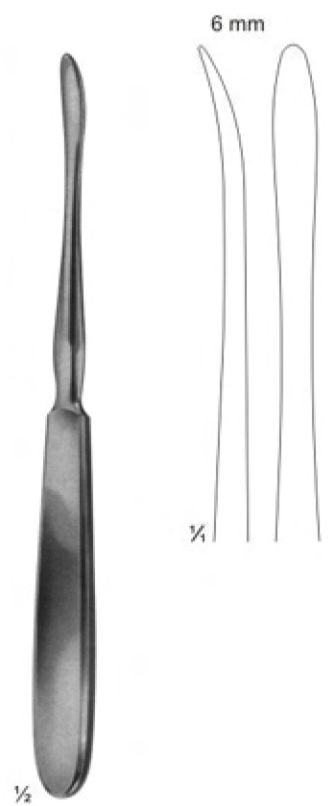

**16-105**  
QUERVAIN  
195 mm

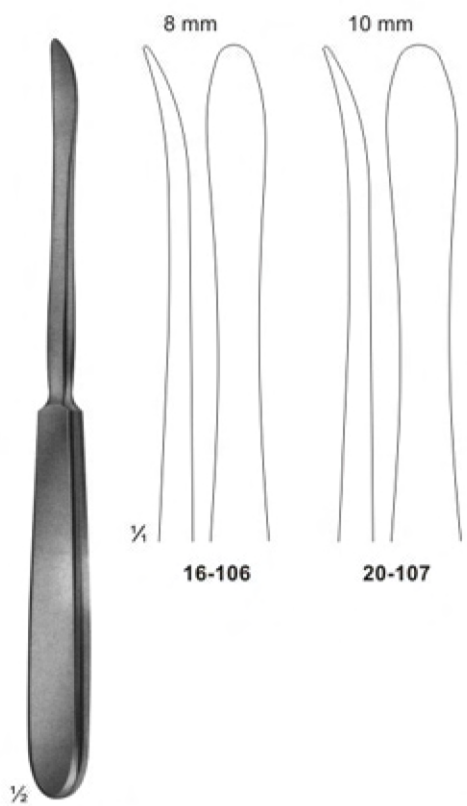

**16-106 - 107**  
LANGENBACK  
195 mm

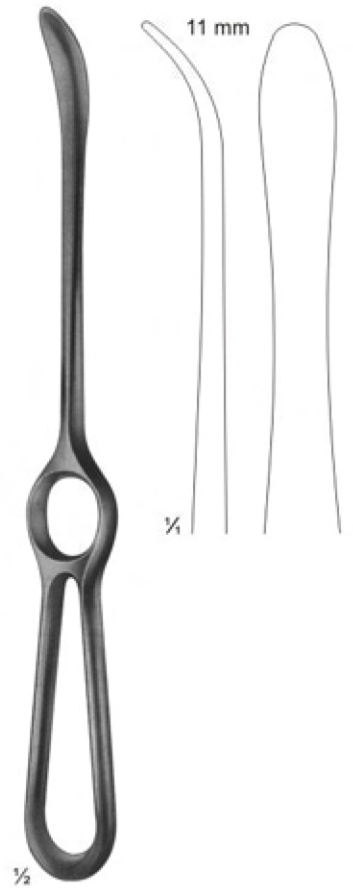

**16-108**  
LANGENBACK  
230mm



# Bone Levers



1/2  
**16-109**  
LANE TRETHOWAN  
215mm

1/2  
**16-110**  
LANE  
255mm

1/2  
**16-111**  
LANE-HOHMANN  
250mm

1/2  
**16-112 - 113**  
LANE-HOHMANN modif.  
**16-112** 265mm  
**16-113** 280mm

16-112  
30 mm  
16-113  
33 mm

# Raspatories



**16-114**  
PARTSCH  
150 mm

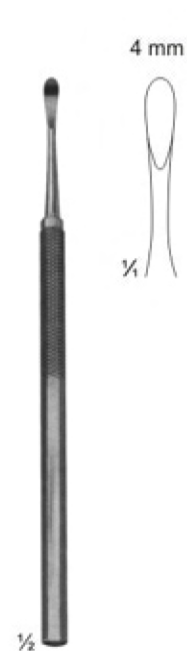

**16-116**  
PARTSCH mod. LANGE  
145 mm

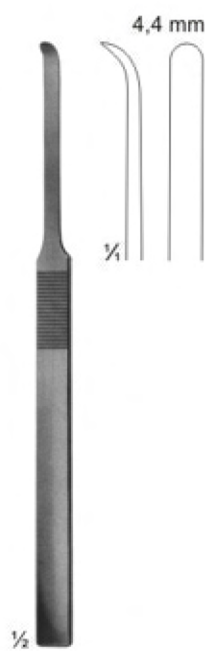

**16-117**  
MC KENTY  
155 mm

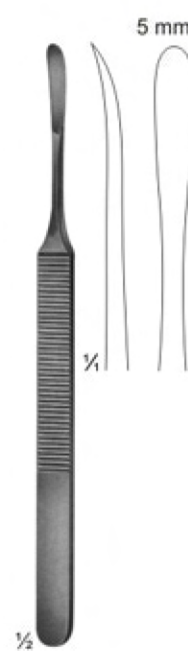

**16-118**  
KOENIG  
155 mm

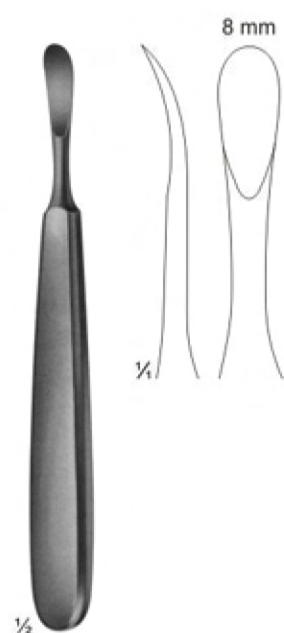

**16-119**  
TRELAT  
150 mm

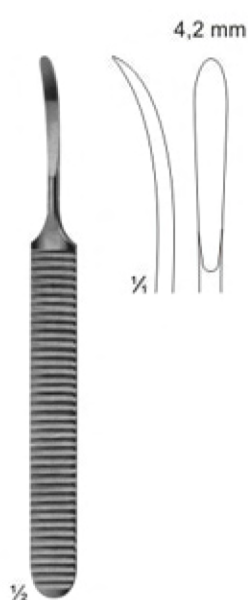

**16-120**  
WILLIGER  
140 mm

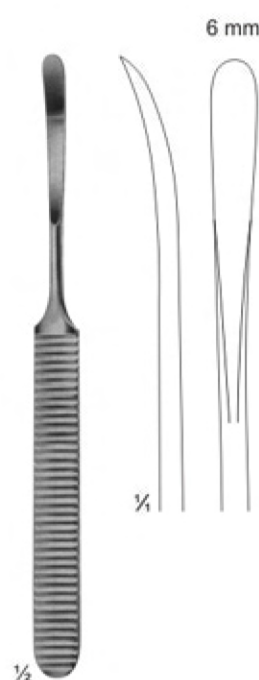

**16-121**  
WILLIGER  
160 mm

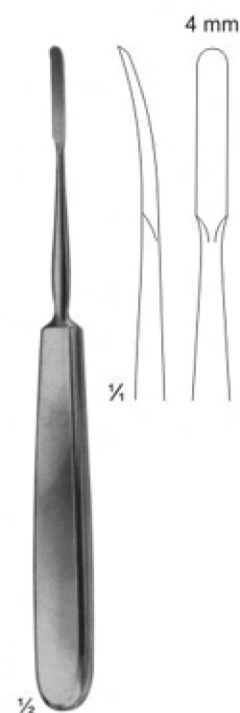

**16-122**  
JOSEPH  
170 mm

# Bone File and Rasps

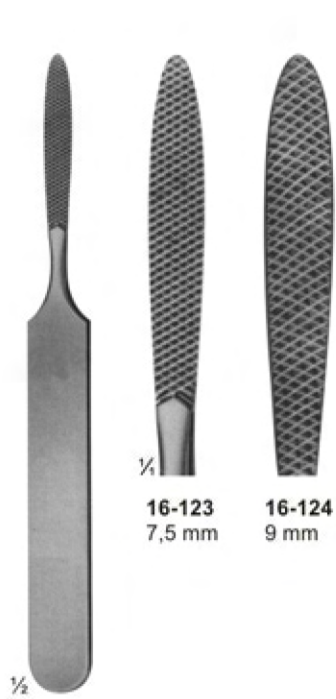

**16-123**  
7,5 mm

**16-124**  
9 mm

**16-123**  
JOSEPH  
fine, chequered

**16-124**  
coarse, chequered  
165 mm

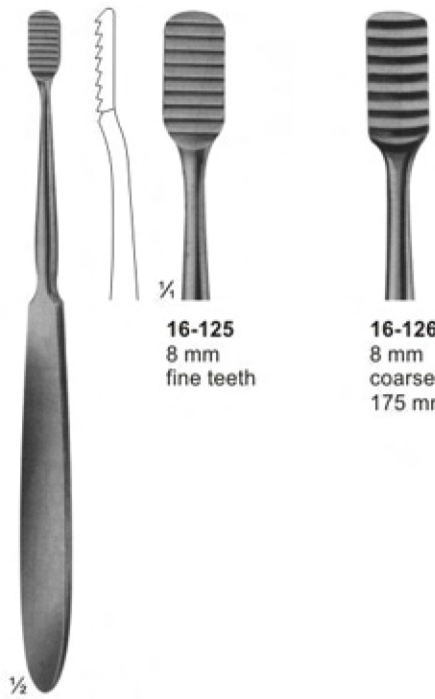

**16-125**  
8 mm  
fine teeth

**16-126**  
8 mm  
coarse teeth  
175 mm

**16-125 - 16-126**  
LEWIS



**16-128**  
9 mm

**16-127**  
MALTZ  
down stroke  
180 mm

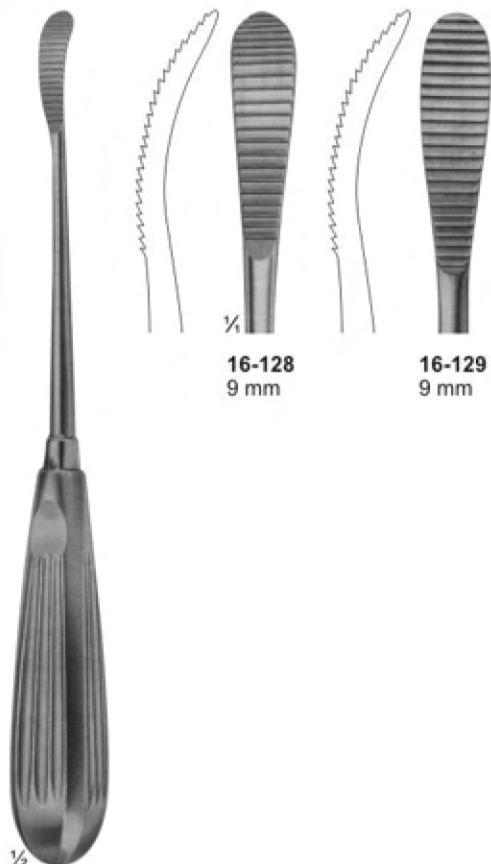

**16-128**  
9 mm

**16-129**  
9 mm

**16-128 - 16-129**  
AUFRICHT  
up stroke  
**16-129**  
down stroke  
220 mm



**16-129**  
9 mm

**16-130**  
GALLAHER  
190 mm

# Bone Curettes

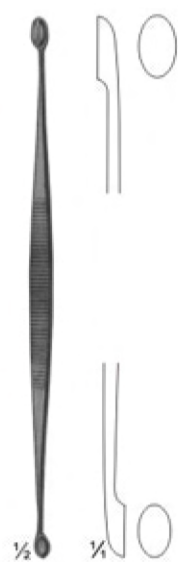

**16-131**  
JACOBSON  
140 mm

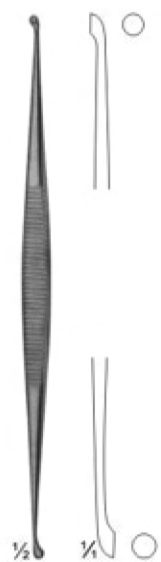

**16-132**  
MARTINI  
140 mm

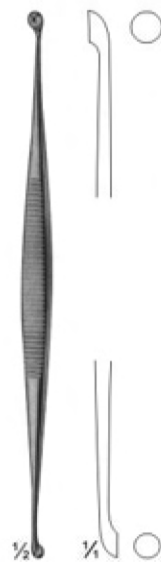

**16-133**  
MARTINI  
140 mm



**16-134**  
WILLIGER  
145 mm



**16-135**  
JANSEN  
160 mm



**16-136**  
BARTH  
180 mm

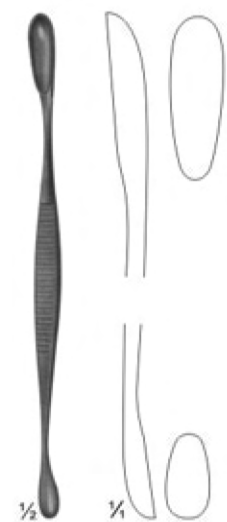

**16-137**  
VOLKMANN  
130 mm

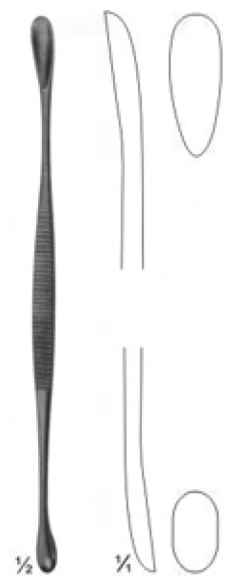

**16-138**  
VOLKMANN  
145 mm

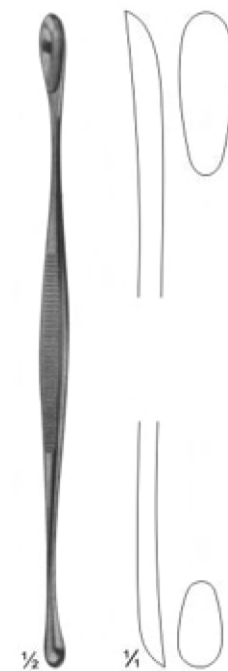

**16-139**  
VOLKMANN  
170 mm



**Mallets** Weights refer to the heads of the mallets  
**Hammer** Die Gewichtsangaben beziehen sich auf den Kopf des jeweiligen Hammers



∅ 20 mm

½

**17-101**  
**MEAD**  
 185 g  
 with interchangeable  
 plastic disks  
 190 mm  
**17-102**  
 pair of spare disks



∅ 25 mm

½

**17-103**  
 140 g  
 with interchangeable  
 plastic disks  
 185 mm  
**17-104**  
 pair of spare disks



∅ 30 mm

½

**17-105**  
**COTTLE**  
 140 g  
 1 Side Flat  
 1 Side convex  
 185 mm



∅ 22 mm

½

**17-106**  
 165 g  
 lead filled head  
 190 mm

# Osteotomes, Chisels and Gouges

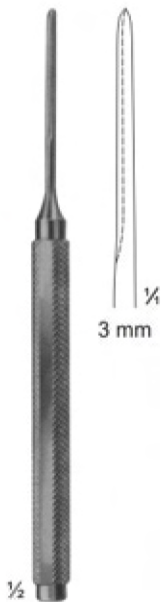

**17-107**  
MANNERFELT  
Gouge  
155 mm

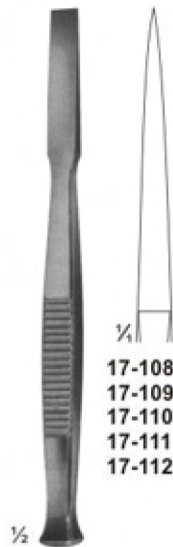

**17-108 - 112**  
Osteotomes  
140 mm

- 17-108 4 mm
- 17-109 6 mm
- 17-110 8 mm
- 17-111 10 mm
- 17-112 12 mm

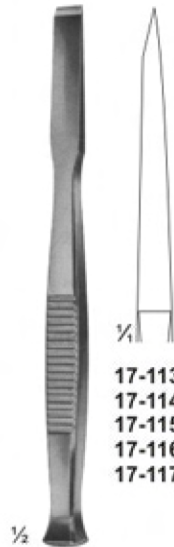

**17-113 - 117**  
Chisels  
140 mm

- 17-113 4 mm
- 17-114 6 mm
- 17-115 8 mm
- 17-116 10 mm
- 17-117 12 mm

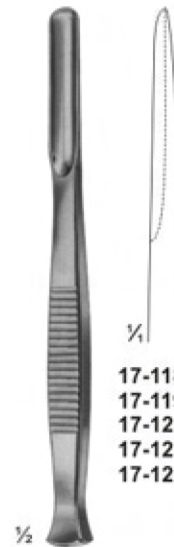

**17-118 - 122**  
Gouges  
140 mm

- 17-118 4 mm
- 17-119 6 mm
- 17-120 8 mm
- 17-121 10 mm
- 17-122 12 mm



**PARTSCH**  
**17-123 - 126**  
Chisels  
140 mm

- 17-123 3 mm
- 17-124 4 mm
- 17-125 5 mm
- 17-126 6 mm

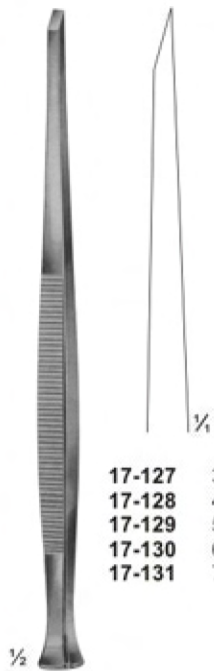

**PARTSCH**  
**17-127 - 131**  
Chisels  
170 mm

- 17-127 3 mm
- 17-128 4 mm
- 17-129 5 mm
- 17-130 6 mm
- 17-131 7 mm

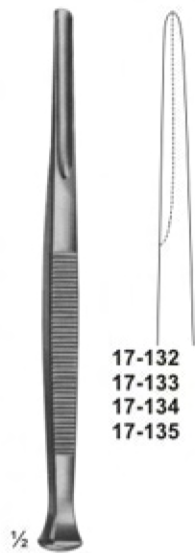

**PARTSCH**  
**17-132 - 135**  
Gouges  
140 mm

- 17-132 3 mm
- 17-133 4 mm
- 17-134 5 mm
- 17-135 6 mm

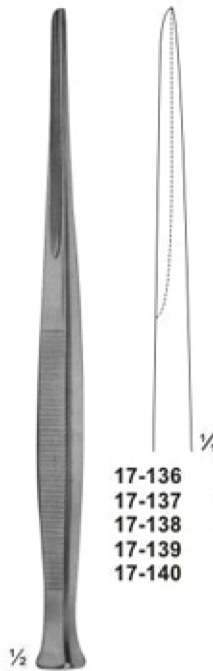

**PARTSCH**  
**17-136 - 140**  
Gouges  
170 mm

- 17-136 3 mm
- 17-137 4 mm
- 17-138 5 mm
- 17-139 6 mm
- 17-140 7 mm



**LUCAS**  
**17-141 - 142**  
Chisels  
160 mm

- 17-141 4 mm
- 17-142 6 mm

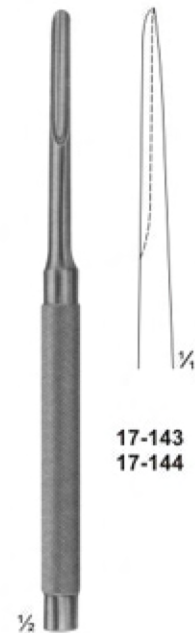

**LUCAS**  
**17-143 - 144**  
Gouges  
160 mm

- 17-143 3 mm
- 17-144 5 mm

## Reposition Forceps, Bone Holding Forceps



**17-145**  
Patella forceps  
185 mm



**17-146**  
Forceps with  
ratchet fixation  
140 mm



**17-147**  
Forceps with  
thread fixation  
170 mm



**17-148**  
Forceps with  
thread fixation  
235 mm

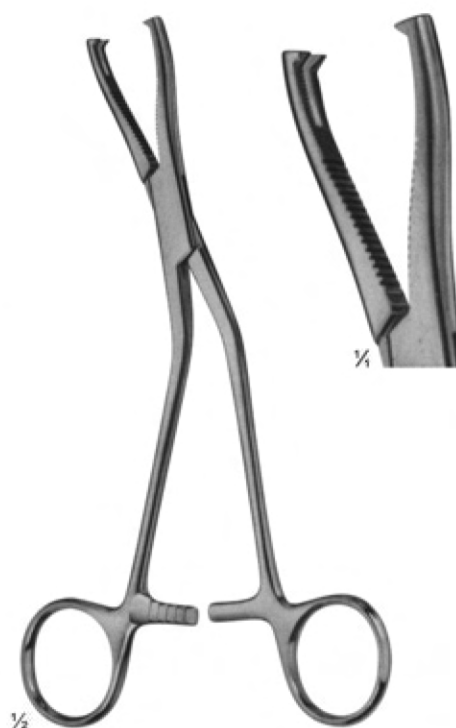

**17-149**  
DINGMANN  
185 mm

# Bone Holding Forceps & Bone Clamps

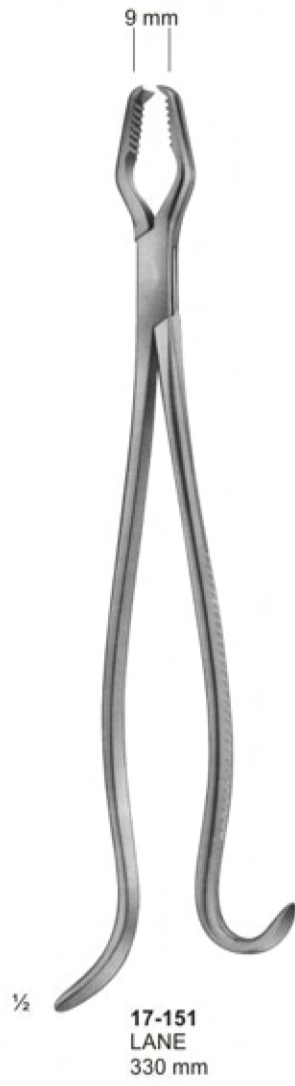



# Bone Rongeurs



**17-158**  
LUER  
150 mm



**17-159**  
LUER  
155 mm



**17-160**  
BLUMENTHAL  
155 mm



**17-161**  
BLUMENTHAL  
150 mm



**17-162 - 163**  
JANSEN  
175 mm

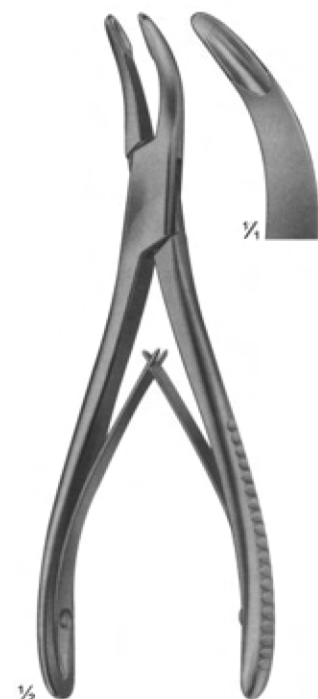

**17-164**  
BANE-HARTMANN  
175 mm

## Bone Rongeurs



**17-165**  
STILLE  
235 mm



**17-166**  
LEKSELL-STILLE  
240mm



**17-167**  
STILLE-RUSKIN  
240mm

# Bone Cutting Forceps



**17-168**  
LISTON  
curved on flat  
240 mm

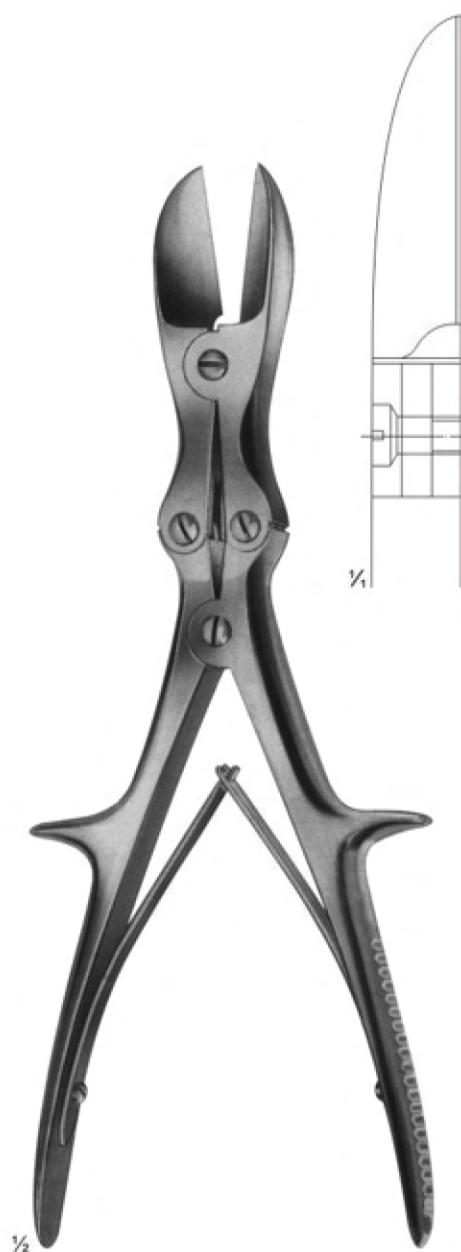

**17-169**  
LISTON  
straight  
280 mm

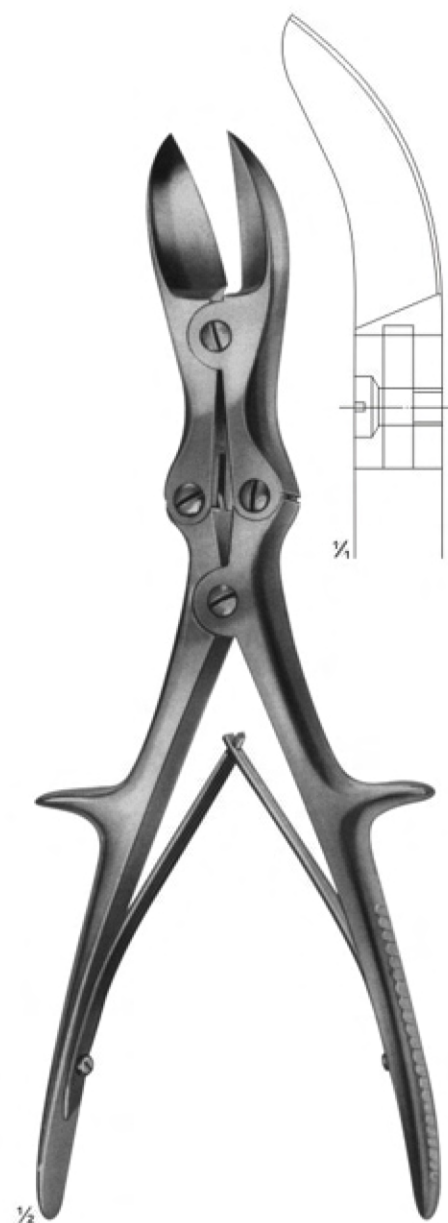

**17-170**  
LISTON  
curved on flat  
280 mm

# Wire Extension

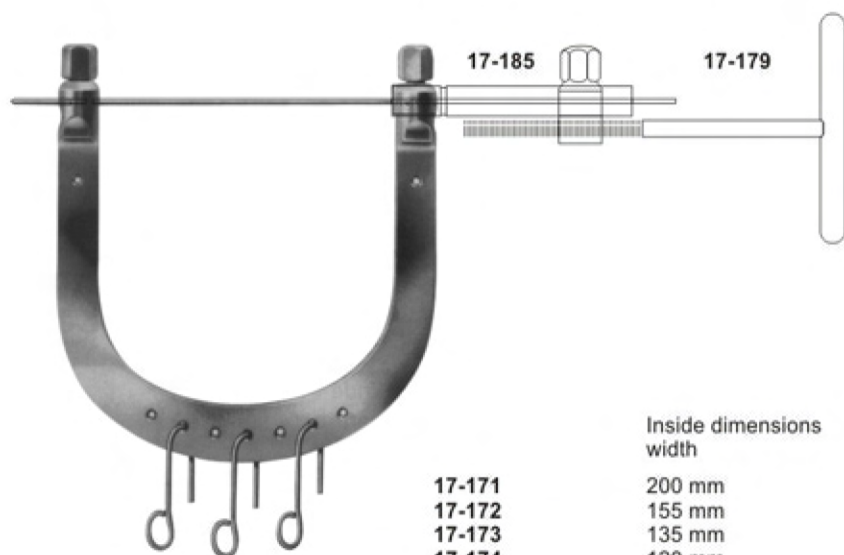

**17-171 - 17-177**  
KIRSCHNER  
Wire traction bows,  
to be used with  
KIRSCHNER-wires  
up to 2.5 mm diam.,  
With 3 hooks,  
stainless steel

	Inside dimensions width	depth	
17-171	200 mm	155 mm	for the hip
17-172	155 mm	155 mm	for the femur
17-173	135 mm	130 mm	for the knee
17-174	120 mm	120 mm	for the knee
17-175	105 mm	100 mm	for the knee
17-176	95 mm	110 mm	for the calcaneus
17-177	95 mm	70 mm	for the arm and elbow



**17-178**  
Wrench, double - ended,  
for wire traction bows

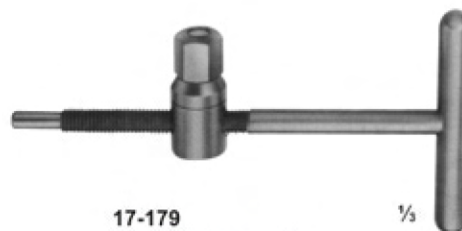

**17-179**  
Wire tightener, with  
clamping jaws



17-182	max. 105 mm
17-183	max. 160 mm
17-184	max. 200 mm
17-182	80-95 mm
17-183	90-120 mm
17-184	140-170 mm
diam upto	
17-182	1,6 mm
17-183	2,0 mm
17-184	2,5 mm

**17-182 - 17-184**  
KIRSCHNER  
Wire traction bows, modified,  
adjustable in width, holds wire  
securely, with 1 hook



**17-180**  
Traction hook only,  
large size



**17-181**  
Traction hook only,  
small size



**17-185**  
Fixation clamp, to secure clamping  
jaws of 17-179 stainless steel



# Cerclage Instruments

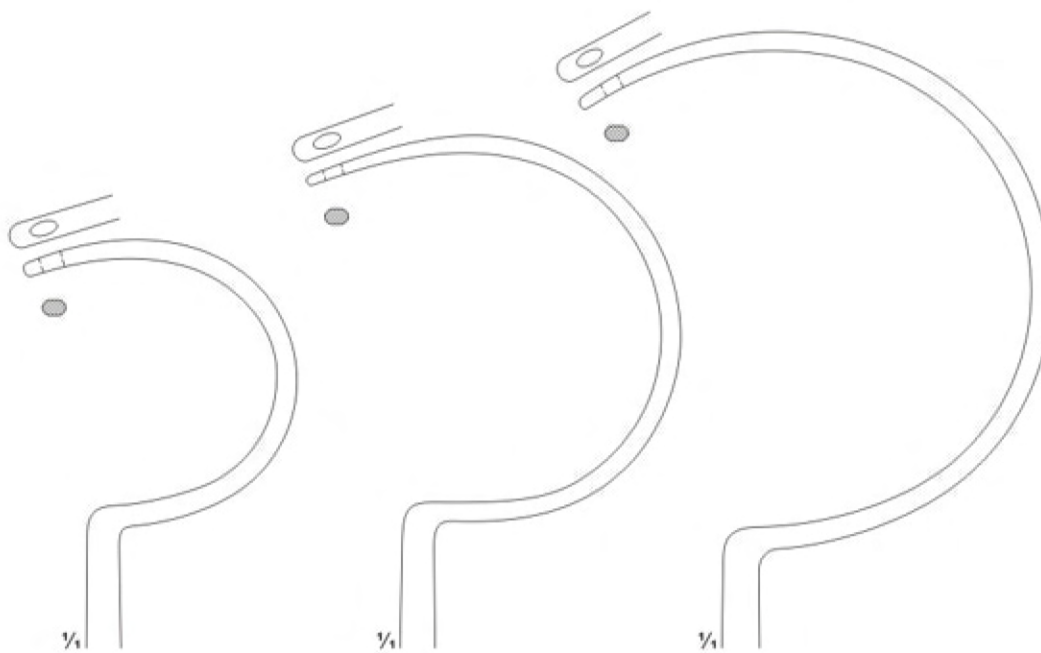

**17-186**  
275 mm

**17-187**  
285 mm

**17-188**  
305 mm



**17-186 - 17-188**  
DEMEL  
Wire guides

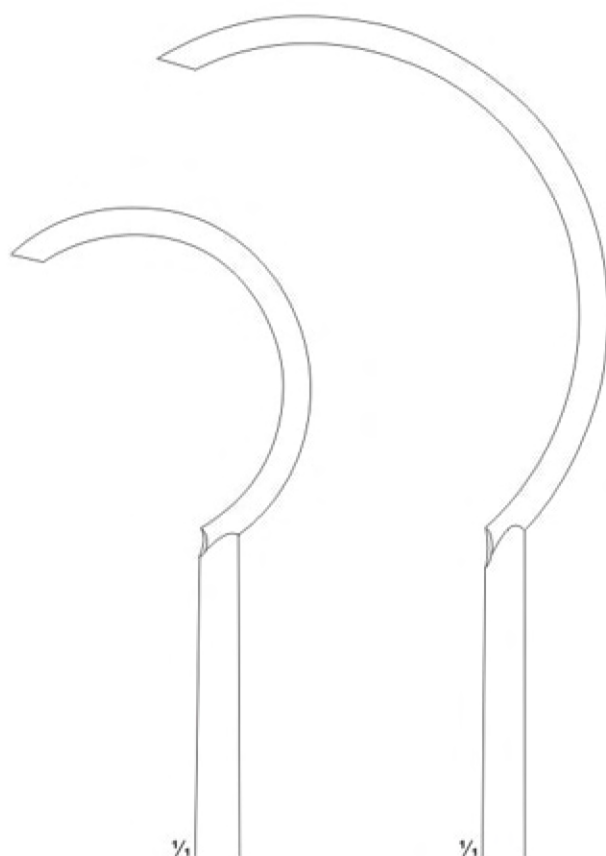

**17-189**  
240 mm

**17-190**  
270 mm

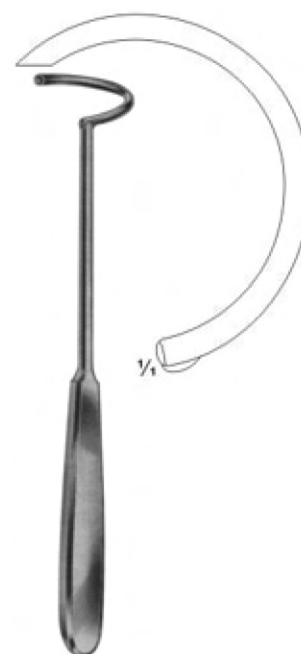

**17-191**  
225 mm

# Wire Holding forceps, Wire Tightening Pliers, Flat-nosed Pliers DUROGRIP with Hard Metal Inserts



**17-192**  
DUROGRIP  
Holding forceps for cerclage wire, with lateral jaws to avoid wire slipping off  
170 mm



**17-193**  
DUROGRIP  
Wire, tightening pliers, Ligature pliers  
150 mm



**17-194**  
DUROGRIP  
Wire, tightening pliers, Ligature pliers  
150 mm



**17-195**  
with serrated jaws  
140 mm



**17-196**  
one jaw smooth, one jaw serrated  
140 mm



**17-197**  
with serrated jaws  
**17-198**  
with longitudinal and transversal grooves  
170 mm



**17-199**  
190 mm

# Wire Holding forceps, Flat-nosed Pliers, Pliers for bending and cutting wires

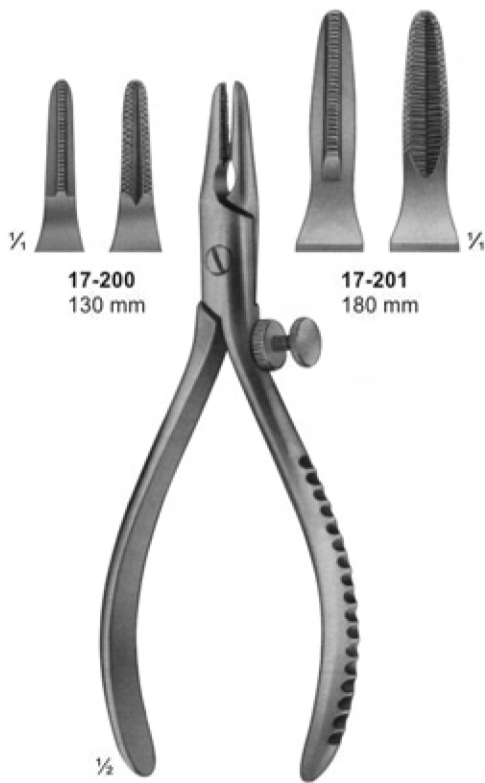

**17-200**  
130 mm

**17-201**  
180 mm

**17-200 - 17-201**  
Extraction pliers  
for boring wires



**17-202**  
Flat-nosed pliers,  
parallel  
185 mm

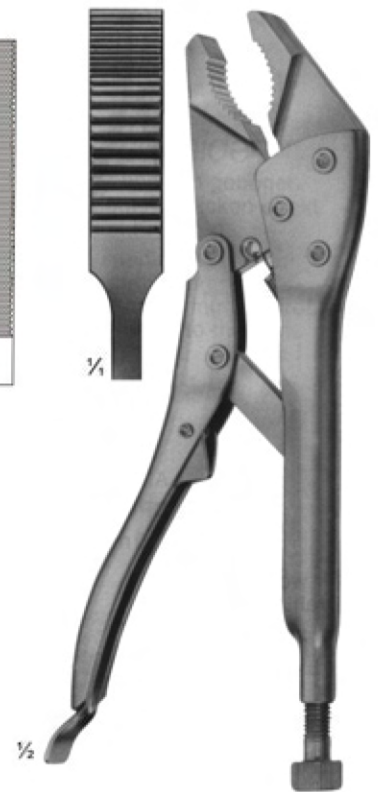

**17-203**  
Vise grip  
200 mm

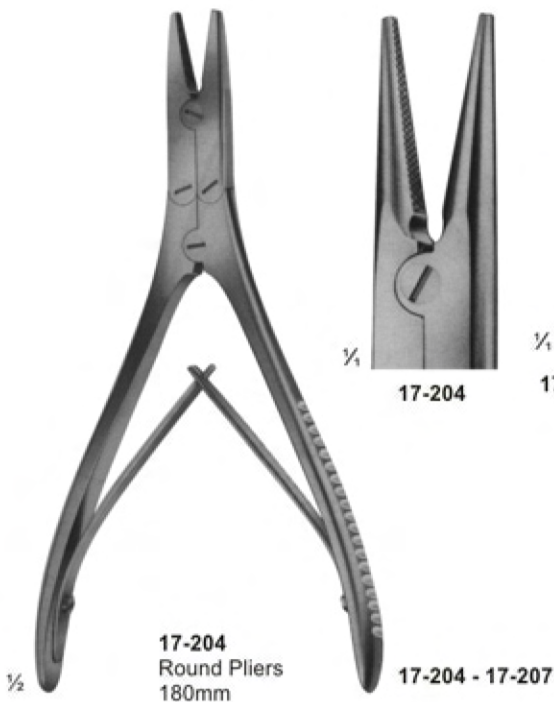

**17-204**  
Round Pliers  
180mm

**17-204 - 17-207**

**17-205** 145 mm  
**17-206** 180 mm  
**17-207** 180 mm  
Extraction pliers for wires



**17-208**  
Bending pliers  
for wires up to  
1.8 mm diam.

# Wire Cutters and wire Cutting Scissors DUROTIP with Carbide Cutting Edges



**17-209**  
ANGLE  
130 mm

for soft wire  
up to diam. 0,5 mm  
for hard wire  
up to diam. 0,3 mm

**17-210**  
DUROTIP  
ANGLE  
130 mm

0,6 mm  
0,4 mm

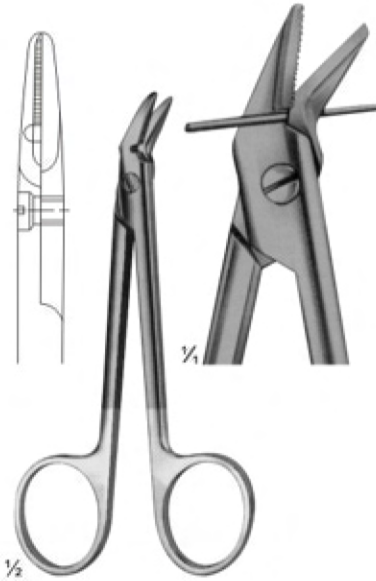

**17-211**  
120 mm

for soft wire  
up to diam. 1,2 mm  
for hard wire  
up to diam. 0,8 mm

**17-212**  
DUROTIP  
120 mm

1,2 mm  
0,8 mm

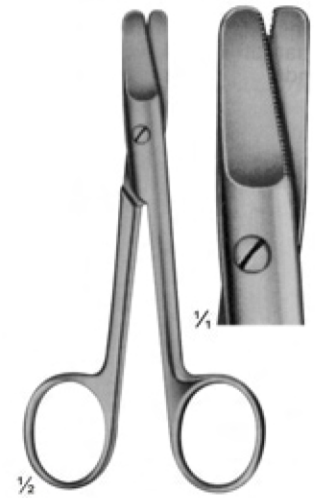

**17-213**  
HARVEY  
125 mm

0,4 mm  
0,3 mm

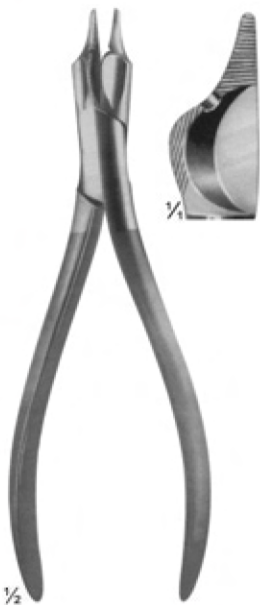

**17-214**  
150 mm

for soft wire  
up to diam. 1,5 mm  
for hard wire  
up to diam. 1,0 mm



**17-215**  
160 mm

1,5 mm  
1,2 mm



**17-216**  
140 mm  
DUROTIP  
1,5 mm

1,0 mm



## Wire Cutting Pliers, Lateral Cutting Action

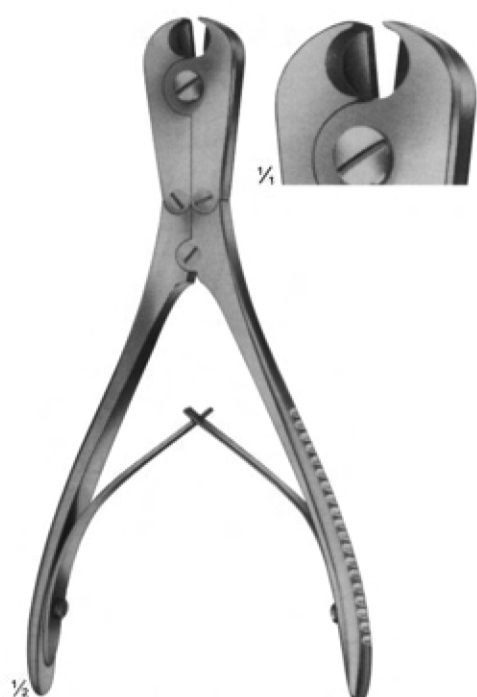

**17-217**  
180 mm

for soft wire  
up to diam. 2,0 mm  
For hard wire 1,5 mm  
up to diam  
specially hardened  
cutting edges, front  
and lateral cutting  
action



**17-218**  
REILL  
175 mm

for soft wire  
up to diam. 2,0 mm  
For hard wire 1,6 mm  
up to diam  
specially hardened  
cutting edges, for  
cutting off wires close  
to the bone



**DUROTIP**

**17-219**  
235 mm

for soft wire  
up to diam. 3,0 mm  
For hard wire 2,2 mm  
up to diam

# Wire Cutting Pliers, Lateral and Front Cutting Action



**17-220**  
240 mm

for soft wire up to diam. 2,0 mm  
For hard wire up to diam 1,6 mm



**17-221**  
145 mm

for soft wire up to diam. 1,5 mm  
For hard wire up to diam 1,0 mm



**17-222**  
145 mm

for soft wire up to diam. 2,0 mm  
For hard wire up to diam 1,5 mm



**17-223**  
220 mm

for soft wire up to diam. 3,5 mm  
For hard wire up to diam 2,5 mm

# Wire Cutting Pliers



**17-224**  
320 mm

for soft wire  
up to diam. 3,0 mm  
For hard wire  
up to diam. 3,0 mm

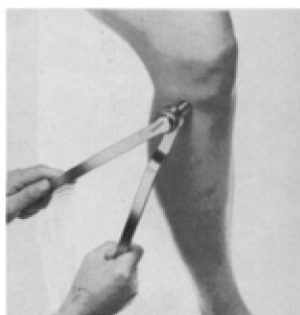

Cutter for cutting off  
KIRSCHNER wires,  
Tibia head screws,  
bolts, pins, up to 3 mm diam.



**DUROTIP**

**17-225**  
Cutter for cutting off  
KIRSCHNER wires,  
Tibia head screws,  
bolts, pins, up to 6 mm diam.  
470 mm

## Finger Nail Instruments

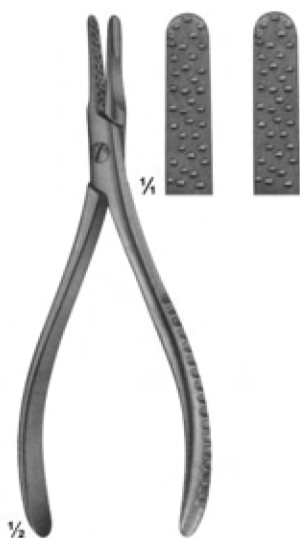

**17-226**  
Nail extracting  
forceps  
135 mm



**17-227**  
Nail extracting  
forceps  
145 mm

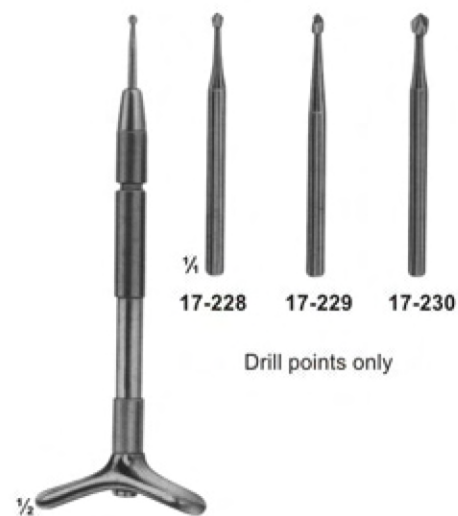

**17-228**  
Finger nail drill  
with 3 drill points

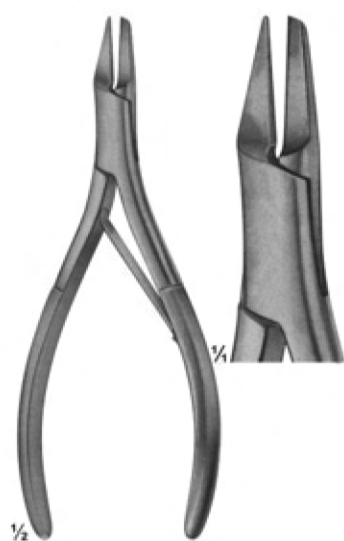

**17-231**  
Nail splitting  
forceps  
135 mm

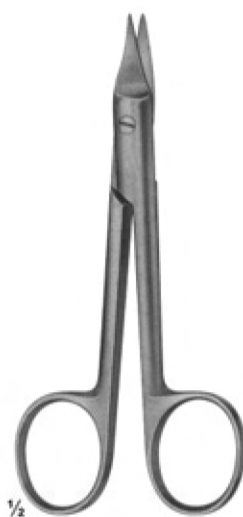

**17-232**  
SYSTRUNK  
Scissors, for splitting  
finger nails  
130 mm



**17-233**  
Finger ring saw  
150 mm



# Plaster Shears



**17-235**  
STILLE-AESULAP  
260 mm



**17-236**  
STILLE-AESULAP  
360 mm

# Plaster Spreader, Plaster Breakers



**17-237**  
HENING  
270 mm



**17-238**  
MOD.USA  
230 mm



**17-239**  
290 mm



with removable jaws



**17-240 - 17-241**  
WOLFF  
**17-240** 180 mm  
**17-241** 240 mm  
plaster breakers

# Vacuum Curettes for Aspiration Lipectomy, Suction Instruments

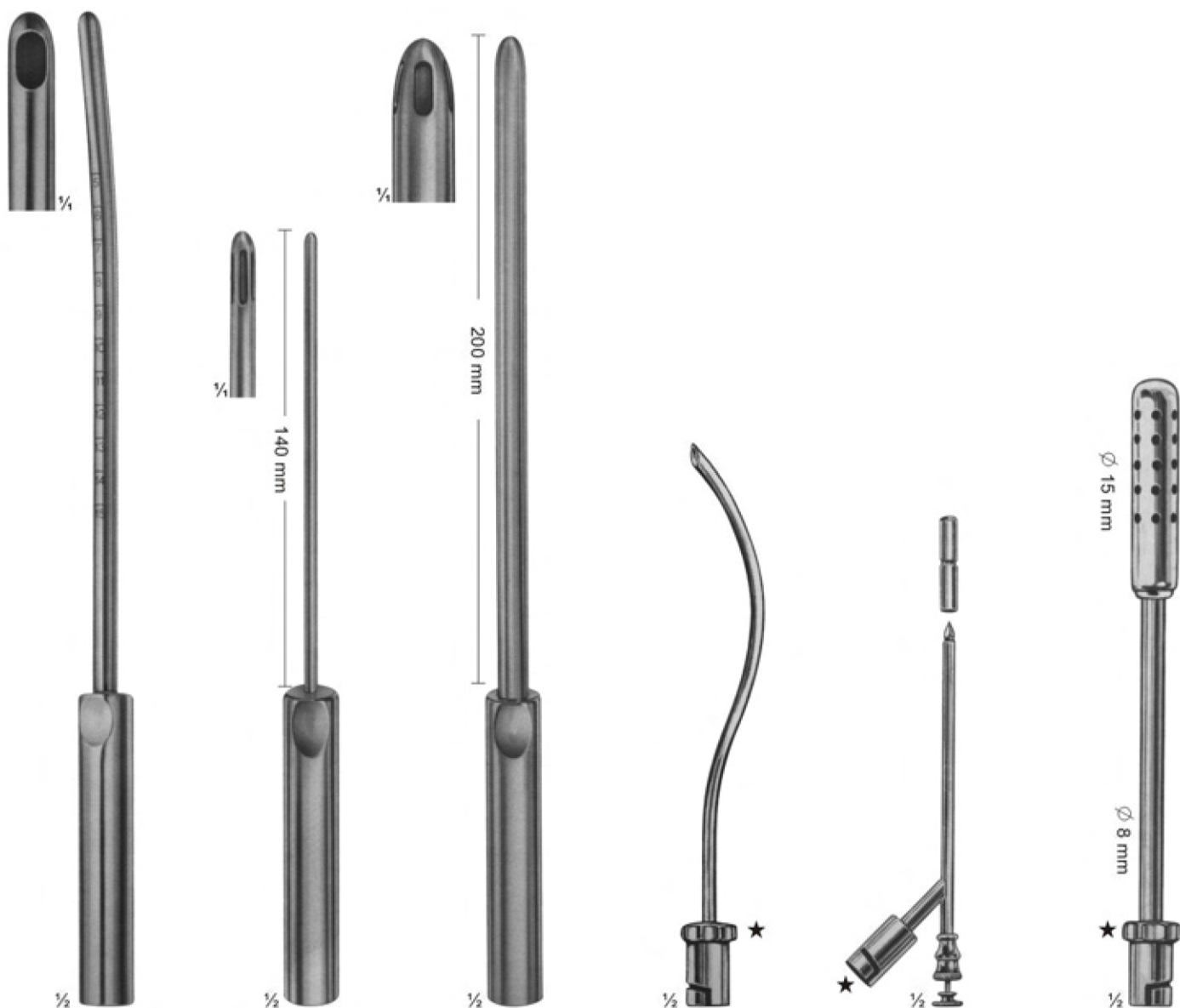

**18-101 - 18-106**  
BIEMER

18-101  $\varnothing$  4 mm  
18-102  $\varnothing$  6 mm  
18-103  $\varnothing$  8 mm  
18-104  $\varnothing$  10 mm  
18-105  $\varnothing$  12 mm  
18-106  $\varnothing$  14 mm

Curettes for aspiration lipectomy, graduated, slightly curved

**18-107 - 18-108**  
BIEMER

18-107  $\varnothing$  4 mm  
18-108  $\varnothing$  6 mm

Curettes for aspiration lipectomy, with three apertures, slightly curved malleable

**18-109 - 18-111**  
BIEMER

18-109  $\varnothing$  8 mm  
18-110  $\varnothing$  10 mm  
18-111  $\varnothing$  12 mm

Curettes for aspiration lipectomy, with three apertures, slightly curved malleable

**18-112**  
For aspirating fluid from the excretory ducts of large glands and for keeping the operating area clear 170 mm

**18-113**  
Trocar  
For puncturing 150 mm

**18-114**  
For clearing large quantities of fluid 190 mm

# Suction Instruments

**18-115** 150mm  
Suction handle, with vacuum regulator and finger cut-off, brass, mirror-finish chromium-plated

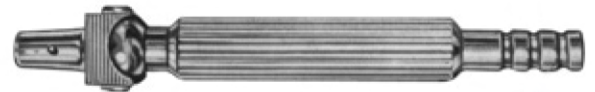

olive  
Ø9 mm

**18-116** 170mm  
Suction handle, with hand regulation valve and quick-shutter, brass, mirror-finish chromium-plated



★ Both suction handles have bayonet fitting olive and can be used for the suction cannulae. Ø9 mm

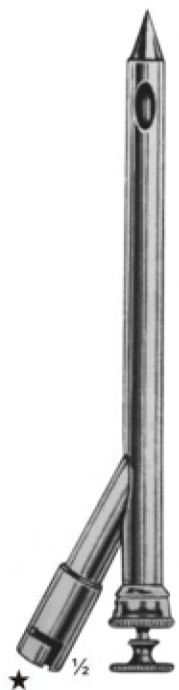

**18-117**  
Trocar  
For puncturing  
170 mm



**18-118**  
Hollow needle,  
sharp  
150 mm



**18-119**  
double curved  
For general  
surgery  
230 mm



**18-120**  
For tonsillectomy,  
oral and laryngeal  
operations  
190 mm



**18-121**  
For tonsillectomy,  
oral and laryngeal  
operations  
220 mm

★ With bayonet fitting to be used with suction handles (18-115 - 18-116)



# Suction Instruments

**18-122**  
WULLSTEIN  
Suction tube, conical, silver, olive  
with LUER hub  
160 mm



**18-123** 1,5 mm  
**18-124** 2,0 mm  
WULLSTEIN  
Suction tube, cylindrical, silver, with  
stylet olive with LUER hub  
160 mm



Usable length

YASARGIL usable length diam.		YASARGIL usable length diam.	
<b>18-125</b>	130 mm 1,5 mm	<b>18-133</b>	130 mm 2,5 mm
<b>18-126</b>	150 mm 1,5 mm	<b>18-134</b>	150 mm 2,5 mm
<b>18-127</b>	180 mm 1,5 mm	<b>18-135</b>	180 mm 2,5 mm
<b>18-128</b>	220 mm 1,5 mm	<b>18-136</b>	220 mm 2,5 mm
<b>18-129</b>	130 mm 2,0 mm	<b>18-137</b>	130 mm 3,5 mm
<b>18-130</b>	150 mm 2,0 mm	<b>18-138</b>	150 mm 3,5 mm
<b>18-131</b>	180 mm 2,0 mm	<b>18-139</b>	180 mm 3,5 mm
<b>18-132</b>	220 mm 2,0 mm	<b>18-140</b>	220 mm 3,5 mm
		<b>18-141</b>	180 mm 4,5 mm

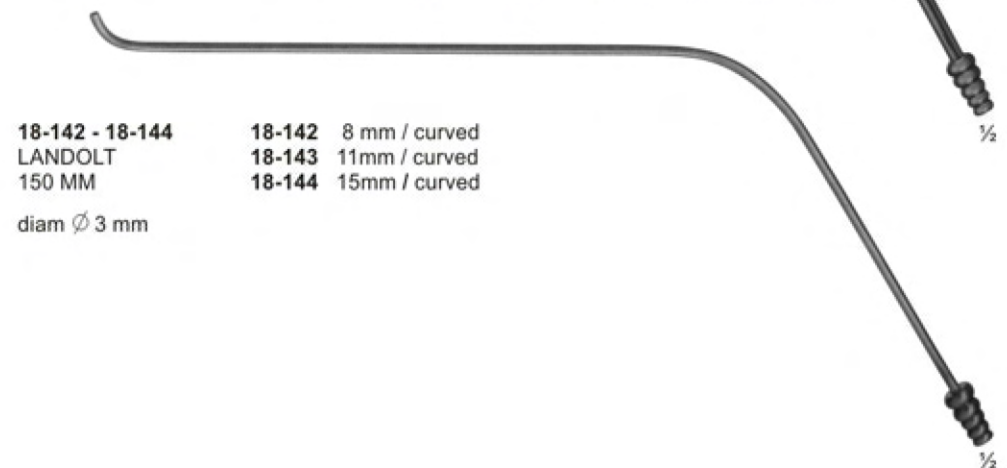

**18-142 - 18-144**  
LANDOLT  
150 MM  
diam  $\phi$  3 mm

**18-142** 8 mm / curved  
**18-143** 11mm / curved  
**18-144** 15mm / curved

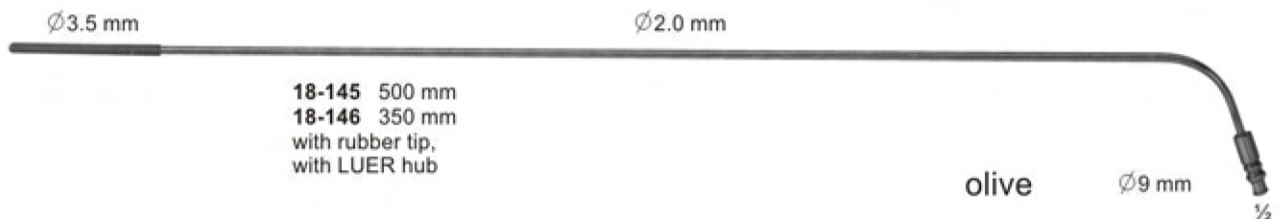

**18-145** 500 mm  
**18-146** 350 mm  
with rubber tip,  
with LUER hub

**18-147** 2,0 mm diam  
**18-148** 2,5 mm diam  
**18-149** 3,0 mm diam  
with finger cut-off,  
thumb piece 90° to  
curve, with LUER hub  
250 mm



# Combined Suction and Irrigation Cannulae, Coagulation Suction Cannulae

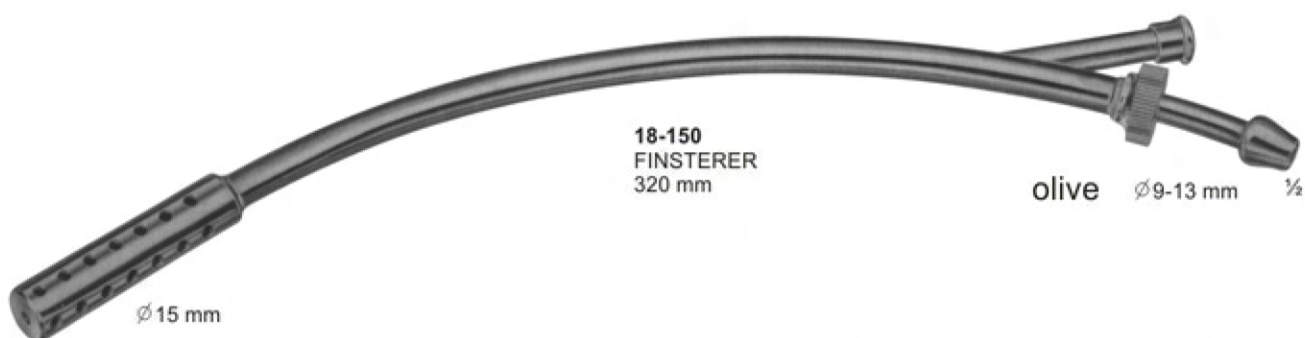

**18-151**  
YASARGIL  
LUER-LOCK cone  
200 mm

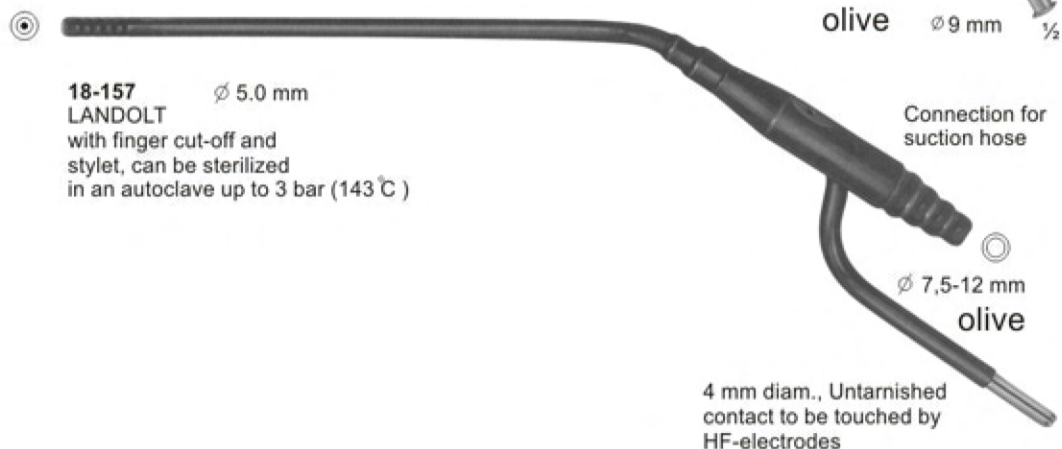
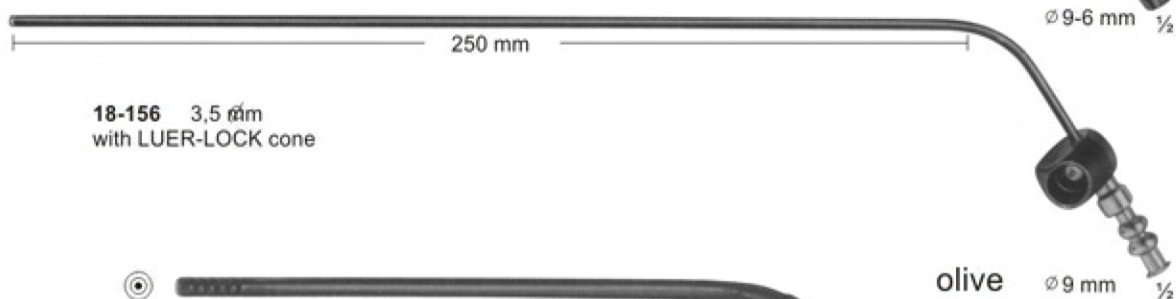
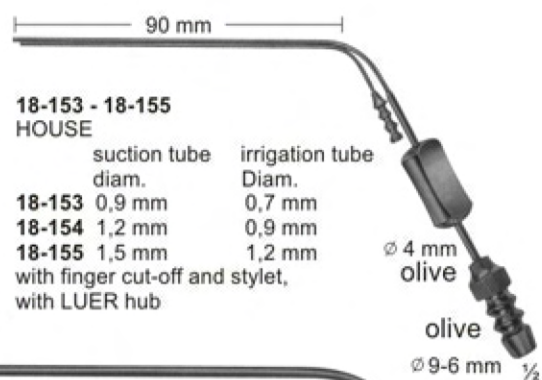
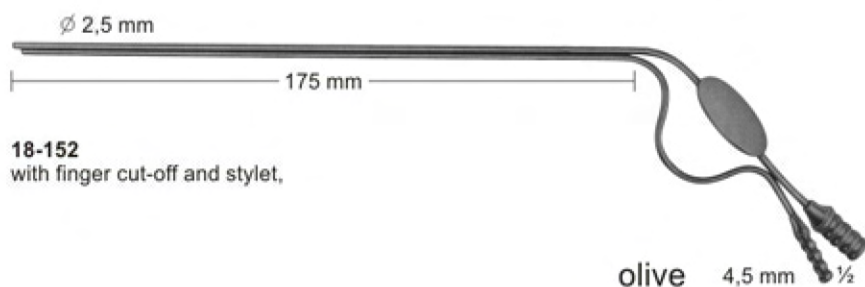

# Suction Instruments

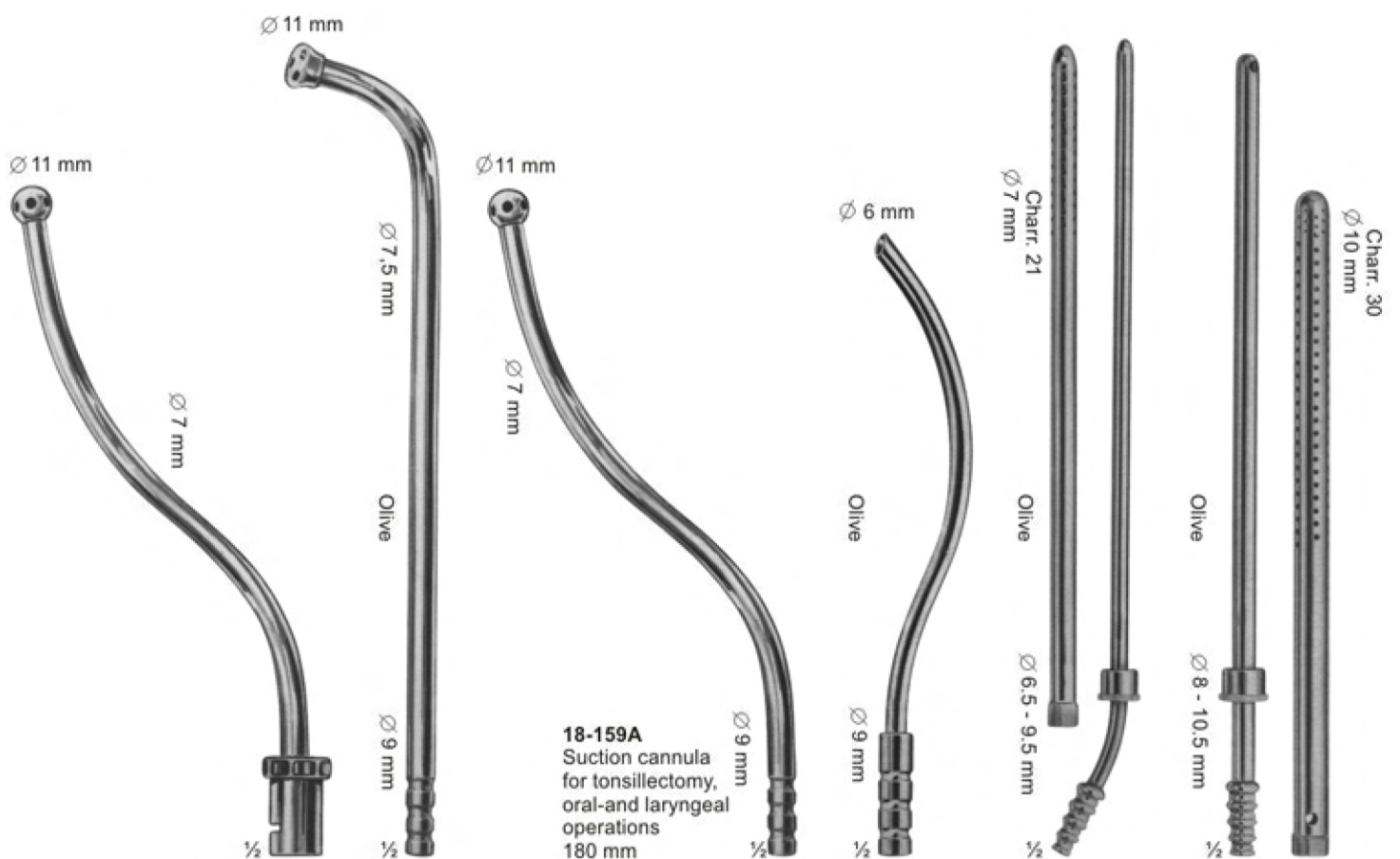

**18-158**  
For tonsillectomy,  
oral-and laryngeal  
operations  
180 mm

**18-159**  
Suction cannula  
for tonsillectomy,  
oral-and laryngeal  
operations  
220 mm

**18-159A**  
Suction cannula  
for tonsillectomy,  
oral-and laryngeal  
operations  
180 mm

**18-160**  
S-shaped blunt cannula  
for aspirating fluid from  
the excretory ducts of  
large glands and for  
keeping the operating  
area clear  
170 mm

**18-161**  
POOL  
Suction cannula,  
with outer tube  
to be screwed of  
225 mm

**18-162**  
POOL  
Suction cannula,  
with outer tube  
to be screwed off  
225 mm

# Suction Instruments

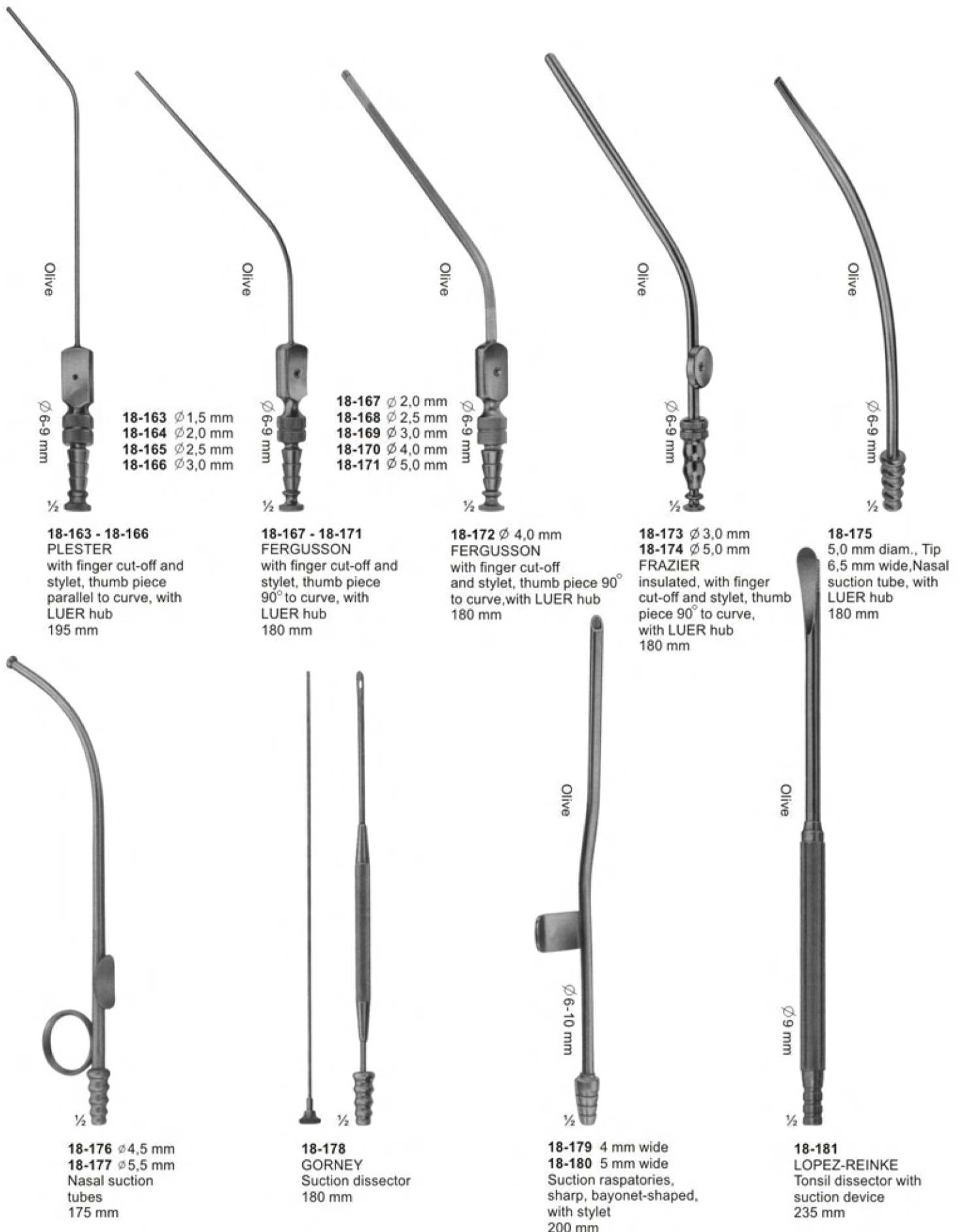

**18-163 - 18-166**  
**PLESTER**  
 with finger cut-off and stylet, thumb piece parallel to curve, with LUER hub  
 195 mm

**18-163**  $\varnothing$  1,5 mm  
**18-164**  $\varnothing$  2,0 mm  
**18-165**  $\varnothing$  2,5 mm  
**18-166**  $\varnothing$  3,0 mm

**18-167 - 18-171**  
**FERGUSSON**  
 with finger cut-off and stylet, thumb piece 90° to curve, with LUER hub  
 180 mm

**18-167**  $\varnothing$  2,0 mm  
**18-168**  $\varnothing$  2,5 mm  
**18-169**  $\varnothing$  3,0 mm  
**18-170**  $\varnothing$  4,0 mm  
**18-171**  $\varnothing$  5,0 mm

**18-172**  $\varnothing$  4,0 mm  
**FERGUSSON**  
 with finger cut-off and stylet, thumb piece 90° to curve, with LUER hub  
 180 mm

**18-173**  $\varnothing$  3,0 mm  
**18-174**  $\varnothing$  5,0 mm  
**FRAZIER**  
 insulated, with finger cut-off and stylet, thumb piece 90° to curve, with LUER hub  
 180 mm

**18-175**  
 5,0 mm diam., Tip 6,5 mm wide, Nasal suction tube, with LUER hub  
 180 mm

**18-176**  $\varnothing$  4,5 mm  
**18-177**  $\varnothing$  5,5 mm  
 Nasal suction tubes  
 175 mm

**18-178**  
**GORNEY**  
 Suction dissector  
 180 mm

**18-179** 4 mm wide  
**18-180** 5 mm wide  
 Suction raspatories, sharp, bayonet-shaped, with stylet  
 200 mm

**18-181**  
**LOPEZ-REINKE**  
 Tonsil dissector with suction device  
 235 mm



## Dissection Instruments

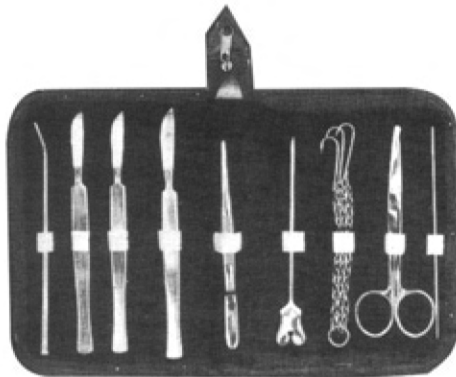

### 18-182

- 1- Blow pipe .
- 2- 3 PCS .scalpel.
- 3- Dissecting forcecp 13 cm.
- 4- Grooved director with tounge tie 13 cm.
- 5- Triple chain hook.
- 6- Dressing scissors probe pointed 13 cm.
- 7- Probe double 13 cm.
- 8- Zipper case inside red velvet.

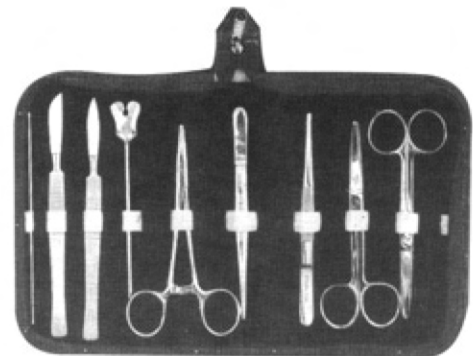

### 18-183

- 1- Probe Double 13 cm
- 2- 2 PCS. Scalpel S.S
- 3- Grooved Director With tongue Tie 13 cm
- 4- Mayo Hegar Needle Holder 13cm
- 5- Discting Forcep 13 cm 1x2 Teeth
- 6- Dressing Forcecp 13 CMS Serrated.
- 7- Dressing Scissor 13 cm S/B STR.
- 8- Dressing Scissor 13 cm S/B CVD.
- 9- Zipper Case Inside Red Velvet.

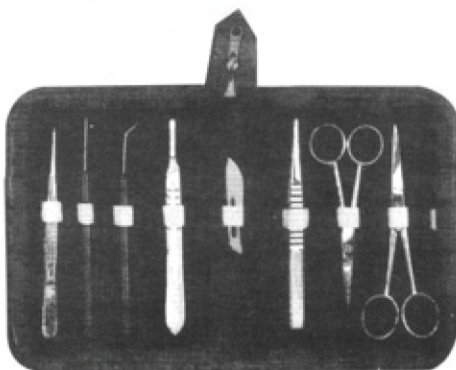

### 18-184

- 1- Dissecting Forcecp 11.5 cm Sharp Point.
- 2- Iris Scissor
- 3- B.P Handle No. 4
- 4- Teasing Needle Sharp angular.
- 5- Blade No. 22
- 6- Thumb Forceps T.O.E 13 cm
- 7- Dissecting Scissor STR 11.5 cm
- 8- Dissecting Scissor STR 13 cm
- 9- Zipper case Inside Red Velvet

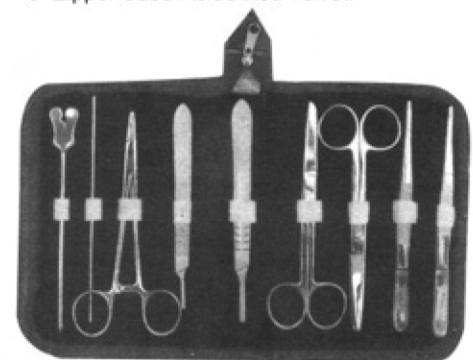

### 18-185

- 1- Grooved Director with Tongue Tie 14 cm
- 2- Probe Double 14cm
- 3- Mayo Hegar Needle Holder 14 cm
- 4- BP. Handle no.3
- 5- BP. Handle no.4
- 6- Dressing Scissor 14 cm S/B STR
- 7- Dressing Scissor 14 cm S/B CVD.
- 8- Dressing Forcecp 1x2 Teeth 14 cm
- 9- Dressing Forcecp Serrated 14 cm

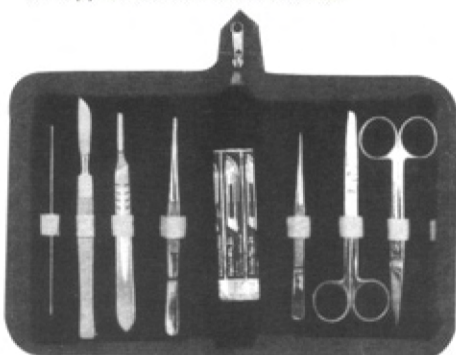

### 18-186

- 1- Probe double 12.5 cm
- 2- Scalpel
- 3- B.P Handle No. 4
- 4- 6 PCS Blade 2 each no. 21, 22, 23
- 5- Dissecting Forcecp 12.5 cm
- 6- Dissecting Forcecp 11.5 cm sharp Point
- 7- Dissecting Scissor S/B STR 13 cm
- 8- Dissecting Scissor S/S STR 13 cm

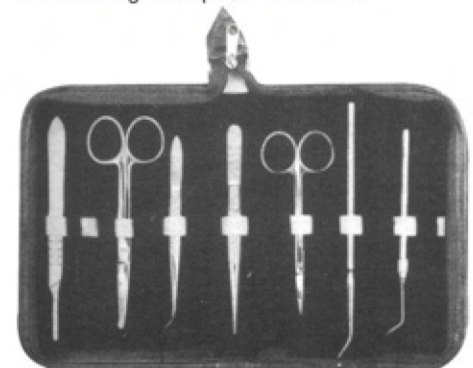

### 18-187

- 1- Teasing Needle with Chuck CVD.
- 2- Huber Probe
- 3- Iris Scissor
- 4- Dissecting Forcecp Fine 14 cm.
- 5- Dissecting Forcecp Fine CVD. 12 cm
- 6- Operating Scissor with Probe 14 cm.
- 7- B.P. Handle no. 4

## Dissection Instruments



### 18-188

- 1- Probe with eye
- 2- Dissecting Forcep cvd fine 12 cm.
- 3- Iris Scissor
- 4- Operating Scissor S/B str 14 cm
- 5- Grooved Director and Tongue tie
- 6- Huber Probe
- 7- Triple Chain Hook
- 8- B.P Handle No. 4
- 9- B.P Handle No. 3
- 10- Teasing Needle with Chuck cvd.
- 11- Teasing Needle with Chuck str.
- 12- Dissecting Forceps Fine 14 cm.

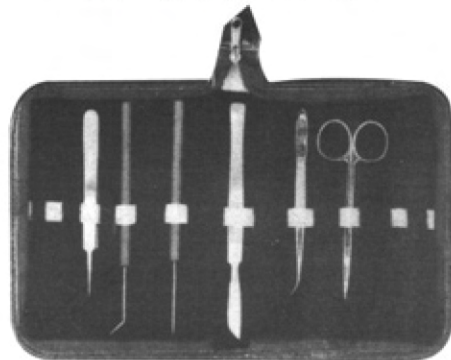

### 18-190

- 1- Iris Scissor STR
- 2- Dissecting Forceps CVD 12 cm.
- 3- Scalpel
- 4- Teasing Needle STR wooden handle.
- 5- Teasing Needle CVD wooden handle.
- 6- Watchmaker fine point.

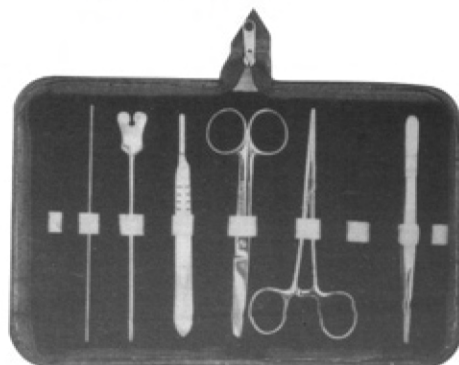

### 18-192

- 1- Probe double end.
- 2- Grooved director and tounge tie.
- 3- B.P handle no.4
- 4- Operating scissor STR S/b14cm.
- 5- Kelly forceps STR 14cm.
- 6- Dissecting forceps thumb 13cm.

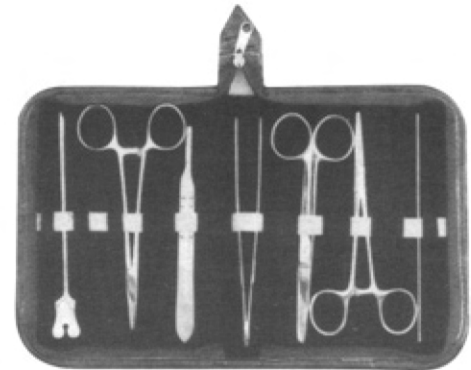

### 18-189

- 1- Grooved Director and Tongue tie
- 2- Mayo Hearg Needle Holder 14 cm
- 3- B.P Handle No. 4
- 4- Dissecting Forceps Thump 14 cm.
- 5- Operating Scissor S/B str 14 cm
- 6- Kelly Forcep STR 14 cm.
- 7- Probe Double end

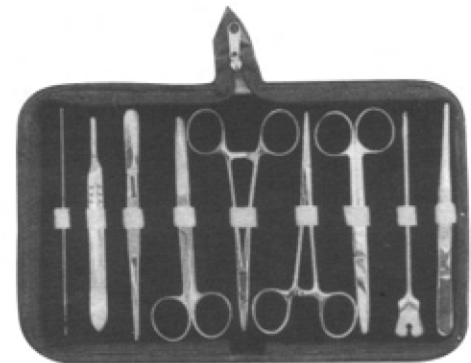

### 18-191

- 1- Probe Double end
- 2- B.P Handle No. 4
- 3- Dissecting Forcep 1x2 Teeth 14 cm.
- 4- Operating Scissor S/B str 14 cm
- 5- Mayo Hearg Needle Holder 14 cm
- 6- Kelly Forcep STR 14 cm.
- 7- Operating Scissor S/B CVD 14 cm
- 8- Grooved Director and Tongue tie
- 9- Dissecting Forceps Thumb 14 cm.

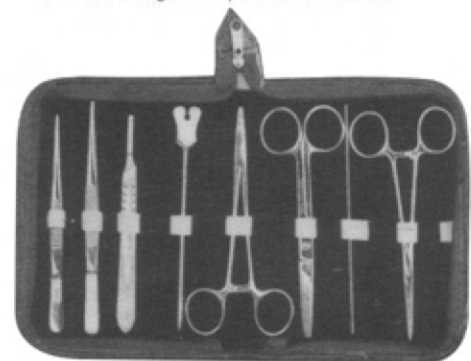

### 18-193

- 1- Dissecting Forceps Thumb 14 cm
- 2- Dissecting Forcep 1x2 Teeth 14 cm.
- 3- B.P Handle No. 3
- 4- Grooved Director and Tongue tie
- 5- Mayo Hearg Needle Holder 14 cm
- 6- Operating Scissor S/B str 14 cm
- 7- Probe Double end
- 8- Kelly Forcep STR 14 cm.



## Dissection Instruments

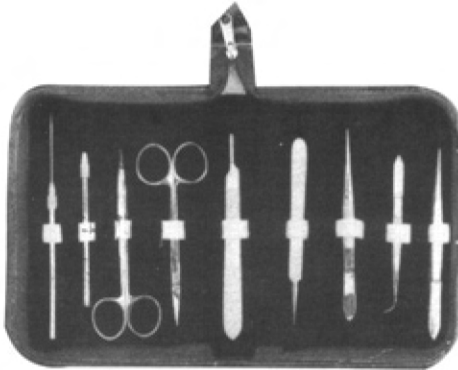

### 18-194

- 1- Dissecting Forcep Fine 14cm.
- 2- Dissecting Forcep Fine CVD 12cm
- 3- Dissecting Forcep with Pin 14cm.
- 4- Watchmaker Fine point
- 5- Iris scissor STR
- 6- Iris scissor CVD.
- 7- Teasing Needle holder
- 8- Teasing Needle STR.
- 9- B.P. Handle no. 3



### 18-195

- 1- Teasing Needle STR.
- 2- Grooved Director and Tongue Tie.
- 3- Teasing Needle CVD.
- 4- Dissecting Forcep with Pin 12 cm Fine
- 5- Operating Scissor S/B STR 14 cm
- 6- Triple Chain Hook
- 7- Probe with eye
- 8- Probe Double end
- 9- Probe and Hook
- 10- Dissecting Forcep Fine 14 cm
- 11- Iris Scissor
- 12- Huber Probe
- 13- B.P. Handle no.3
- 14- B.P. Handle no.4



### 18-196

- 1- Dissecting forcep fine STR with pin 12cm.
- 2- Iris scissor STR.
- 3- Probe with eye.
- 4- Probe and hook.
- 5- Operating scissor S/B STR 14cm
- 6- Triple chain hook.
- 7- B.P. handle no.4
- 8- Humber probe.
- 9- B.P.handle no.3
- 10- Teasing needle STR plastic handle.
- 11- Teasing needle CVD plastic handle.
- 12- Grooved director and tongue tie.
- 13- Probe double end.



### 18-197

- 1- Dissecting Forceps Thumb 14 cm.
- 2- Dissecting Forcep 1x2 Teeth 14 cm.
- 3- B.P Handle No. 3
- 4- Grooved Director and Tongue tie
- 5- Mayo Hearg Needle Holder 14 cm
- 6- Operating Scissor S/B str 14 cm
- 7- Probe Double end
- 7- Kelly Forcep STR 14 cm.

# Hospital Wares



**19-101 - 115**  
Schimmelbusch

	Ø x H sizes in mm
<b>19-101</b>	80 x 80
<b>19-102</b>	105 x 120
<b>19-103</b>	140 x 140
<b>19-104</b>	160 x 120
<b>19-105</b>	160 x 150
<b>19-106</b>	190 x 150
<b>19-107</b>	190 x 190
<b>19-108</b>	240 x 160
<b>19-109</b>	240 x 240
<b>19-110</b>	290 x 160
<b>19-111</b>	290 x 240
<b>19-112</b>	340 x 160
<b>19-113</b>	340 x 340
<b>19-114</b>	390 x 190
<b>19-115</b>	390 x 290



**19-116**  
Box  
120 x 65 x 13mm  
(without Bulldog clamps,  
without silicone tape)



**19-117**  
Box with support  
120 x 65 x 13 mm  
(ohne Bulldogklemmen)



**19-118**  
Box with support for  
needle electrodes,  
without instruments

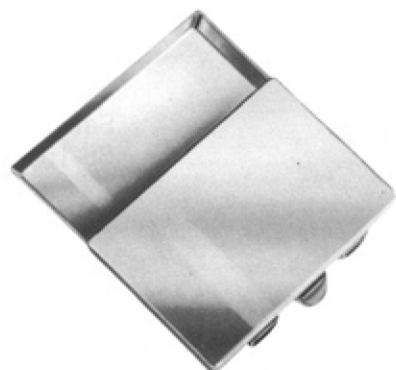

**19-119 - 121**  
50 x 25 x 4,5 mm  
**19-120**  
65 x 42 x 8 mm  
**19-121**  
75 x 25 x 4,5 mm



**19-122**  
Ø 65mm x 15mm



# Hospital Wares



19-123 - 131

	Ø x H
19-123	30 x 90 mm
19-124	50 x 100 mm
19-125	50 x 130 mm
19-126	50 x 175 mm
19-127	75 x 100 mm
19-128	75 x 130 mm
19-129	75 x 175 mm
19-130	100 x 175 mm
19-131	100 x 200 mm



19-141 - 142

- 19-141** Martin Sterilizing Forceps consisting of:  
 1 Sterilizing Forceps, curved, 25 cm, without ratchet, with lid for jar  
 1 jar with bottom plate (anti-tilt)
- 19-142** ditto, with 32 cm long Sterilizing Forceps



19-132 - 139

19-132	165 x 85 x 35 mm
19-133	200 x 100 x 35 mm
19-134	200 x 100 x 50 mm
19-135	230 x 130 x 50 mm
19-136	260 x 150 x 50 mm
19-137	270 x 235 x 50 mm
19-138	300 x 200 x 50 mm
19-139	325 x 275 x 50 mm



19-140  
 205 x 105 x 35 mm

## Round Metal Boxes and Medicine Cups



19-143 - 148

	Ø x H
19-143	75 x 60 mm
19-144	75 x 75 mm
19-145	100 x 60 mm
19-146	100 x 100 mm
19-146A	125 x 80 mm
19-147	125 x 125 mm
19-148	150 x 150 mm



19-149  
25 cc

19-150  
50 cc



19-151  
20 cc  
Medicine Spoon



19-152  
Ø 75 x 12 mm  
Tablet Tray



19-153  
Ø 90 x 90 mm  
Metal Cup



19-154  
Ø 75 x 80 mm  
Sputum Cup

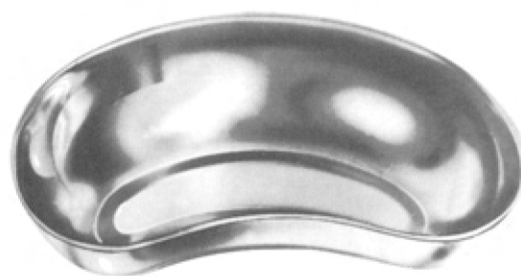

Kidney Dish



19-155 - 157

19-155	170 x 100 x 35 mm
19-156	250 x 140 x 40 mm
19-157	275 x 150 x 45 mm

# Hospital Wares



**19-158 - 165**

	Ø x H		
<b>19-158</b>	40 x 19 mm	0.05L	
<b>19-159</b>	61 x 30 mm	0.07L	
<b>19-160</b>	80 x 40 mm	0.14L	
<b>19-161</b>	116 x 50 mm	0.35L	
<b>19-162</b>	128 x 55 mm	0.45L	
<b>19-163</b>	147 x 65 mm	0.70L	
<b>19-164</b>	167 x 75 mm	1.10L	
<b>19-165</b>	187 x 85 mm	1.60L	

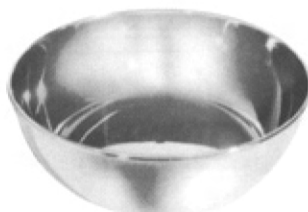

**19-166 - 170**

<b>19-166</b>	116 x 35 mm	0.30L
<b>19-167</b>	128 x 38 mm	0.40L
<b>19-168</b>	147 x 40 mm	0.50L
<b>19-169</b>	157 x 45 mm	0.75L
<b>19-170</b>	187 x 45 mm	1.00L



**19-171**  
Ø 110 x 28 mm 0.15L



**19-172**  
100 cc 0.1L



**19-173 - 176**  
**19-173** 0,25L  
**19-174** 0,50L  
**19-175** 1,00L  
**19-176** 2,00L



**19-177**  
235 x 190 x 40 mm



**19-178**  
Ø 220 x 70 mm

# Hospital Wares



**19-179**  
 Ø 50 x 100 mm  
 Powder Pot



**19-180**  
 Ø 50 x 75 mm  
 Methot With Lid



**19-181**  
 Ø 50 x 75 mm  
 Methot Without Lid



**19-182**



**19-183**



**19-184**

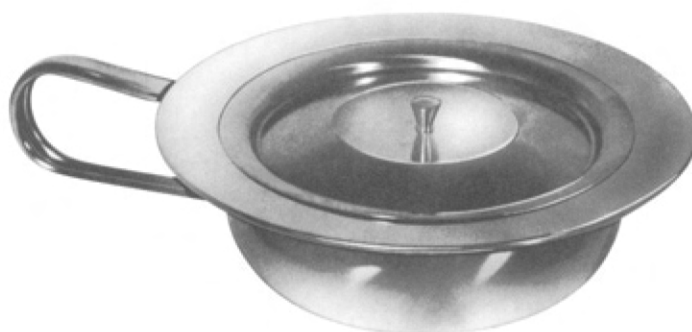

**19-185 - 186**

**19-185** Ø 235 mm  
**19-186** Ø 310 mm



# Needle Cases



**19-187**  
Sauerbruch  
210 x 125 x 17 mm



**19-188**  
Sauerbruch  
210 x 125 x 17 mm



**19-189**  
150 x 95 x 13 mm



**19-190**  
150 x 95 x 13 mm



**19-191**  
150 x 95 x 13 mm



**19-192**  
150 x 95 x 13 mm



**19-193**  
150 x 95 x 13 mm



**19-194**  
150 x 95 x 13 mm



**19-195**  
150 x 95 x 11 mm

# Storing Cases



19-199 - 209

19-199	230 x 130 x 50	mm
19-200	260 x 150 x 50	mm
19-201	275 x 235 x 50	mm
19-202	300 x 200 x 50	mm
19-203	325 x 275 x 50	mm
19-204	420 x 175 x 50	mm
19-205	230 x 130 x 75	mm
19-206	260 x 150 x 75	mm
19-207	300 x 200 x 75	mm
19-208	325 x 275 x 75	mm
19-209	420 x 175 x 75	mm



**19-196**  
Deponette  
245 x 135 x 35mm



**19-197**  
Deponette  
245 x 135 x 50mm



**19-198**  
Deponette  
245 x 135 x 60mm

## Sterilizing Baskets / Trays

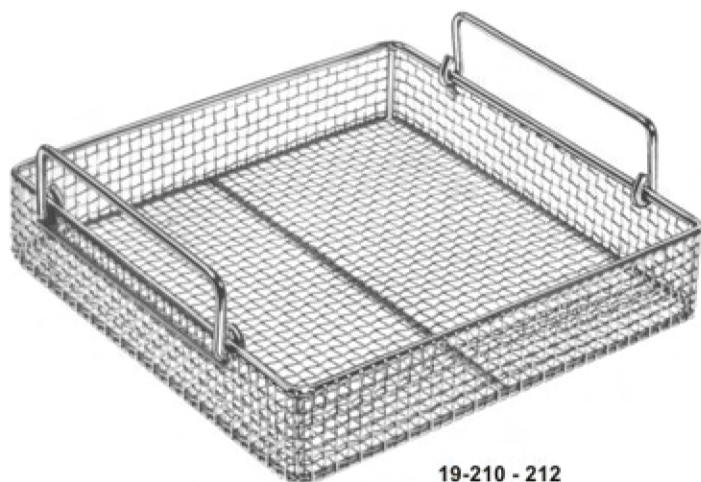

19-210 - 212

19-210	480 x 250 x 50	mm
19-211	520 x 250 x 75	mm
19-212	520 x 250 x 100	mm

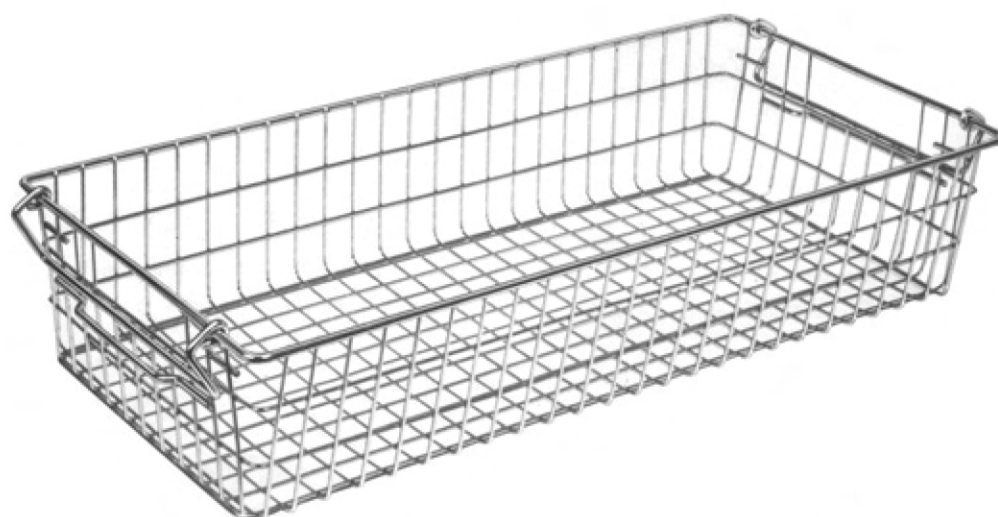

19-219  
(60 x 30 x 15 cm)  
Nominal dimensions



19-213 - 218

19-213	240 x 240 x 50	mm
19-214	240 x 240 x 80	mm
19-215	240 x 240 x 100	mm
19-216	480 x 260 x 50	mm
19-217	520 x 260 x 80	mm
19-218	520 x 260 x 100	mm



## Scissors with Tungsten Carbide Inserts

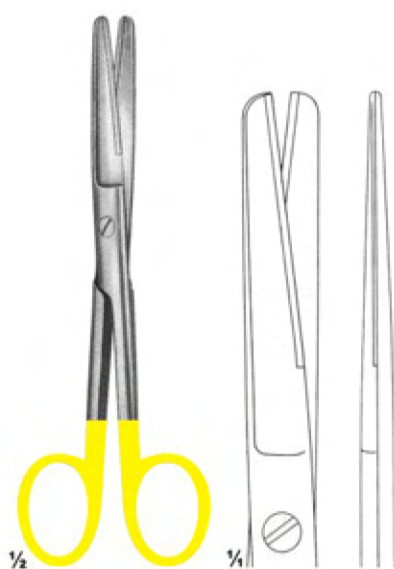

**26-101**  
Standard

14,5cm  
16,5cm  
18,5cm



**26-102**  
Standard

14,5cm  
16,5cm  
18,5cm

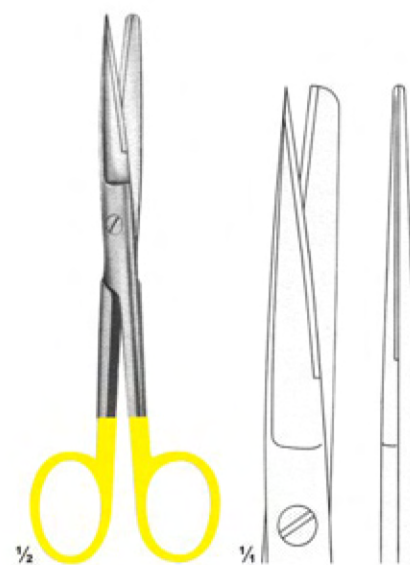

**26-103**  
Standard

14,5cm  
16,5cm  
18,5cm

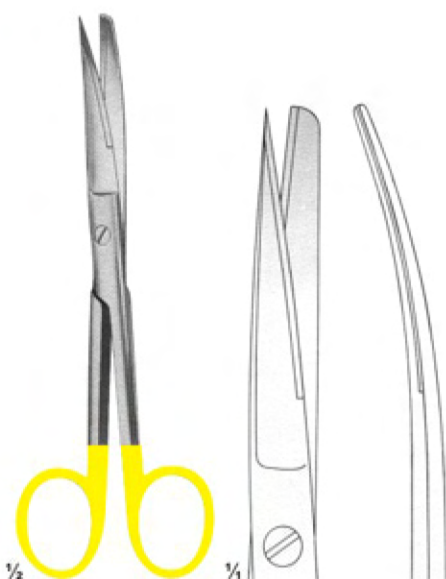

**26-104**  
Standard

14,5cm  
16,5cm  
18,5cm

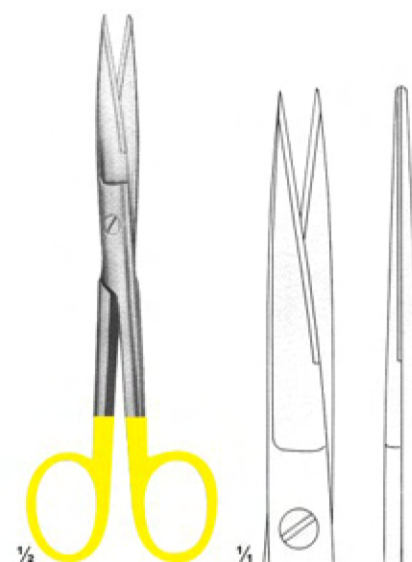

**26-105**  
Standard

14,5cm  
16,5cm  
18,5cm



**26-106**  
Standard

14,5cm  
16,5cm  
18,5cm



## Scissors with Tungsten Carbide Inserts

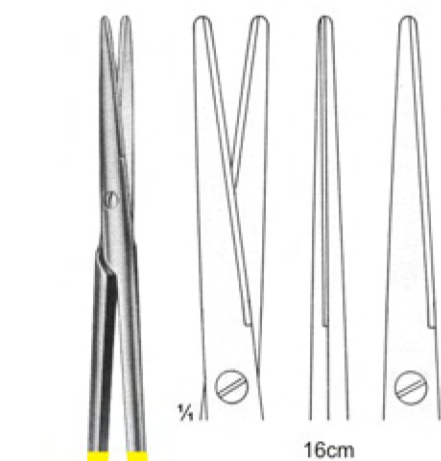

16cm

$\frac{1}{2}$   
26-107  
Mayo-Lexer

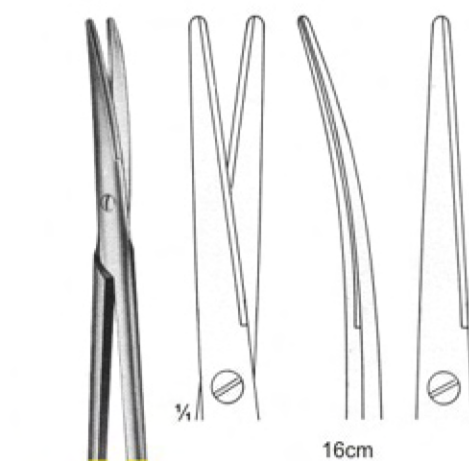

16cm

$\frac{1}{2}$   
26-108  
Mayo-Lexer

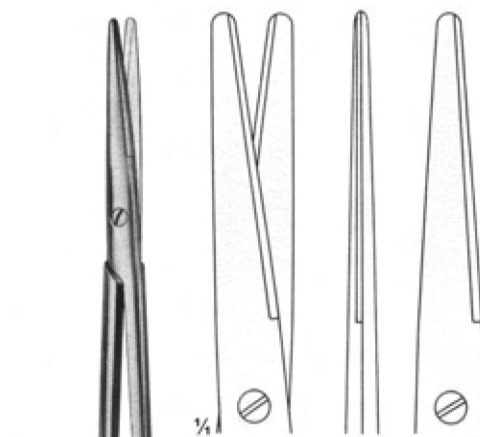

16cm  
21cm

$\frac{1}{2}$   
26-109  
Lexer

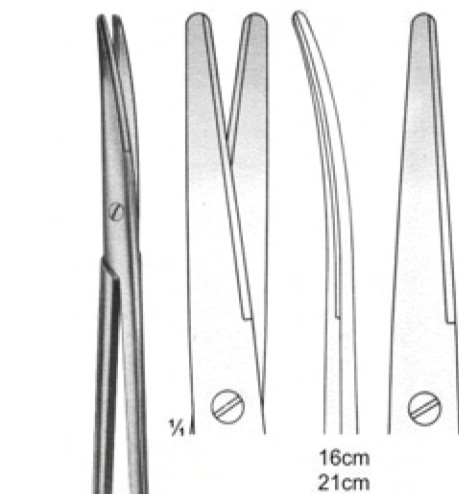

16cm  
21cm

$\frac{1}{2}$   
26-110  
Lexer

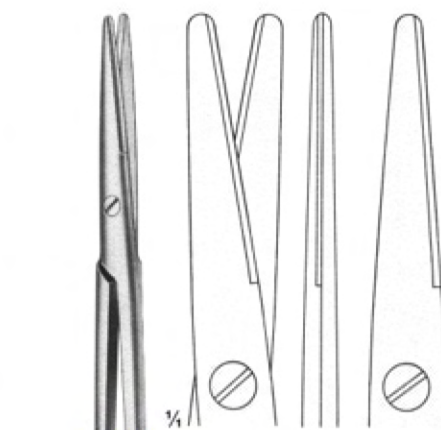

15cm  
17cm

$\frac{1}{2}$   
26-111  
Mayo-Stille



15cm  
17cm

$\frac{1}{2}$   
26-112  
Mayo-Stille

# Scissors with Tungsten Carbide Inserts

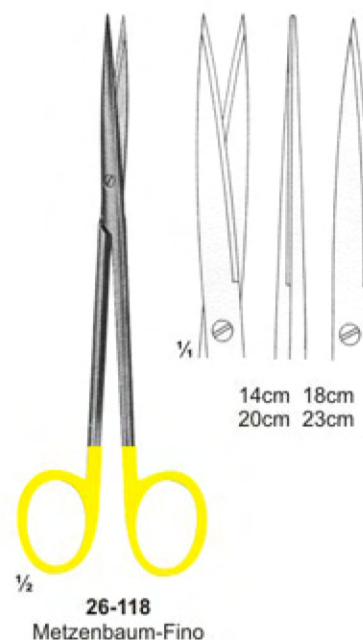
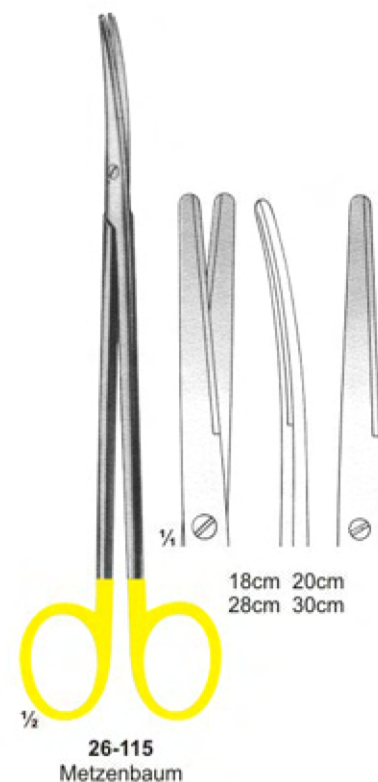
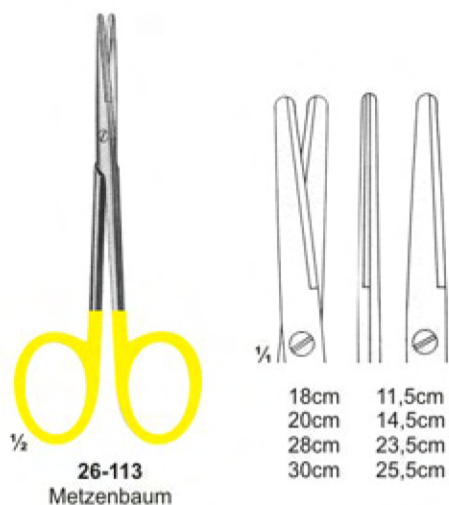

## Scissors with Tungsten Carbide Inserts

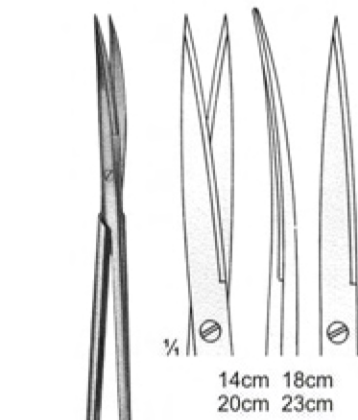

1/2  
**26-119**  
Metzenbaum-Fino

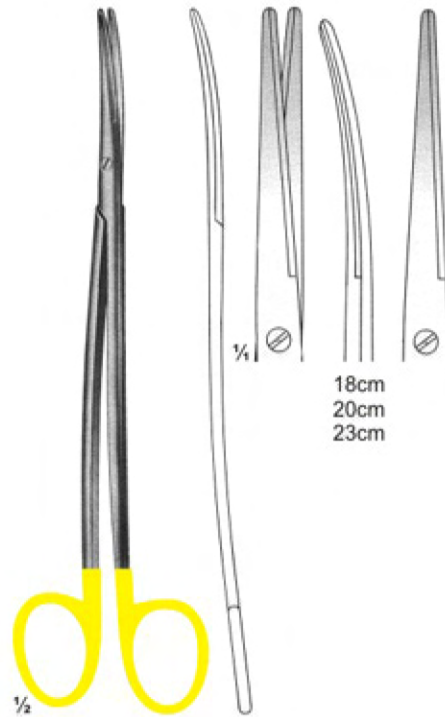

1/2  
**26-120**  
Metzenbaum-Fino

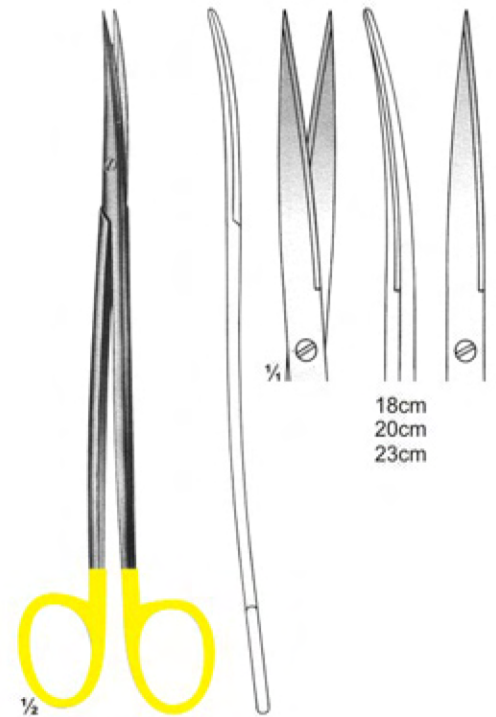

1/2  
**26-121**  
Metzenbaum-Fino

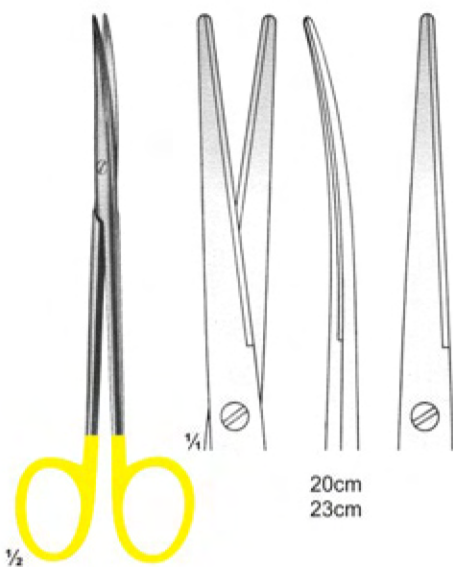

1/2  
**26-122**  
Metzenbaum

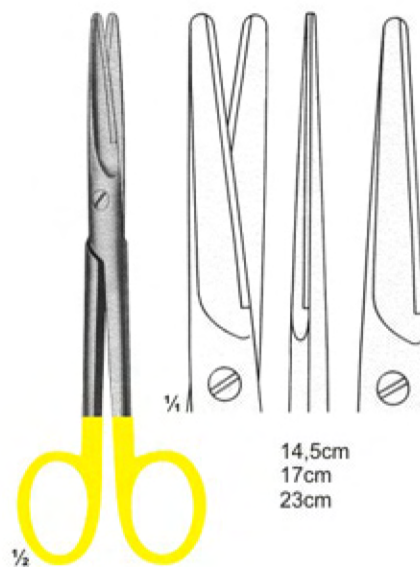

1/2  
**26-123**  
Mayo

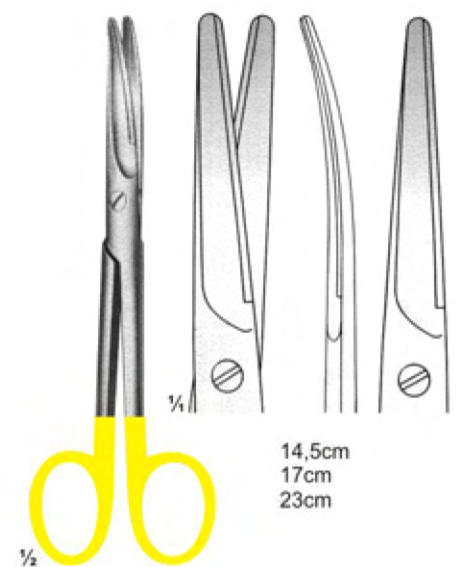

1/2  
**26-124**  
Mayo

## Scissors with Tungsten Carbide Inserts

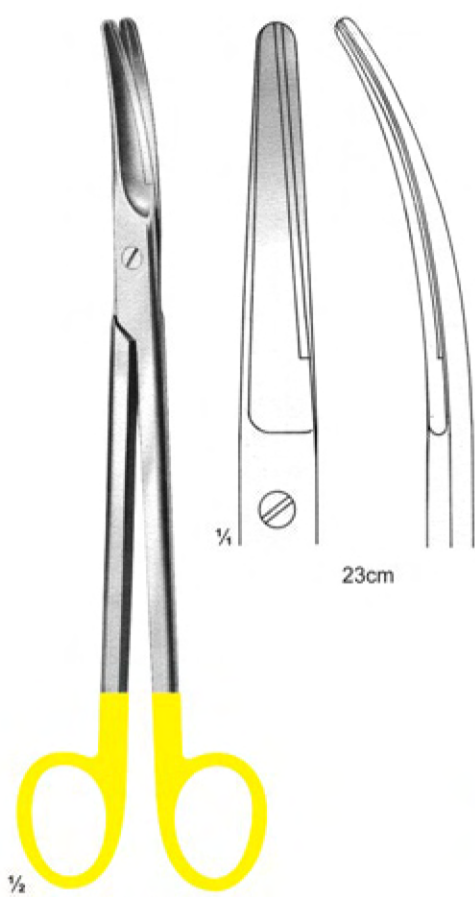

**26-125**  
Parametrium

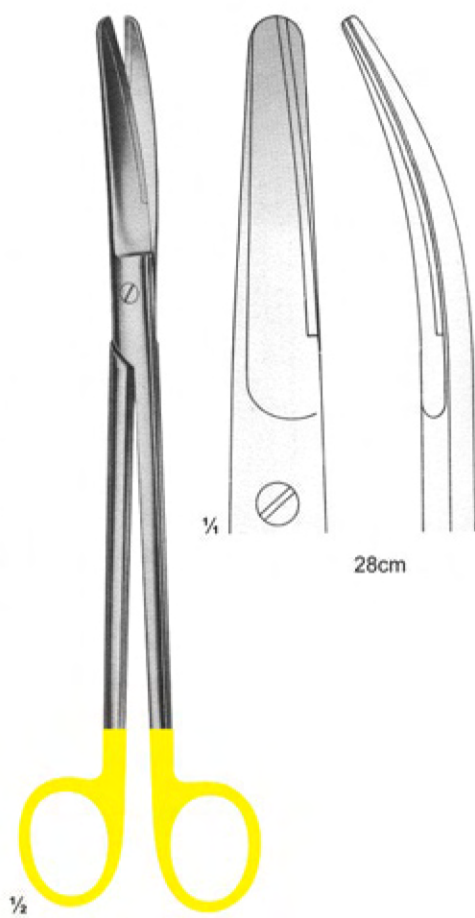

**26-126**  
Mayo-Harrington

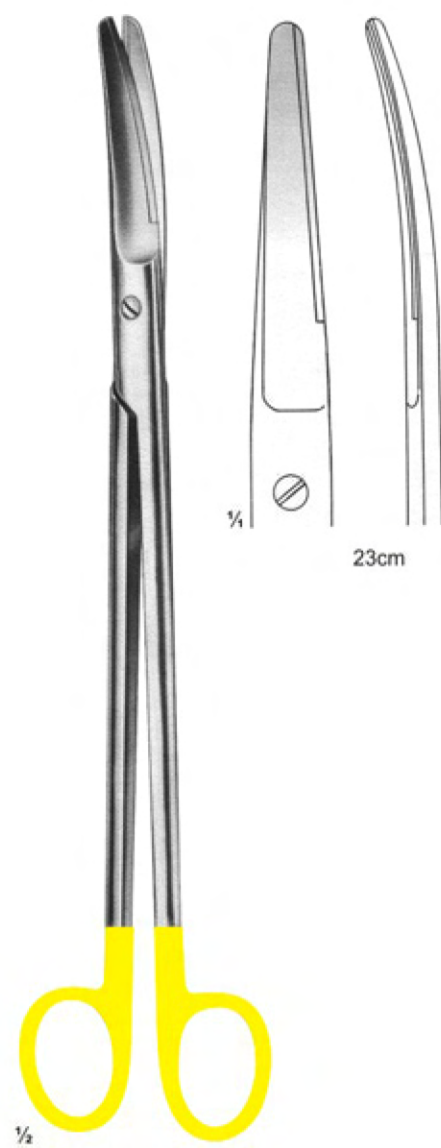

**26-127**  
Sims



# Scissors with Tungsten Carbide Inserts

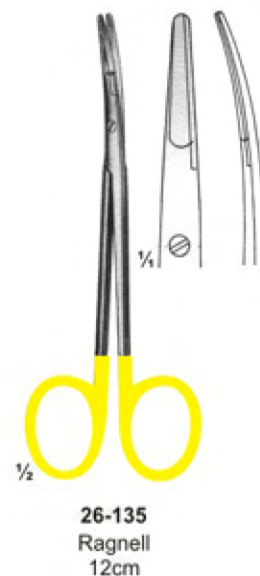
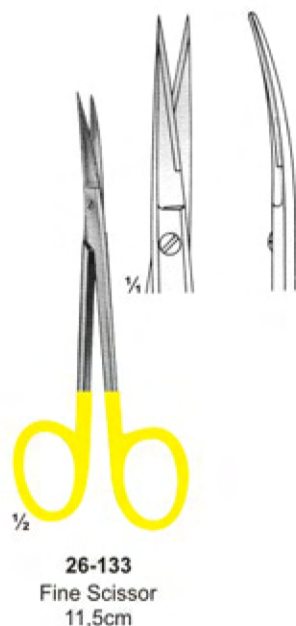
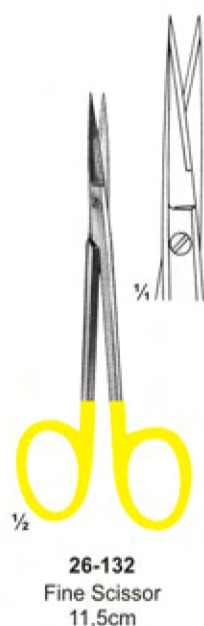
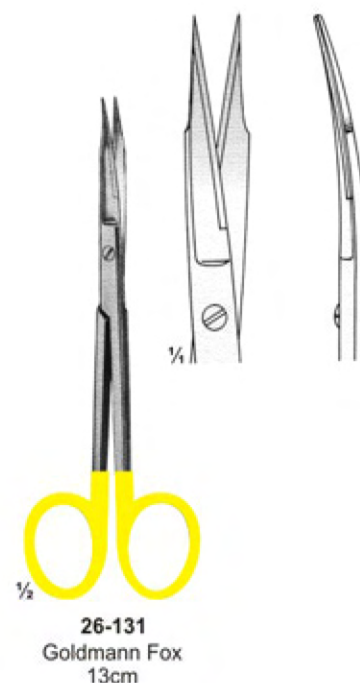
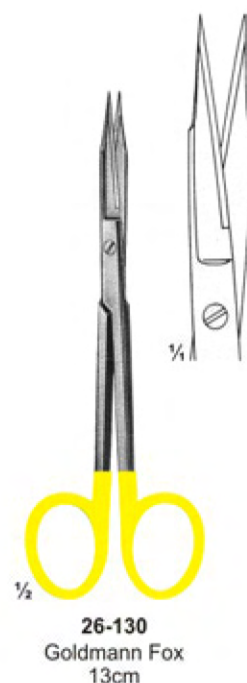
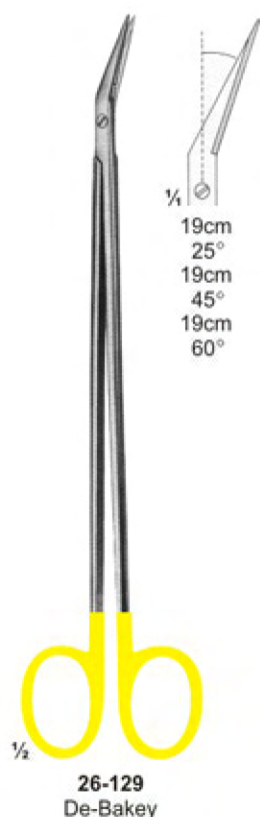
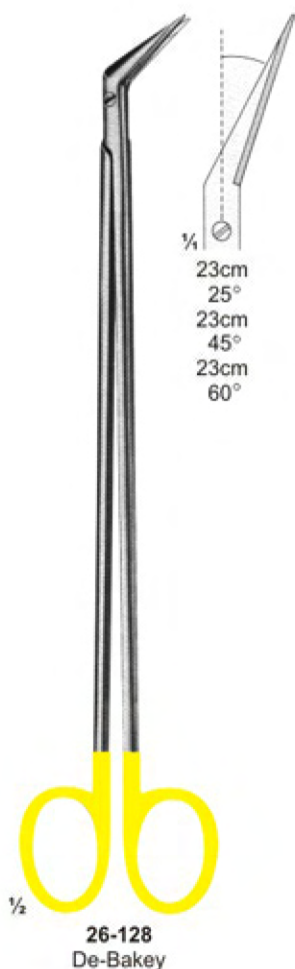

# Scissors & Dissecting Forceps with Tungsten Carbide Inserts

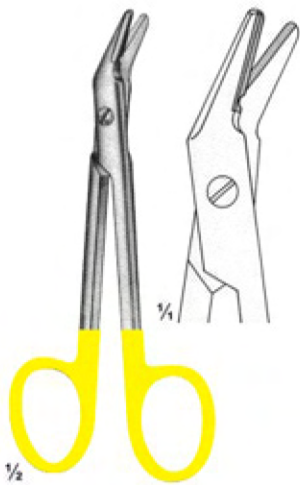

**26-136**  
Universal  
12cm



**26-137**  
Ligature Scissors  
1 Black & 1 Goldplated ring

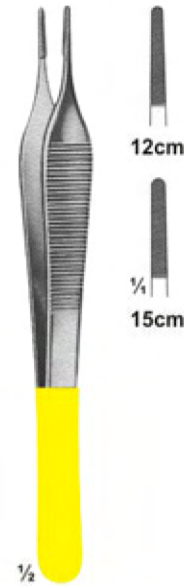

**26-138**  
Adson

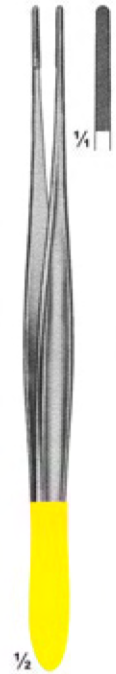

**26-139**  
Cushing  
17,5cm

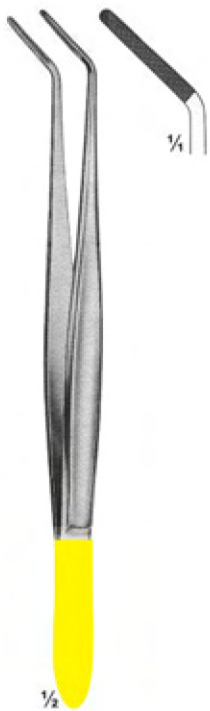

**26-140**  
Cushing  
18cm



**26-141**  
Cushing-Taylor  
18cm



**26-142**  
Dissecting Forceps  
15cm



**26-143**  
Semken  
15cm

# Dissecting Forceps and Needle holders with

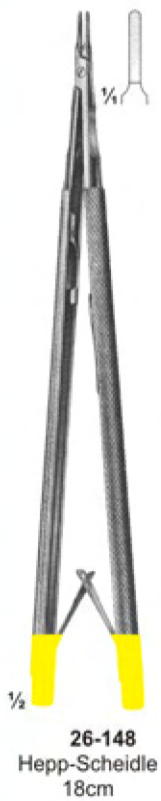
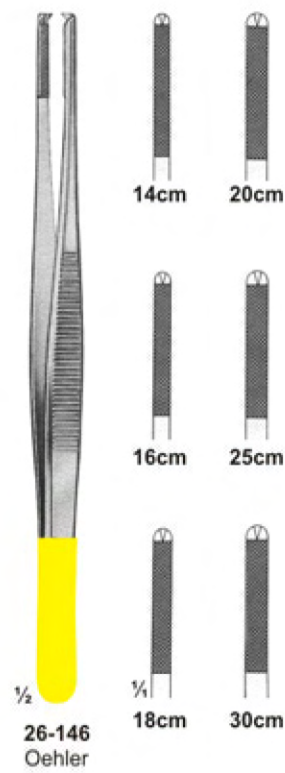
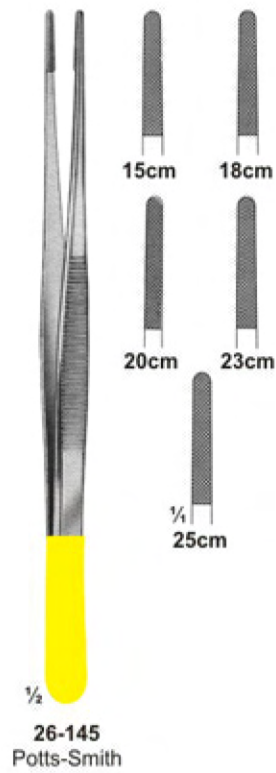
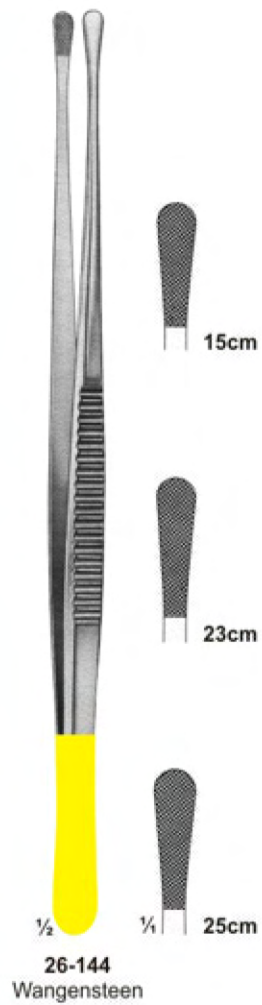

# Needle holders with Tungsten Carbide Inserts



**26-152**  
Arruga  
16cm

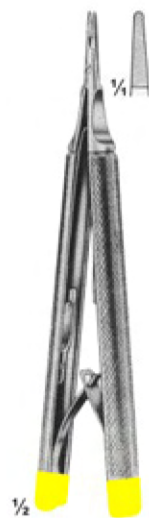

**26-153**  
Castroviejo  
13cm

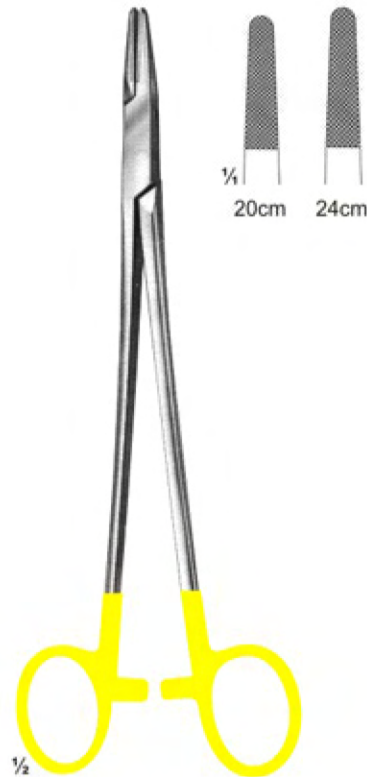

**26-154**  
Hegar  
20cm 24cm

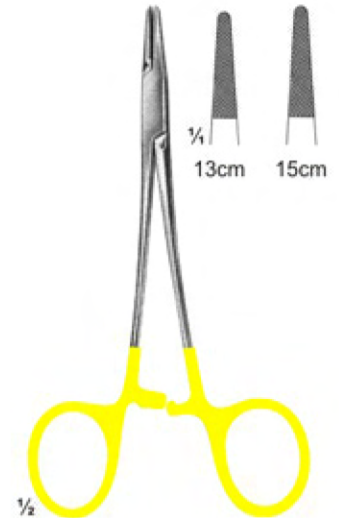

**26-155**  
Halsey  
13cm 15cm



**26-156**  
Mayo-Hegar  
16cm 18cm 20cm  
24cm 26cm 30cm

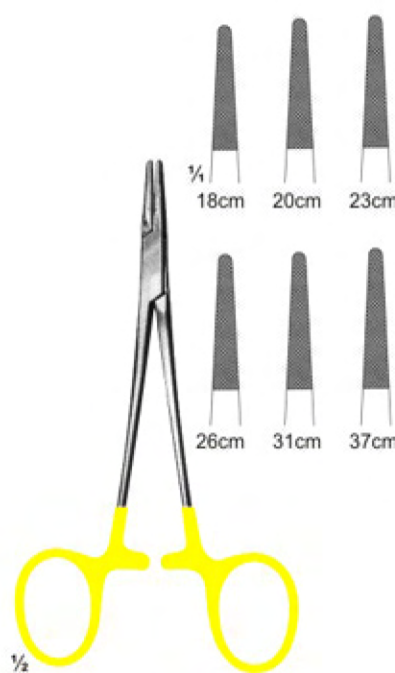

**26-157**  
De-Bakey  
18cm 20cm 23cm  
26cm 31cm 37cm

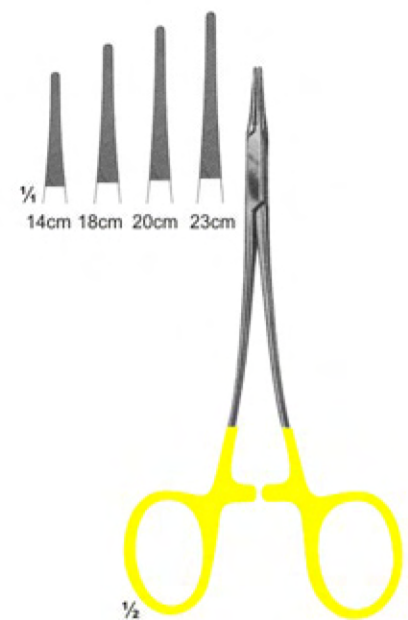

**26-158**  
Hegar-Vascular  
14cm 18cm  
20cm 23cm



# Needle holders with Tungsten Carbide Inserts

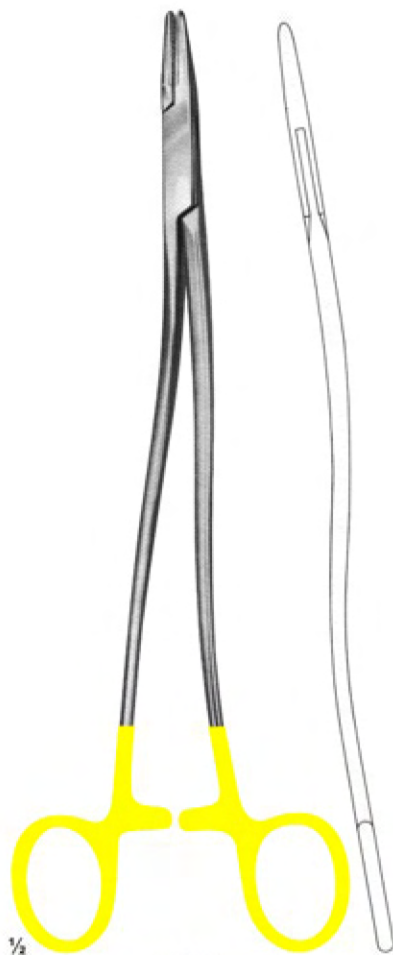

1/2  
**26-159**  
Bozemann-Wertheim  
20cm 24cm 26cm

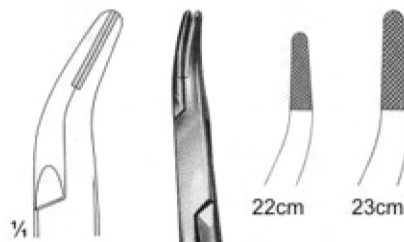

1/2  
**26-160**  
Stratte  
22cm 23cm

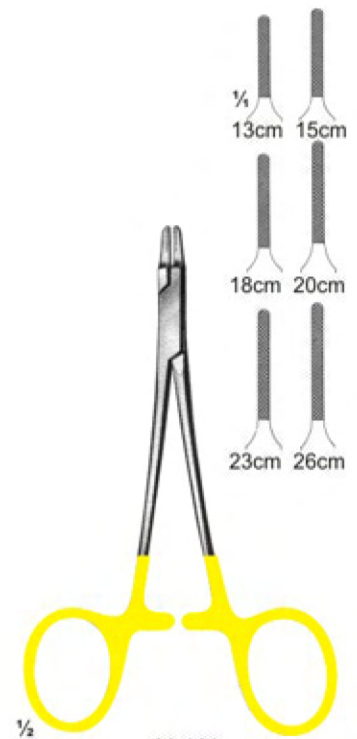

1/2  
**26-161**  
Ryder  
13cm 15cm 18cm  
20cm 23cm 26cm



1/2  
**26-162**  
Ryder-Vascular  
13cm 15cm 18cm  
20cm 23cm 26cm



1/2  
**26-163**  
Martin  
15cm 17cm 20cm



1/2  
**26-164**  
Sarat  
18cm 20cm 26cm

# Needle holders with Tungsten Carbide Inserts

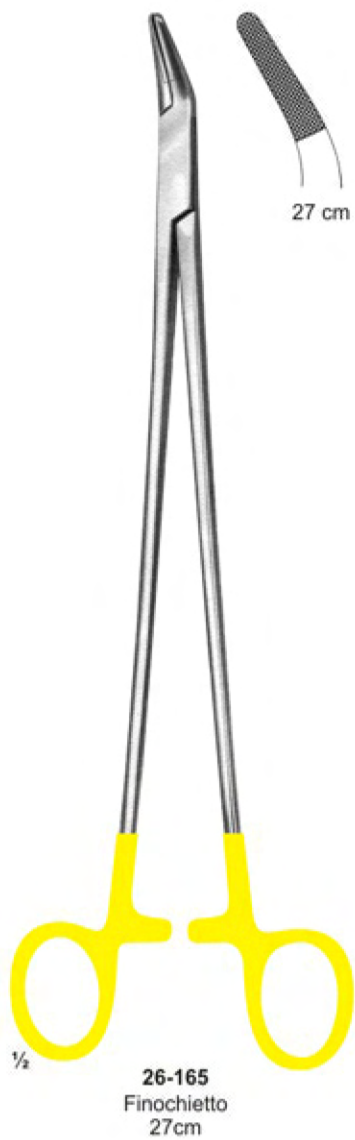

# Needle holders with Tungsten Carbide Inserts



1/2  
**26-172**  
 Mathieu-Ryder  
 17cm  
 20cm 24cm



1/2  
**26-173**  
 Lichtenberg  
 20cm



1/2  
**26-174**  
 Langhals  
 20cm 25cm



1/2  
**26-175**  
 Lichtenberg  
 20cm 25cm



1/2  
**26-176**  
 Luehty-Beck  
 20cm 25cm



1/2  
**26-177**  
 Luehty-Beck  
 20cm 25cm



1/2  
**26-178**  
 Langebeck  
 18cm  
 20cm 23cm

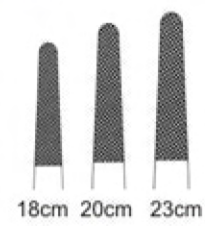

18cm 20cm 23cm



1/2  
**26-179**  
 Langebeck-beck  
 18cm  
 20cm 23cm

# Wire Cutting Plier With T.C. Inserts



**26-180**  
TOENNIS  
Elastic pattern for  
dura-or intestinal suture  
180 mm



**26-181**  
Cutting Plier  
12 cm

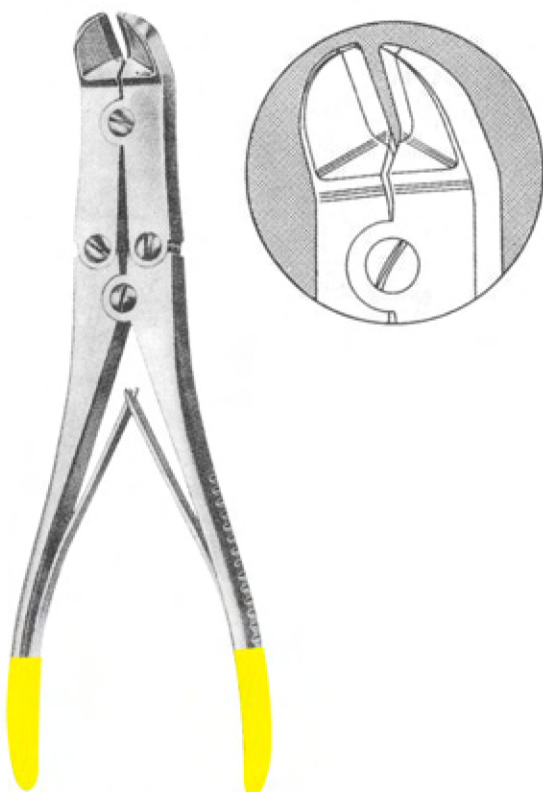

**26-182**  
MULLAR CLAUS  
22 cm



**26-183**  
Plier  
17.5 cm





## OUR STORY

Scissor Town is located at Sialkot-Pakistan is Specialized in Manufacturing wide range of Surgical, Dental ,and beauty care Instruments with 42 years of well experienced history .

Scissor Town is Well Organized, skilful & efficient group of people at Scissortown are controlling the production with latest techniques and machinery to achieve Excellent quality.

We welcome you to check our quality and compare with your present suppliers. We are sure you will find our quality and service best. Our Aim Scissortown has earned the credit to get entire satisfaction of World Wide customers by providing, Quality products, Competitive Prices, In time Deliveries, Standard packaging. Customer is always right!

### HEAD OFFICE :

#### SCISSORS TOWN

Barath S.P.O Bharath Gondal Road,  
Sialkot 51310 Pakistan

**Tel : +92-524-266575**

**Fax : +92-524-271272**

**Cell : +92-300-8614515**

**Email: imran@scissortown.com**

### SALES AND MARKETING OFFICE :

#### TORONTO REGION

Unit # 1203, 10 Edgecliff Golfway  
North York, ON, M3C, 3A3 Canada

**Tel : +92-524-266575**

**Tel : +1-416-270-1818**

**Fax : +1-416-546-8096**

**E-mail: sales@scissortown.com**

### SALES AND MARKETING OFFICE :

#### DURHAM REGION

Unit #12, 1790 Finch Ave Pickering,  
ON, L1V 0A1 Canada

**Tel : +1-647-774-3877**

**Fax : +1-905-427-1614**

**Email : sales@scissortown.com**